

## Eliminate ALL Areas of Unwanted Movement in the Parallel Arms!

Worn parallel linkage arms and bushings are a common problem with today's planters. Since the implementation of down-pressure enhancing products, this problem has only gotten worse.

The PPS Premium Complete Parallel Arm Kits, which come with upper and lower parallel arms **with pre-installed bushings**.

(Eliminates ALL areas of unwanted movement in the arms.)

### The Best Option for Optimal Planter Repair



- PPS arms are laser cut, robotically welded, and built in Missouri. They are purposely built robust to withstand the effects of hydraulic down pressures and high-speed planting.
- The two-bushing system, brought to the market by Precision Planter Solutions, includes:
  1. Hardened flange bushings that come preinstalled into the parallel arms. These bushings increase the surface area of the wear zone to provide unmatched durability and life expectancy.
  2. Internal pivot bushings that thread onto the bolts, locking them into place eliminating the "slop" associated with smooth bushings. These hex headed bushings are also hardened to increase wearability.



Shouldered Bolts



Hex Bushing

Flange Bushing

- All wear takes place on replaceable components instead of on the parallel arms themselves.
- Less planter maintenance for long-term cost reduction.
- You no longer have to worry about the tedious task of replacing a broken cast arm, within crucial planting windows, due to excessive down pressures in adverse planting conditions.



Case-IH



John Deere



Kinze



Precision Planting



White



# PPS COMPLETE PARALLEL ARM KITS

## Premium Complete Arm Rebuild Kits:

To ensure OPTIMAL fit, especially where worn support plate and row unit holes are prevalent, premium arm kits include 11/16" shouldered 5/8" bolts as part of the hardware package. You will need an 11/16" reamer to enlarge the planter support plate and row unit.



## No-Ream Complete Arm Rebuild Kits:

This is an option available for customers who prefer not to ream the support plate and row unit holes. These rebuild kits come with parallel arms and shoulder-less bolts. They are ideal for narrow row planters and econo-fold planters where clearance around support plates is exceptionally tight.

## Premium Arm Kits or No-Ream Arm Kits

### John Deere

Model	Row Unit	Arm Length	Parallel Arm/Support Plate Mounting	Premium Arm Kits		No-Ream Arm Kits	
7000, 7100	MaxEmerge	16"	parallel arms mount on outside of support plate	PPK213611	\$300.00	PPK214611	\$300.00
7200, 7300	MaxEmerge 2 with 1.6 Bushel Fiberglass Box *	16"	parallel arms mount on inside of support plate	PPK223321	\$335.00	PPK224321	\$335.00
7200, 7300, 1700, DB	MaxEmerge 2 with Poly Boxes * MaxEmerge Plus Pro-Series MaxEmerge XP Pro-Series XP	16"	parallel arms mount on inside of support plate	PPK263321	\$335.00	PPK264321	\$335.00
			parallel arms mount on outside of support plate	PPK263221	\$335.00	PPK264221	\$335.00
		23"	parallel arms mount on inside of support plate	PPK263521	\$440.00	PPK264521	\$440.00
			parallel arms mount on outside of support plate	PPK263421	\$440.00	PPK264421	\$440.00
1705, DB	MaxEmerge 5 ExactEmerge	16"	parallel arms mount on inside of support plate	PPK273321	\$335.00	PPK274321	\$335.00
			parallel arms mount on outside of support plate	PPK273221	\$335.00	PPK274221	\$335.00
		23"	parallel arms mount on inside of support plate	PPK273521	\$440.00	PPK274521	\$440.00
			parallel arms mount on outside of support plate	PPK273421	\$440.00	PPK274421	\$440.00

### Optional Accessories

**Product ID Price**

Support Plate Cylinder Bracket with hardware. Installed on row unit support plate for top of DeltaForce cylinder.

PPS299823 \$62.00

Parallel Arm Cylinder Bracket with hardware. Installed on the lower parallel arm for bottom of DeltaForce cylinder.

PPS299923 \$110.00

\*Planters running MaxEmerge 2 row units with OEM down pressure springs that have brackets that bolt in the same holes as the parallel arms on the support plate requires a modified kit. Call 1-800-368-7773 for details.

Any make planters running Dawn GFX, Precision Planting Reveal, or similar row cleaners may require a modified kit. Call 1-800-368-7773 for details.

Planters running 15" spacing with row units on same toolbar will require modified kit. Call 1-800-368-7773 for details

### Bit Package - Premium Arm Kits

**Product ID**

**Price**

11/16" Bit Package - John Deere, Kinze, AGCO

PPS688011

\$56.00

# PREMIUM ARM KITS OR NO-REAM ARM KITS

## Case-IH

Model	Down Pressure System	Arm Length	Premium Arm Kits	No-Ream Arm Kits
800, 900, 950, 955	2 spring down pressure	14"	PPK014411 \$335.00	PPK013411 \$335.00
		20"	PPK014511 \$360.00	PPK013511 \$360.00
1200, 1205	1 spring or air down pressure	14"	PPK014211 \$335.00	PPK013211 \$335.00
		20"	PPK014311 \$365.00	PPK013311 \$365.00
	2 spring down pressure	14"	PPK014411 \$335.00	PPK013411 \$335.00
		20"	PPK014511 \$360.00	PPK013511 \$360.00
	DeltaForce, built in lower cylinder bracket. (upper cylinder brackets available below)	14"	PPK014611 \$390.00	-
		24" *	PPK014911 \$580.00	-
	SureForce, built in lower cylinder bracket (upper cylinder brackets available below)	14"	PPK014711 \$335.00	-
		24"	PPK014811 \$480.00	-
Case-IH Premium Arm Kits require the lower holes in the support plate and row unit to be reamed to 11/16"				
* PPK014911 24" DeltaForce kit includes a 10" setback bracket and 14" Parallel Arms to allow for use of DeltaForce on spl't rows.				

### Optional Accessories

	Product ID	Price
DeltaForce Upper Cylinder Bracket Kit, cost savings on new DeltaForce installs	PPS005912	\$63.00
SureForce Upper Cylinder Bracket Kit, cost savings on new SureForce installs	PPK851150	\$87.00
Heavy-Duty Front Support Plate, robust plate that can be used with Premium Arm Kits	PPS005915	\$128.00

## Kinze

Model	Down Pressure System	Arm Length	Premium Arm Kits	No-Ream Arm Kits
2000 Series: Standard Row/Pull Units	Spring Down Pressure	16"	PPK413211 \$315.00	PPK414211 \$315.00
	DeltaForce	16"	PPK413211.01 \$340.00	-
2000 Series: Split Row/Push Unit	Spring Down Pressure	16"	PPK423211 \$360.00	PPK424211 \$360.00
3000 Series: Standard Row/Pull Units	Spring, OEM Pneumatic Down Pressure	16"	PPK433211 \$315.00	PPK434211 \$315.00
	DeltaForce	16"	PPK433211.01 \$340.00	PPK434211.01 \$340.00
	SureForce	16"	PPK433211.02 \$340.00	PPK434211.02 \$340.00
3000 Series: Split Row/Push Unit	Spring, OEM Pneumatic Down Pressure	16"	PPK443211 \$360.00	PPK444211 \$360.00
	DeltaForce	16"	PPK443211.01 \$390.00	PPK444211.01 \$390.00
	SureForce	16"	PPK443211.02 \$390.00	PPK444211.02 \$390.00
<b>Optional Accessories</b>			<b>Product ID</b>	<b>Price</b>
Setback Bracket, replacement for excessively worn OEM brackets. Made with 11/16" holes for shouldered bolt			PPS005912	\$63.00

## AGCO - Massey Ferguson / Precision Planting / White

Model	Parallel Arm Style	Arm Length	Premium Arm Kits	No-Ream Arm Kits
6000, 8000 Series	Standard Arm	16" Red	PPK613211 \$335.00	PPK614211 \$335.00
9000 Series 2021 & Prior (2" tall red arms with 7/8" pivot bushing)	Standard Arm	16" Red	PPK623211 \$335.00	PPK624211 \$335.00
	Built-in DeltaForce bracket	16" Gray	PPK623311 \$410.00	PPK624311 \$410.00
9000 Series 2022 & After (2-5/16" tall gray arms with 29.5mm pivot bushing)	Built-in DeltaForce bracket	16" Gray	PPK643411 \$410.00	PPK644411 \$410.00
PP Ready Row Unit 1.0 (2" tall gray arms with 7/8" pivot bushing)	Standard, Reuse Original DeltaForce Bracket	16" Gray	PPK633311 \$335.00	PPK634311 \$335.00
	Built-in DeltaForce bracket	16" Gray	PPK623311 \$410.00	PPK624311 \$410.00
PP Ready Row Unit 2.0 (2-5/16" tall gray arms with 29.5mm pivot bushing)	Built-in DeltaForce bracket	16" Gray	PPK643411 \$410.00	PPK644411 \$410.00
Any make planters running Dawn GFX, Precision Planting Reveal, or similar row cleaners may require a modified kit. Call 1-800-368-7773 for details.				
Planters running 15" spacing with row units on same toolbar will require modified kit. Call 1-800-368-7773 for details				

### Bit Package - Premium Arm Kits

	Product ID	Price
11/16" Bit Package - John Deere, Kinze, Precision Planting, White	PPS688011	\$56.00
11/16" Bit Package - Case-IH	PPS688012	\$78.00



# PPS FLANGE BUSHING KITS

Rebuild Your Existing Parallel Arms Kits

**Make Your Current Parallel Linkage Arms Better than New!**

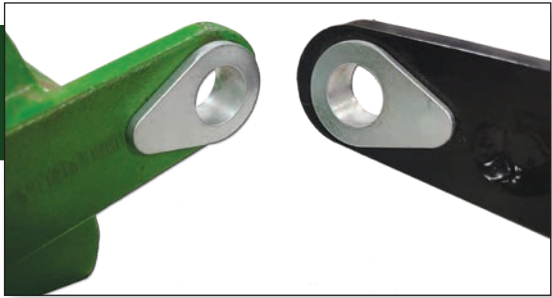

**Stop the Slop!**



**Full Rebuild Kits**  
(Using Your Current Arms)

**Excellent Option for Reduced Costs!**

**Eliminate ALL Areas of Unwanted Movement in the Parallel Arms!**

The PPS Flange Bushing “Rebuild Your Own” kits for planters make your old and worn parallel linkage arms better than new! **All of the wear takes place on replaceable parts instead of on your planter’s parallel linkage arms.**

Worn parallel linkage arms and bushings are a common problem with today’s planters. Since the implementation of down-pressure enhancing products, this problem has only gotten worse. In the past, worn parallel linkage arms and bushings have always had to be replaced with new ones. With the PPS Flange Bushing “Rebuild Your Own” Kits, there is no longer any wear on the parallel linkage arms. All of the wear is on the kit’s replaceable parts. These parts include a hardened flange bushing and a threaded hex bushing that fits into the flange bushing. The installer reams out the existing worn hole in the arm a little larger for a more precise fit for the bushings.

- Excellent option for reduced costs
- Two-bushing system, with increased surface area, collectively prolongs wear life
- Eliminates parallel arm wear
- Less planter maintenance for long-term cost reduction
- Shouldered bolts are included for optimal fit in worn support plate and row unit holes

Flange Bushing



Hex Bushing



John Deere  
(PPK281131)



Case-IH / New Holland  
(PPK011111)

# PPS "REBUILD-YOUR-EXISTING" KITS

## For Parallel Linkage Arms



### Case-IH / New Holland

Model	Down Pressure Type	Description	Product ID	Price/Row	Bit Pack	Price/Pk
800, 900, 955, 5400SS, 5500SS	Pneumatic or Spring Down Pressure	1-1/16" Repair	PPK011111	\$145.00	PPS688049	\$168.00
1200/1205 Series	Pneumatic or Spring Down Pressure	1-1/16" Repair	PPK011111	\$145.00	PPS688049	\$168.00
	DeltaForce or SureForce (lower holes in support plate and row unit get reamed)	1-1/16" Repair	PPK012111	\$145.00	PPS688120	\$225.00
2000 Series	Planters that have worn through nylon bushing into parallel arm holes	Oversized Bushing	PPK022000	\$109.00	PPS688021	\$133.00
	Planters that have not worn through nylon bushings & show no wear in parallel arm holes	Standard Bushing	PPK021000	\$109.00	n/a	n/a

### Great Plains

Model	Bushing Type	Description	Product ID	Price/Row	Bit Pack	Price/Pk
Great Plains	Planters with green nylon bushings	Bushing Kit	PPK811000	\$93.00	n/a	n/a

### John Deere

Model	Row Unit	Description	Product ID	Price/Row	Bit Pack	Price/Pk
7000, 7100	MaxEmerge	1-1/16" Repair	PPK211111	\$145.00	PPS688116	\$205.00
7200, 7300	MaxEmerge 2, Fiberglass Boxes *(see yellow notation below)	1-3/16" Repair	PPK221131	\$145.00	PPS688316	\$235.00
	MaxEmerge 2, Poly Boxes *(see yellow notation below),	1-3/16" Repair	PPK281131	\$145.00	PPS688316	\$235.00
7200, 1700, DB	MaxEmerge Plus, Pro-Series, Max Emerge XP, ProSeries XP	1-3/16" Repair	PPK281131	\$145.00	PPS688316	\$235.00
1705, DB	MaxEmerge 5, ExactEmerge	1-3/16" Repair	PPK271131	\$145.00	PPS688316	\$235.00

### Kinze

Model	Row Unit	Down Pressure Type	Description	Product ID	Price/Row	Bit Pack	Price/Pk
2000 Series	Standard Row/Pull Unit	Spring Down Pressure	1-1/16" Repair	PPK411111	\$145.00	PPS688116	\$205.00
		DeltaForce	1-1/16" Repair	PPK411111.01	\$145.00	PPS688116	\$205.00
	Split Row, Push Unit	Spring Down Pressure	1-1/16" Repair	PPK421111	\$145.00	PPS688116	\$205.00
3000 Series	Standard Row/Pull Unit	Spring, OEM Pneumatic Down Pressure	1-1/16" Repair	PPK431111	\$145.00	PPS688116	\$205.00
		DeltaForce	1-1/16" Repair	PPK431111.01	\$145.00	PPS688116	\$205.00
		SureForce	1-1/16" Repair	PPK431111.02	\$145.00	PPS688116	\$205.00
	Split Row, Push Unit	Spring, OEM Pneumatic, DeltaForce or SureForce	1-1/16" Repair	PPK441111	\$145.00	PPS688116	\$205.00
4900 Series	Standard Row Unit	All Down Pressure Types	1-1/16" Repair	PPK452111	\$145.00	PPS688049	\$168.00

### Optional Accessories

Setback Brackets, replacement for excessively worn OEM brackets. Made with 11/16" holes for shouldered bolt.

Product ID	Price
PPS005912	\$63.00

### AGCO - Massey Ferguson / Precision Planting / White

Model	Description	Product ID	Price/Row	Bit Pack	Price/Pk
5000, 6000, 8000 Series	1-1/16" Repair	PPK611111	\$145.00	PPS688116	\$205.00
9000 Series 2021 & Prior (7/8" OEM pivot bushings red parallel arms)	1-1/16" Repair	PPK621111	\$145.00	PPS688116	\$205.00
9000 Series 2022 & After (2-5/16" tall gray arms with 29.5mm pivot bushing) NEW OEM ARMS ONLY	1-3/16" Repair	PPK641131	\$145.00	PPS688316	\$235.00
Precision Planting Ready Row Unit 1.0 (7/8" OEM pivot bushings parallel arms)	1-1/16" Repair	PPK631111	\$145.00	PPS688116	\$205.00

\*MaxEmerge 2 row units equipped with down pressure spring brackets that bolt in the same holes as the parallel arms on required special kits, call for details.

Any make planters running Dawn GFX, Precision Planting Reveal, or similar row cleaners may require a modified kit. Call 1-800-368-7773 for details.

Any make planters running 15" spacing with row units on same toolbar will require modified kit. Call 1-800-368-7773 for details



# PPS CLOSING WHEEL BRACKET KITS

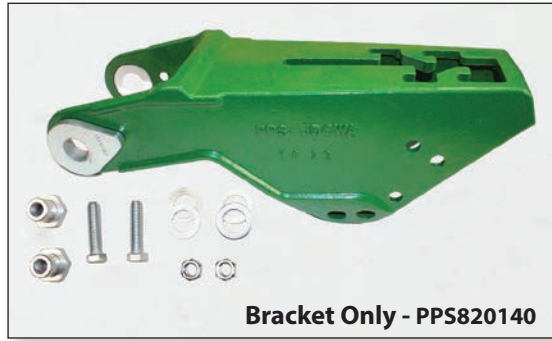
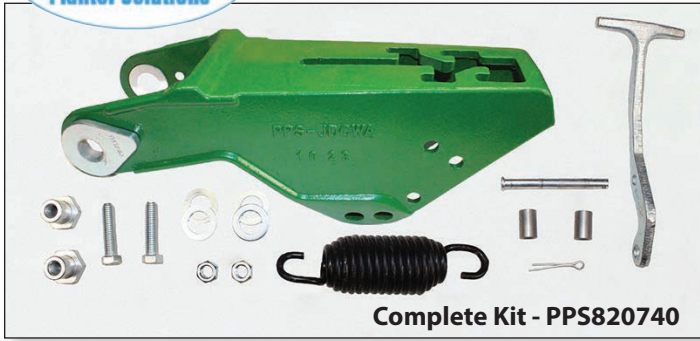

PPS Closing Wheel Arm Complete Kits and Bracket Only for John Deere				
John Deere	Description	Product ID	Price/Row	
MaxEmerge2, MaxEmerge Plus, Max-Emerge Pro, MaxEmerge XP, Pro-Series XP, MaxEmerge5, ExactEmerge	Complete Kit	Includes: bracket, hardware, spring, handle, & pin	PPS820740	\$165.00
	Bracket Only	Includes: bracket & hardware. Reuse spring, handle & pin	PPS820140	\$130.00
Brackets will use 5/8" (16mm) bolt-on style closing wheels. MaxEmerge 2 row units will require a closing wheel with an updated bearing.				
Stop Mount with extended wear spring hole bushing			PPS025624	\$50.00

## PPS CAST CLOSING WHEEL BRACKET REPAIR KIT & SPRING HOLE REPAIR BUSHING



John Deere	Product ID	Prc/Row	Bit Package	Price/Pack
Cast closing wheel bracket; 1-11/16" repair kit	PPS840170	\$25.00	PPS688111	\$265.00
Spring hole bushing; 11/16" repair	PPS233001	\$2.50	PPS688178	\$105.00
Stop Mount with extended wear spring hole bushing	PPS025624	\$43.00	n/a	n/a
White/Massey Ferguson	Product ID	Prc/Row	Bit Package	Prc/Pack
9000 closing wheel bracket; 1-1/8" repair	PPS840900	\$21.00	PPS688119	\$145.00



## PPS CLOSING WHEEL BRACKET KITS - KINZE 2000, 3000 & JD MAXEMERGE



Kinze	Description	Product ID	Price/Row
2000	Includes: bracket, stop mount, spring, handle, & hardware	PPS820710	\$180.00
3000	Includes: bracket, stop mount, spring, handle, & hardware	PPS820720	\$180.00
John Deere	Description	Product ID	Prc/Row
MaxEmerge (7000/7100)	Includes: bracket, stop mount, spring, handle, & hardware	PPS820700	\$199.00

Brackets will use 5/8" (16mm) bolt-on style closing wheels. MaxEmerge row units and older Kinze 2000 series planters will require a closing wheel with an updated bearing.

# OTHER PPS BUSHING REBUILD KITS



## JOHN DEERE PNEUMATIC DOWN PRESSURE SUPPORT ARM REPAIR KIT

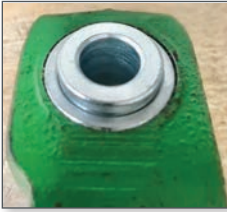

John Deere	Product ID	Price/Row	Bit Package	Price/Pack
Pneumatic down pressure support arm, 1-1/8" bushing repair kit	PPS860881	\$20.40	PPS688222	\$145.00



## CASE-IH BUSHING KIT FOR CLOSING WHEEL ARMS



Slide the PPS sleeve on over the existing worn out pin and weld it on the end only. This new hardened pin can now be used with the PPS bushings that you install in the arms.

Case-IH	Product ID	Price/Row	Bit Package	Price/Pack
800, 900 series closing wheel arm; 1-1/4" repair kit	PPS840119	\$65.00	PPS688114	\$160.00
1200 series closing wheel arm; 1-1/4" repair kit	PPS840114	\$65.00	PPS688114	\$160.00



## PPS FLANGE BUSHING REBUILD KIT FOR ROW CLEANERS



Martin-Till	Product ID	Price/Row	Bit Package	Price/Pack
WA1345, WA1360, C125; 1-1/16" repair kit	PPS841316	\$30.00	PPS688116	\$205.00
Yetter	Product ID	Price/Row	Bit Package	Price/Pack
2967; 1-1/16" repair kit	PPS840416	\$23.00	PPS688049	\$168.00

## REAMER BITS, PPS REPLACEMENT PARTS & ACCESSORIES

Reamer Bits		
Description	Product ID	Price/Ea
11/16"	PPS681116	\$42.00
11/16", Case-IH 1200	PPS601116	\$63.00
3/4"	PPS601134	\$51.00
1-1/16"	PPS680116	\$129.00
1-1/8"	PPS680118	\$135.00
1-3/16"	PPS680316	\$161.00
1-1/4"	PPS680114	\$127.00
1-11/16"	PPS680016	\$233.00

Drill Bits		
Description	Product ID	Price/Ea
7/16"	PPS610716	\$9.95
Step Bit	PPS699102	\$39.00

Other Accessories		
Description	Product ID	Price/Ea
Cutting Fluid, 16 oz	PPS699100	\$12.95
Retaining Compound, 50ml	PPS699101	\$20.95
Vibra Tite, 10 ml	PPS699104	\$7.25

Replacement Parts		
Description	Product ID	Price/Ea
1-1/16" Flange Bushing	PPS100116	\$4.33
1-1/8" Flange Bushing	PPS100118	\$4.33
1-3/16" Flange Bushing	PPS100316	\$4.33
Hex Bushing (JD, Kinze, White)	PPS320078	\$6.93
Hex Bushing (CIH/NH)	PPS310078	\$7.98
5/8" Jam Nut	PPS505818	\$0.40

# FINGER-TILL CLOSING WHEELS

S.I. Distributing's  
**FINGER-TILL**  
**CLOSING WHEELS**

**Finger-Till Cast Closing Wheels crumble sidewalls and close the furrow for optimum seed-to-soil contact.**

- Side fins provide depth control and fine-tune the soil.
- Better in wet, no-till conditions



**More Aggressive!**

"These soybeans were planted on May 25th. This picture was taken on May 29th. Soybean on the left was planted with the S.I. Distributing Finger-Till Closing Wheel. It is already out of the ground, while the other one isn't."



- M.H. Farmington, PA



**PFR PROVEN**

**"PFR Proven" Status:** If a product has been tested in Beck's Practical Farm Research and found to provide annual yield gains and averages a positive ROI over a minimum of three years, that product earns the status of "PFR Proven."

- More aggressive
- Better in wet, no-till conditions
- Reduces sidewall compaction
- 15" in diameter
- Lightly tills the soil



Recommended Distance Between Points: 2-1/2"

**"Try a row"**

**Purchase Finger-Till closing wheels for a single row\* to see how it performs in your fields.**

Finger-Till Cast Closing Wheels			
Description	Make/Model	Product ID	Price
5/8"/16mm Wheels attach with bolt and nut.	<b>John Deere</b> - ME Plus, XP, ME5, EE <b>Kinze</b> - '93 and later <b>White</b> - 6000, 8000, 9000 <b>Monosem</b> - late plus <b>Great Plains</b> - with bolt on wheels	PLT110063	\$128.00
17mm Wheels slide on threaded stud and held on with nut.	<b>John Deere</b> - MaxEmerge 2	PLT110070	\$128.00
Roll pin (water pump style); Wheels attach with roll pin through bearing stem.	<b>John Deere</b> - MaxEmerge <b>Kinze</b> - pre '93 <b>Monosem</b> - early plus	PLT110081	\$128.00
Older planters with upgraded closing wheel brackets will typically use 5/8"/16mm bolt on wheels (PLT110063).			
*It is recommended to run two Finger-Till Closing Wheels per row.			
Finger-Till Closing Wheels weigh 15.75 lbs each.			

# ROLLER BEARING GAUGE WHEEL ARM KITS

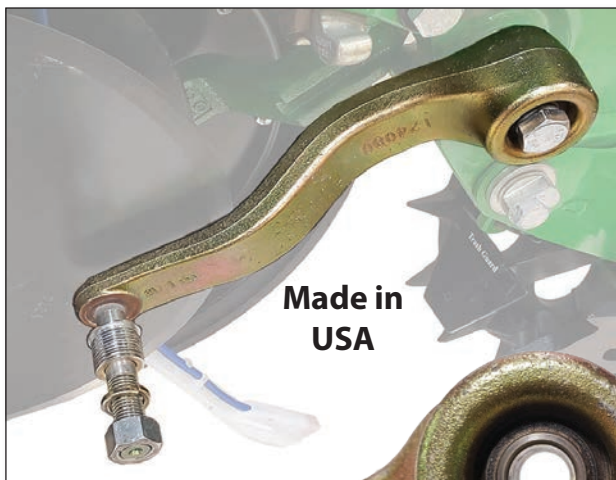

Made in USA

5203KYY2 sealed double-roller bearing



Cast replacement arms, from Norseman, feature the industry standard 5203KYY2 sealed bearing. This double-roller bearing **stays tight and withstands the abuse**, unlike the OEM threaded bushings.

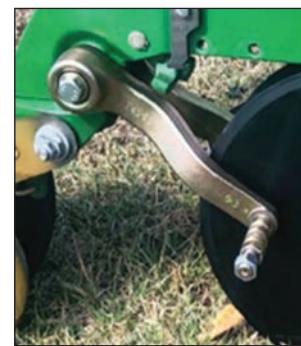

***"Try a row" ... purchase a Norseman Roller Bearing Gauge Wheel Arm Kit (includes two arms) for a single row to see how it performs in your fields.***



NMI136000

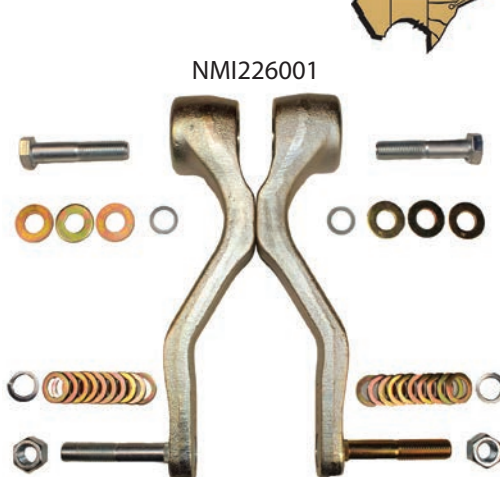

NMI226001



## Australian-Quality Reputation - Made in USA

Since 1980, Norseman is a family owned and operated company in Australia, with a reputation of manufacturing high-quality, longer-lasting planter replacement parts. The Norseman gauge wheel arms, that are distributed by S.I. Distributing, are made in the USA, with the same standard of excellence.

Norseman Gauge Wheel Arm Kit			
Make	Model	Product ID	Price/Row
John Deere	XP, XP Pro, MaxEmerge 5, ExactEmerge	NMI226001	\$159.00
Kinze	3000, 4000 series	NMI136000	\$189.00

## NORSEMAN SCRAPER RINGS

**Clean opener blades produce a well-defined seed trench.**

- Its conical profile keeps the scraper ring securely mounted and maintains optimal angle of attack to clean mud from disc opener blades.
- Use in conjunction with the Norseman roller bearing gauge wheel arms to dramatically reduce maintenance intervals.
- Unique mounting method allows flex to avoid mud build-up.
- Prevent premature tire wear.

**NOTE: For new tires and/or assemblies only.**

Norseman Conical Scraper Rings		
Description	Product ID	Price/Each
Scraper Ring	NMI131000	\$38.00
<b>NOTE: For new tires and/or assemblies only.</b>		

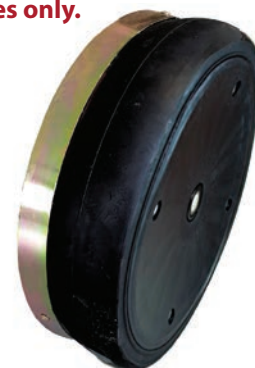

# YETTER TWISTER CLOSING WHEEL

**TWISTER**



YTR6200005

Yetter Twister Closing Wheels have a twisted-spike design that breaks up sidewall compaction and is effective in a wide range of soil conditions. Whatever your tillage practice or soil type, Twister Closing Wheels seal the seed trench, ensuring seed-to-soil contact for optimal seed germination and uniform emergence.

**Since its introduction, the Twister Closing Wheel has received positive feedback.**

In Beck's Practical Farm Research studies, the Twister increased yields by an average of **6.4 bushels per acre**. (Please remember yield results vary based on many factors each year.)



YTR6200006



YTR6200009

## THE TWISTER DIFFERENCE

**Crumbles and firms soil simultaneously:** Twisted spikes enhance seed-to-soil contact and help create the ideal seed environment, leading to even crop emergence and higher yields. The rounded center ring—sized 12" to match the size of rubber closing wheels—maintains consistent depth.

**Works in diverse field conditions, cover crops, and tillage practices:** Optimize performance for minimum-till, conventional, strip-till, vertical tillage, or no-till by adjusting down pressure on the tail wheel closing arm.

**Fractures the sidewall:** In wet, unfavorable planting conditions, the Twister fractures the sidewall. This reduces the potential for crusting and the seed trench drying out and cracking open.

Yetter Twister Closing Wheel Set	Vendor ID	Product ID	Price/Row
5/8" bearing or 16mm bolt on - poly	6200-005	YTR6200005	\$230.00
5/8" bearing or 16mm bolt on - cast	6200-009	YTR6200009	\$275.00
Yetter Twister Closing Wheel Inserts	Vendor ID	Product ID	Price/Row
Insert, LH & RH	6200-006	YTR6200006	\$140.00
Cast Insert, LH & RH	6200-036	YTR6200036	\$150.00



YTR6200051

Interchanger Kit for Bolt-On Closing Wheels		
Description	Product ID	Price/Row
Kinze, White 6000, 8000 series	YTR6200050	\$45.00
John Deere 1700 series	YTR6200051	\$45.00

# COPPERHEAD AG FURROW CRUISER



The Copperhead Furrow Cruiser® has solved the SIDE-WALL COMPACTION problem that came with the development of the double disk opening system on modern planters. The Furrow Cruiser uses a spike to crumble down the compaction in the sidewall and then having width at the base of the spike to firm the soil around the seed. This leads to the best seed depth and most even seed emergence possible.



CPH924016

CPH913016

CPH913015

CPH913014

## Copperhead Furrow Cruiser Closing Wheels

Description	Vendor ID	Product ID	Price/Row	
Furrow Cruiser Inserts	Standard Depth, poly	JWK-16	CPH924016	\$140.00
	Shallow Depth, poly	JWK-16 SD	CPH984016	\$140.00
Furrow Cruiser Complete (Compatible with inserts)	Standard Depth, 5/8" or 16mm bolt on, poly	JWK-16C	CPH913016	\$240.00
	Shallow Depth, 5/8" or 16mm bolt on, poly	JWK-16C SD	CPH983016	\$240.00
Furrow Cruiser II	5/8" or 16mm bolt on, poly	FC II-15	CPH913015	\$195.00
Cruiser Xtreme	5/8" or 16mm bolt on, cast	FX-14	CPH913014	\$299.00
Drill Cruiser	John Deere 60/90 Series & 540C Seeders & Drills, cast	CA-1122	CPH901122	\$130.00
SFP Cruiser	John Deere Separate Fertilizer Placement Units, cast	SFP-13	CPH908813	\$159.00

# A1 WEEDER

## Weed Control the New and Improved Way!

- Ideal for many crops such as pumpkins, zucchinis, strawberries, cabbages, cauliflowers, cucumbers, raspberries, hemp, watermelon, cantelope, tomatoes, etc.
- Adjusts for up to 3' tall crop height
- Reduces hand weeding, saving time and labor costs
- Targets in-row and between-row weeds with minimal soil disturbance



A-1 Implements

6" heads shown in this picture with three tines, also available with 10" heads with 4 tines each.



### A1 1-ROW WEEDER

- Single row
- Three point mount with 3x3 toolbar
- Two hydraulic driven heads
- Available with two 6" heads with 3 tines or two 10" heads with 4 tines
- For 30" minimum row spacing



Designed for complete weed removal, the weeder pulls out the entire root system to ensure weeds don't return.

The 1-Row Weeder with parallel arms floats over uneven terrain for consistent ground engagement and smooth operation. It has improved visibility over the Original Mini-Weeder, with an elevated seat for better sightlines during operation.

#### A1 1-Row Weeder with Parallel Linkage

Product ID	Description	Price
AOW000601	A1 Mini Weeder, 6" Heads, No Sweeps	\$7,995.00
AOW001001	A1 Mini Weeder, 10" Heads, No Sweeps	\$7,995.00

## CUSTOM A1 WEEDERS

- Available in 1 through 8 row models
- 1-row and 3-row models are adjustable from 30" to 72"
- 2-row and 4-row models are adjustable from 30" to 48"
- Adjusts for up to 42" crop height
- Adjustable toolbar design
- Hand hydraulic lift or foot pedal lift models available
- Available with PTO pump hookup for hydraulics or remote hookups (Machines use from 2-4 remotes, depending on size)



For more information regarding custom A1 Weeders, please call toll-free 800-368-7773.

# KEETON SEED FIRMERS

Keeton Seed Firmers firm the seed to the bottom of the furrow and improve seed-to-soil contact.

*Proven average of 6-bushel increase in corn yield, due to better stands because:*

- Pushes the seed to the bottom of the seed trench
- Hits depth set on your planter
- Ensures uniform seed-to-soil contact, uniform seed germination and uniform emergence

## Seed-to-Soil Contact Made Easy

Seeds don't always land in the bottom of the trench where they belong.

This can leave an air pocket underneath them, not allowing them to take up moisture as fast as they could. That leads to late germination and emergence, and finally, loss of yield. The Keeton Seed Firmer firms the seed to the bottom of the furrow and improves seed-to-soil contact. Uneven seed germination and uneven plant emergence affects yields. Plants coming up even a little late can't compete with their neighbors for resources and they're vulnerable to heat stress and insects.

**Firmer contact leads to uniform emergence leads to 1,000 more ears per acre or 6 bushels per acre.**

Keeton Seed Firmers set the seed at the right depth and create consistent seed-to-soil contact. That leads to uniform germination and uniform emergence. Studies have shown that leads to an average increase of 1,000 more ears of corn or six bushels per acre in corn yield.



# KEETON SEED FIRMERS



## Apply In-furrow Liquid



The Keeton seed firmer can also act as a liquid application tool for insecticides, fungicides, and proper in-furrow fertilizers. Get the benefits of firming, as well as liquid application in a single device.

### Determine the Effectiveness of Your Keeton Seed Firmer

To optimize the performance of the Keeton Seed Firmer, it is important to verify tension. Using a small hanging scale or a fish scale to measure tension, **1.25 lbs of tension is ideal.**

For complete information on how to measure the tension, as well as how to ensure that the Keeton Seed Firmer is set up to perform to its potential, please go to

[www.sidist.com/Keeton-Seed-Firmer-Preparation-for-Planting.pdf](http://www.sidist.com/Keeton-Seed-Firmer-Preparation-for-Planting.pdf)

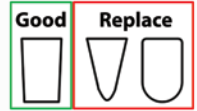

## KEETON SEED FIRMERS - QUICK ATTACH

### Quick Attach tails are fast and easy to replace

- Design allows the tail to be snapped into place and be changed without removing seed openers or gauge wheels.
- Improved bracket design; contains more metal than Universal brackets.
- Replacement tails are more affordable than Universal replacement tails.



Keeton Seed Firmer - Quick Attach					
John Deere	Type	Description	Firmer Options	Product ID	Price
7000, 7100, 7200, 7300, 1700, 1705, DB Planters 1530, 1535 Drills	Quick Attach	Mounts to seed disc opener shafts and lower seed tube pin. Will fit all MaxEmerge row units including ME5. <b>Will NOT fit ExactEmerge row units.</b>	QA, low profile, single tube	KTN109044	\$40.00
			QA, standard, single tube	KTN109045	\$40.00
			QA, low stick, single tube	KTN109100	\$78.00
1705/DB ExactEmerge	Quick Attach	Will move the closing system 5.4 inches rearward. <b>Will ONLY fit ExactEmerge row units.</b>	QA, low profile, single tube	KTN180044	\$90.00
			QA, standard, single tube	KTN180045	\$90.00
			QA, low stick, single tube	KTN180100	\$128.00
Kinze	Type	Description	Firmer Options	Product ID	Price
2000	Quick Attach	Mounts to seed disc opener shafts and lower seed tube pin.	QA, low profile, single tube	KTN109044	\$40.00
			QA, standard, single tube	KTN109045	\$40.00
			QA, low stick, single tube	KTN109100	\$78.00
3000	Quick Attach	Mounts to seed disc opener bolts and lower seed tube pin. <b>Will NOT work with large OEM seed tubes.</b> Will work with Precision Planting seed tubes	QA, low profile, single tube	KTN120044	\$40.00
			QA, standard, single tube	KTN120045	\$40.00
			QA, low stick, single tube	KTN120100	\$78.00
4000, 5000	Quick Attach	Mounts to seed disc opener bolts and lower seed tube pin. <b>Will NOT work with large OEM seed tubes.</b> Will work with Precision Planting seed tubes.	QA, low profile, single tube	KTN150044	\$40.00
			QA, standard, single tube	KTN150045	\$40.00
			QA, low stick, single tube	KTN150100	\$78.00
2000, 3000, 4000, 5000	Quick Attach	Mounts inside row unit between scrapers. Will work with large OEM seed tubes. <b>Will NOT work with spring loaded disk scrapers, must convert to bolt on style scrapers. 5000 series planters require holes to be drilled out to 3/8".</b>	QA, low profile, single tube	KTN130044	\$56.00
			QA, standard, single tube	KTN130045	\$56.00
			QA, low stick, single tube	KTN130100	\$94.00
White	Type	Description	Firmer Options	Product ID	Price
8000	Quick Attach	Mounts to bracket behind seed tube	QA, low profile, single tube	KTN135044	\$55.00
			QA, standard, single tube	KTN135045	\$55.00
			QA, low stick, single tube	KTN135100	\$93.00
9000	Quick Attach	Mounts to seed disc opener bolts and lower seed tube pin	QA, low profile, single tube	KTN111044	\$40.00
			QA, standard, single tube	KTN111045	\$40.00
			QA, low stick, single tube	KTN111100	\$78.00

# KEETON SEED FIRMERS

## KEETON SEED FIRMERS - UNIVERSAL BRACKET

- . Bracket mounts to seed disk opener shafts and around row unit shank.
- . Has an adjustable tension screw.
- . Available with dual liquid tube tail, dry tail or low profile tail.
- . Not for use with Precision Planting SpeedTube®.
- . Mounts inside row unit between scrapers.

### Universal Bracket Mount



## KEETON SEED FIRMERS - KINZE BRACKET

- . Mounts inside row unit between scrapers.
- . Has an adjustable tension screw.
- . Will not work with rotary disk scrapers.
- . Available with dual liquid tube tail, dry tail or low profile tail.
- . Not for use with Precision Planting SpeedTube®.

### Kinze Bracket Mount



Keeton Seed Firmers - Universal Bracket & Kinze Bracket					
Model	Type	Description	Firmer Options	Product ID	Price
<b>John Deere</b>					
7000, 7100, 7200, 7300, 1700, 1530 Drill, 1535 Drill	Universal Bracket	Bracket mounts to seed disk opener shafts and around row unit shank Will fit MaxEmerge, ME2, ME Plus, ME Pro, ME XP Will NOT fit MaxEmerge 5 or ExactEmerge row units	Standard dry	KTN125012	\$34.00
			Standard dual liquid tube	KTN115011	\$34.00
			Short low profile tail, single liquid tube	KTN126008	\$34.00
<b>Kinze</b>					
2000, 3000	Kinze Bracket	Mounts inside row unit between scrapers Will NOT work with spring loaded disk scrapers	Standard dry	KTN125014	\$34.00
			Standard dual liquid tube	KTN115014	\$34.00
			Short low profile tail, single liquid tail	KTN126011	\$34.00
<b>White</b>					
6000, 8000, 9000	Universal Bracket	Bracket mounts to seed disk opener bolts Bracket modification is required	Standard dry	KTN125012	\$34.00
			Standard dual liquid tube	KTN115011	\$34.00
			Short low profile tail, single liquid tube	KTN126008	\$34.00

## KEETON PLANTER REPLACEMENT TAILS

Keeton Planter Replacement Tails											
All are compatible with WaveVision seed tubes.											
Standard Dry Tail		Standard Liquid Tail		Short Low Profile Tail		Quick Attach Standard Tail		Quick Attach Low-Profile Tail		Quick Attach Low Stick Tail	
<b>For Universal and Kinze Mounting Brackets</b>						<b>For Quick Attach Mounting Brackets</b>					
Standard replacement tail with no liquid application tube. Recommended in non-sticky soil types and all planting environments.		Standard replacement tail with two liquid application tubes. Recommended in non-sticky soil types and all planting environments.		Low profile replacement tail with one liquid application tube. Recommended in sticky soil types and no-till or minimum-till planting environments. Not recommended in sandy soil types.		Standard replacement tail with one liquid application tube. Recommended in non-sticky soil types and all planting environments.		Low profile replacement tail with one liquid application tube. Recommended in sticky soil types and no-till or minimum-till planting environments. Not recommended in sandy soil types.		Low stick replacement tail with one liquid application tube. Recommended in sticky soil types and no-till or minimum-till planting. Not recommended in sandy soil types.	
Product ID	Price	Product ID	Price	Product ID	Price	Product ID	Price	Product ID	Price	Product ID	Price
KTN125011	\$29.00	KTN115013	\$29.00	KTN126010	\$29.00	KTN140045	\$20.00	KTN140044	\$20.00	KTN140100	\$58.00

# KEETON SEED FIRMERS

## Seed Tube Mount



## KEETON SEED FIRMERS - SEED TUBE MOUNT

- Mounts directly to the seed tube.
- Available with dry tail or liquid tail.
- Has an adjustable tension screw.

Keeton Seed Firmers - Seed Tube Mount					
Model	Type	Description	Firmer Options	Product ID	Price
<b>Great Plains</b>					
Yield-Pro	Seed Tube Mount	Mounts to seed tube	Standard dry	KTN101000	\$31.50
			Standard single liquid tube	KTN101001	\$32.50
<b>John Deere</b>					
7000, 7100, 7200, 7300, 1700, 1530 Drill, 1535 Drill	Seed Tube Mount	Mounts to seed tube will NOT fit ExactEmerge row units	Standard dry	KTN101000	\$31.50
			Standard single liquid tube	KTN101001	\$32.50
<b>Kinze</b>					
2000, 3000	Seed Tube Mount	Mounts to seed tube. Will NOT fit EdgeVac, Will NOT fit large OEM seed tube	Standard dry	KTN101000	\$31.50
			Standard single liquid tube	KTN101001	\$32.50
<b>Monosem</b>					
All	Seed Tube Mount	Mounts to seed tube	Standard dry	KTN101000	\$31.50
			Standard single liquid tube	KTN101001	\$32.50
<b>White</b>					
5000, 6000, 8000, 9000	Seed Tube Mount	Mounts to seed tube	Standard dry	KTN101000	\$31.50
			Standard single liquid tube	KTN101001	\$32.50

Keeton Brackets			
Description	Product ID	Price	
<b>John Deere</b>			
Bracket, Quick Attach, John Deere Exact Emerge	KTN141180	\$70.00	
Bracket, Quick Attach, John Deere ME, ME2, ME+, Pro, XP, ME5	KTN150109	\$20.00	
Bracket, Universal, John Deere ME, ME2, ME+, Pro, XP	KTN131500	\$10.50	
<b>Kinze</b>			
Bracket, Quick Attach, Kinze 3000. Will NOT work with large OEM seed tubes. Mounts around seed tube, fastens to seed opener bolts.	KTN150120	\$20.00	
Bracket, Quick Attach, Kinze 2000, 3000, 4000, 5000. Will work with large OEM seed tubes. Mounts behind seed tube, fastens to disc scraper bolts 5000 series requires drilling mounting bracket holes to 3/8".	KTN150130	\$36.00	
Bracket, Quick Attach, Kinze 4000, 5000. Will NOT work with large OEM seed tubes. Mounts around seed tube, fastens to seed opener bolts.	KTN150150	\$20.00	
Bracket, Kinze, 2000, 3000	KTN111505	\$20.00	
<b>White</b>			
Bracket, Quick Attach, White 8000	KTN150135	\$35.00	
Bracket, Quick Attach, White 9000	KTN150111	\$20.00	
Bracket, Universal, White 6000, 8000, 9000	KTN131500	\$10.50	

Keeton Replacement Parts		
Nozzle Kit, includes 1 splitter nozzle and 1 single stream nozzle, Quick Attach & Low Stick	KTN140105	\$6.00
Package of 4, splitter and insert, Quick Attach	KTN140049	\$15.00
Splitter insert, Universal, Kinze	KTN900004	\$0.55
Tubing, blue, 1/4" diameter, per foot	KTN900000	\$0.25
Tubing, red, 1/4" diameter, per foot	KTN900024	\$0.25



KTN150109



KTN141180



KTN131500



KTN111505

# KEETON SEED FIRMERS

Get the money-making advantages of Keeton Seed Firmers for your drill too.

- Reduced seed costs. Improved germination means you get better stands with fewer seeds. On average, tests show a 9.4% increase in soybean germination.
- Field tests show an average soybean field yield increase of over 7%.

Drill firmers are only available with liquid tails.

**DRILLS**



## Keeton Seed Firmer Drill Application Guide

Models	Notes	Bracket and Tail	Price	Replacement Tail Only	Price
<b>Case-IH</b>					
5100, 5400	Mounts to scraper housing.	KTN210006	\$29.50	KTN210054	\$27.50
<b>Crustbuster</b>					
3700, 3800 3400 w/o parallel arms	Mounts on scraper bracket. Will not fit 3400 All-Plant or 3400 Min-Till openers.	KTN210002	\$30.50	KTN210054	\$27.50
3400, 4000	Mounts to scraper support rod. Fits All-Plant & Min-Till openers.	KTN210004	\$30.50	KTN210054	\$27.50
<b>Great Plains</b>					
Fluted Metering Wheel Drills: 00, 05, 06, 07, 10 Series; 20 Series (-2003)	Mounts to scraper bracket.	KTN210008	\$29.50	KTN210054	\$27.50
Precision Drills (singulating & volumetric metering wheel): 10, 20 Series	Mounts to scraper bracket.	KTN210010	\$29.50	KTN210055	\$27.50
15, 25 Series Planter Style Row Units and HD10 Series Row Units	Mounts to scraper bracket.	KTN210027	\$29.50	KTN210055	\$27.50
All 00HD Series Row Units	Mounts to scraper bracket.	KTN210028	\$29.50	KTN210055	\$27.50
<b>John Deere</b>					
1560, 1860, 1590, 1890, 1690, 1990	Mounts to back of t-handle slotted bracket.	KTN210012	\$50.00	KTN210054	\$27.50
450, 455, 1520	Mounts to seed disk scraper.	KTN210014	\$29.50	KTN210054	\$27.50
750, 1850	Mounts to seed disk scraper.	KTN210016	\$65.00	KTN210054	\$27.50
<b>Krause</b>					
Most	Mounts to fertilizer opener.; Will not fit 5200 and 5400.	KTN210018	\$30.50	KTN210054	\$27.50
<b>Marliss</b>					
Most	Mounts to seed disk opener. Will not fit 2038.	KTN210020	\$30.50	KTN210054	\$27.50
<b>Sunflower</b>					
9411, 9412, 9421	Mounts to back of disk opener casting.	KTN210024	\$30.50	KTN210025	\$30.50
<b>Tye</b>					
All	Mounts to seed disk scraper.	KTN210023	\$30.50	KTN210054	\$27.50

# MUR-LOK FITTINGS

- Leak Resistant Dual EPDM O-Rings
- Chemical Resistant Polypropylene
- NSF Standard 58 Certified
- 150 psi @ 70°F
- 60 psi @ 140°F
- For Use with Plastic or Soft Metal Tubing

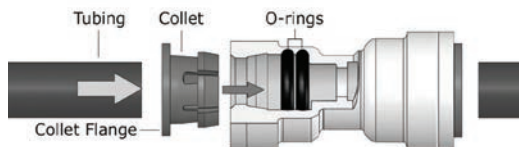

Mur-Lok Fittings		
Description	Product ID	Price
Mur-Lok union, 1/4" to 1/4"	KTN500000	\$2.44
Mur-Lok union, 3/8" to 1/4"	KTN500001	\$3.34
Mur-Lok union, 3/8" to 3/8"	KTN500002	\$3.32
Mur-Lok union, 1/2" to 3/8"	KTN500003	\$4.49
Mur-Lok union, 1/2" to 1/2"	KTN500004	\$3.80
Mur-Lok union, 5/16" to 1/4"	KTN500005	\$2.69
Mur-Lok union, 5/16" to 5/16"	KTN500006	\$2.60
Mur-Lok divider, 1/4" to 1/4"	KTN500100	\$3.84
Mur-Lok divider, 3/8" to 3/8"	KTN500101	\$4.45



## Improve the performance of your Keeton Seed Firmers in wet soil conditions with the Exapta Mojo Wire's self-cleaning action of the Keeton against the furrow sidewalls.

The Exapta Mojo Wire stiffener supplies up to 3 times the pressure to the standard Keeton. In testing and customers' experience, there has been a much better germination consistency – both in terms of higher percentages of seeds emerging, and in uniformity of timing of emergence.



### Why the Mojo Wire?

- Up to 3x pressure of standard Keeton
- Ensures fast, uniform germination
- Large payback potential, especially in resilient no-till soils
- Quick fix for limp, aging Keeton firmers



KTN400315

Mojo Wire Kits		
Description	Product ID	Price
Mojo Wire, for Quick Attach mount, dry & liquid tails	KTN400315	\$19.00
Mojo Wire, for Universal bracket mount, liquid tails only	KTN400211	\$20.00
Mojo Wire, for Universal bracket mount, dry tails only	KTN400212	\$11.50
Mojo Wire, for Keeton seed tube mount	KTN400100	\$23.00
Mojo Wire, for Keeton drill firmer	KTN400600	\$11.00
Mojo Wire, for CNH Keeton drill firmer	KTN400608	\$13.00

## DRILL FIRMERS WITH MOJO WIRE KITS

Models	Notes	Firmer Option	Bracket & Tail	Price	Tail Only	Price
<b>Case-IH/New Holland</b>						
CIH P-500 NH 2080, 2085	Mounts to opener on RIGHT side of drill. Only works with Exapta closing wheel upgrade kit.	Standard liquid tail w/o mojo wire	KTN210060	\$68.55	KTN210056	\$45.80
CIH P-500 NH 2080, 2085	Mounts to opener on LEFT side of drill. Only works with Exapta closing wheel upgrade kit.	Standard liquid tail w/o mojo wire	KTN210061	\$68.55	KTN210056	\$45.80
CIH P-500 NH 2080, 2085	Mounts to opener on RIGHT side of drill. Only works with Exapta closing wheel upgrade kit.	Standard liquid tail w/ mojo wire	KTN210064	\$68.55	KTN210156	\$45.80
CIH P-500 NH 2080, 2085	Mounts to opener on LEFT side of drill. Only works with Exapta closing wheel upgrade kit.	Standard liquid tail w/ mojo wire	KTN210065	\$68.55	KTN210156	\$45.80
CIH P-500 NH 2080, 2085	Mounts to opener on RIGHT side of drill. Works with OEM packer wheel.	Dry tail w/ mojo wire	KTN210062	\$68.55	KTN210159	\$45.80
CIH P-500 NH 2080, 2085	Mounts to opener on LEFT side of drill. Works with OEM packer wheel.	Dry tail w/ mojo wire	KTN210063	\$68.55	KTN210159	\$45.80

# SEED & MECHANICAL LUBRICANTS



## DUST Improves Seed Flow!

**DUST Soy-Protein Lubricant provides top-end singulation and is less abrasive to seeds than dirty talc and graphite. DUST is cleaner, safer, non-carcinogenic, and made from U.S. Soybeans.**

### This is your Soy Check-Off Dollars at work!

This innovative, microplastic-free lubricant provides the needed lubricity for proper seed flow for any seed. DUST is proven to reduce static and to be up to 20 times less abrasive to seed than Talc (SGS Labs Study).

Talc and graphite are designed to lubricate seeds and planter equipment. DUST does the same thing but is safer for the farmer and the seed.

### DUST is created from U.S. - sourced soybeans.

It takes one bushel of soybeans to make 11 lbs. of DUST. Since it is made from soy protein, it will break down within 28 days from the furrow and provide more green-up and early plant viability.



LMT531914



LMT501901

## Cleaner. Safer. Soy.® Solution

**CLEANER:** no more having to clean your hands, face or clothing from talc / graphite grime.



### Graphite/Talc (left) vs. DUST

DUST is a low-use rate product. Generally, the starting rate should be no greater than one-half to one ounce per unit of seed.

### PLEASE COMPARE COST PER UNIT.

To calculate how many pounds of DUST you need, please visit the DUST page on [www.sidist.com](http://www.sidist.com)

One pound of DUST treats an average of 32 to 50 units of seed.

### DUST Soy Protein Lubricant

Description	Product ID	Price
Dust, 1-lb container	LMT501901	\$16.50
Dust, 14-lb container	LMT531914	\$130.00

## eFLOW 80% TALC & 20% GRAPHITE MIX

This special blend of talc and graphite improves seed loading and seed release – and that improves seed spacing. eFlow improves the flow of seed from the hopper to the meter. In the meter, eFlow ensures that seeds release consistently once the vac is shut off and seeds drop to the seed tube. The addition of graphite, especially in smaller seeds, helps seeds slide off the disk like clockwork.



PPM930004



PPM930006

Graphite, eFlow and Dispenser Lid			
Description	Product ID	Price	
Graphite, 1-lb. bottle	BMP001775	\$5.95	
Graphite, 5-lb. jug	PPM930015	\$18.95	
Eflow, 80% talc, 20% graphite, 8-lb. container	PPM930004	\$35.75	
Dispenser lid, works with 8-lb. jugs of Precision Planting eFlow & talc; CNH 8-lb. talc/graphite & graphite; EZ Slide 8-lb. talc; Rural King 8-lb. talc/graphite. Does NOT fit John Deere containers.	PPM930006	\$12.95	



BMP001775



PPM930015

# SEEDRIGHT SEED PLATES

## SeedRight Large Cell Discs

Accurately plant small grains including wheat, oats, triticale, cereal rye, and cover crop mixes based in cereal rye. For larger sized seeds, commonly less than 35,000 seeds per pound.

## SeedRight Small Cell Discs

Accurately plant cover crops including radishes, turnips, crimson clover, rape seed and rye grasses. For smaller sized seeds, commonly greater than 35,000 seeds per pound.

SeedRight Large Cell Vacuum Meter Disc			
Wheat, Oats, Cereal Rye, Triticale			
9K-35K Seeds Per Pound			
Description	Product ID	Vendor ID	Price
John Deere - Vacuum Meter	SRP230090	PLJD-AA0030L	\$46.00
Kinze - EdgeVac	SRP460061	PLKZ-AA0060L	\$46.00
Precision Planting - vSet	SRP612110	PLPP-AA0012L	\$39.00

SeedRight Small Cell Vacuum Meter Disc			
Radish, Turnips, Crimson Clover, Rye Grasses, Rapeseed			
35K-300K Seeds Per Pound			
Description	Product ID	Vendor ID	Price
John Deere - Vacuum Meter	SRP236050	PLJD-AA0036S	\$46.00
Kinze - EdgeVac	SRP460062	PLKZ-AA0060S	\$46.00



John Deere  
Large Cell Disc

John Deere  
Small Cell Disc

Kinze EdgeVac  
Large Cell Disc

Kinze EdgeVac  
Small Cell Disc

Precision Planting  
Large Cell Disc

\*Rate Charts are available upon request, or by visiting our website at [www.sidist.com/cover-crop-seed-plates.htm](http://www.sidist.com/cover-crop-seed-plates.htm)\*

## KINZE BRUSH METERS - BACKER PLATE

These backer plates are for use with Kinze Brush Type mechanical meters. The backer plate works together with the OEM plates to enable the Brush Type meter to accurately plant small grains and cover crops. It helps to create a seal around the edge of your plate to avoid small seed leaking out.

- OEM 48 Cell Large Bean Disc: Wheat, Cereal Rye, Oats
- OEM 60 Cell Milo Disc: Radish, Crimson Clover, Turnips, Alfalfa
- OEM 30 Cell Milo Disc: Radish, Crimson Clover, Turnips, Alfalfa



Kinze Brush Meter  
Backer Plate (inside)  
#SRP400011

NOTE: These backer plates are attached with two existing wing nuts.

SeedRight Kinze Brush Meter Backer Plate			
Description	Product ID	Vendor ID	Price
Backer Plate, Kinze Brush Meter	SRP400011	PLKZ-AA0001A	\$37.00

Backer Plate/Seed Disc Combo Pack		
Description	Product ID	Price
Backer Plate & Soybean 48 Cell Disc	SRP410048	\$60.95
Backer Plate & Milo 60 Cell Disc	SRP410060	\$60.95
Backer Plate & Milo 30 Cell Disc	SRP410030	\$60.95



# ACCR ROW CLEANERS

## COMPACT CLEAN RIDE™ (ACCR) ROW CLEANER

**Improves planter performance with innovative cast parallel linkage design.**

The **ACCR1360 floating row cleaner** measures less than 14" from the face plate. It uses the HA44270D heavy-duty greaseable tapered roller bearing hub with a triple-lip seal.



**ACCR1360**  
Row Cleaner

The **ACCR1345 floating row cleaner** is perfect for **high speed or narrow rows**. It measures less than 16" from the face plate. It uses CHU44C cast hubs and maintenance-free, long-life 5205 double row bearing with a six-lip seal.

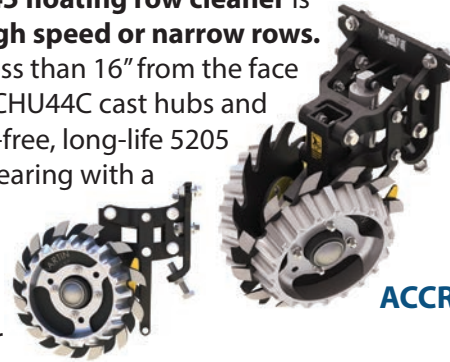

**ACCR1345**  
Row Cleaner

**ACCR1345**

**Treader Wheels are sold separately.**

- 4" vertical travel
- Parallel linkage allows for easy floating action, especially when paired with Martin-Till® SmartClean or Precision Planting Clean Sweep®
- Compatible with front frame mounted nitrogen coulters or where full-size row cleaners can't be used due to clearance issues
- Factory pre-assembled chassis saves time and makes it a cinch to install
- Choice of Spike or Razor wheels can be installed, intersected or offset

**Please see spike wheel and razor wheel comparison on page 23.**



**#MRT801252**  
13" Depth Blade  
(Filler Plate)



**#MRT900409** CIH 2000  
Series Adapter Bracket

### ACCR1360 Wide Floating Row Cleaner Compact Clean Ride

Case-IH	Vendor ID	Spiked	Razor	Price
800, 900, 1200	ACCR1360-1200	MRT141360	MRT241360	\$849.50
2000 (1)	ACCR1360	MRT101360	MRT201360	\$789.50
Fendt	Vendor ID	Spiked	Razor	Price
Momentum	ACCR1360	MRT101360	MRT201360	\$789.50
John Deere	Vendor ID	Spiked	Razor	Price
7000, 7100, 7200, 7300, 1700, DB	ACCR1360	MRT101360	MRT201360	\$789.50
Kinze	Vendor ID	Spiked	Razor	Price
2000, 3000, 4000, 5000	ACCR1360	MRT101360	MRT201360	\$789.50
White, Massey Ferguson	Vendor ID	Spiked	Razor	Price
6000, 8000, 9000	ACCR1360	MRT101360	MRT201360	\$789.50

It is recommended to run a Clean Sweep system or a Smart Clean Air System with ACCR Row Cleaners.

### ACCR1345 Narrow Floating Row Cleaner Compact Clean Ride

Case-IH	Vendor ID	Spiked	Razor	Price
800, 900, 1200	ACCR1345-1200	MRT141345	MRT241345	\$849.50
2000 (1)	ACCR1345	MRT101345	MRT201345	\$789.50
Fendt	Vendor ID	Spiked	Razor	Price
Momentum	ACCR1360	MRT101360	MRT201360	\$789.50
John Deere	Vendor ID	Spiked	Razor	Price
7000, 7100, 7200, 7300, 1700, DB	ACCR1345	MRT101345	MRT201345	\$789.50
Kinze	Vendor ID	Spiked	Razor	Price
2000, 3000, 4000, 5000	ACCR1345	MRT101345	MRT201345	\$789.50
White, Massey Ferguson	Vendor ID	Spiked	Razor	Price
6000, 8000, 9000	ACCR1345	MRT101345	MRT201345	\$789.50

It is recommended to run a Clean Sweep system or a Smart Clean Air System with ACCR Row Cleaners.

ACCR1360/ACCR1345 Optional Accessories	Vendor ID	Product ID	Price
Aluminum Side Treader Wheel (2 required per row); Reduces trenching in soft soils and provides traction in loosely-worked ground.	STW-04A	MRT003003	\$50.00
Depth blade/filler plate (2 per row) for 13" spiked wheels - eliminates wrapping when planting in to cover crops	BLD10.5	MRT801252	\$40.00
(1) CIH 2000 series adapter bracket (needed if planter is NOT equipped with CIH#4854385)	900409	MRT900409	\$38.00

# KRONOS ROW CLEANERS



**Built for durability and precision, Kronos delivers the performance you need for a clean, consistent seedbed.**

The **Kronos row cleaner** features a more balanced frame, **improves flotation** in looser soils compared to other models. Designed to handle heavy residue, it can be locked in position in 3/8" increments or paired with Smart Clean or CleanSweep® using built-in brackets for easy adjustment.



## BA1350 Row Cleaner

**Compact 15" Length** – Fits behind frame-mounted openers while delivering top performance, ensuring seamless integration with most planter setups.

**50-Degree Angle** – Works with all planter row widths for efficient residue clearing, improving seed-to-soil contact for better germination.

**Adjustable Positioning** – No tools needed, allowing for quick and easy field adjustments.

**Float Mode** – Set lower limits in 3/8" increments and use Smart Clean™ or CleanSweep® for precise pressure control, optimizing performance in different soil conditions.

**Rigid Mode** – Lock at fixed depths in 3/8" increments.

**Heavy-Duty Bearings & Construction** – Features maintenance free Martin Duty C-Hub with 52 mm double-row bearings and multi-lip seals, providing durability and long-lasting performance in tough field environments.

**Treader Wheels are sold separately.**



### Kronos BA1350 Floating Row Cleaner

Case-IH	Vendor ID	Spiked	Razor	Price
800, 900, 1200	BA1350	MRT141350	MRT241350	\$588.00
2000 (1)	BA1350	MRT101350	MRT201350	\$550.00
Fendt	Vendor ID	Spiked	Razor	Price
Momentum	BA1350	MRT101350	MRT201350	\$550.00
John Deere	Vendor ID	Spiked	Razor	Price
7000, 7100, 7200, 7300, 1700, DB	BA1350	MRT101350	MRT201350	\$550.00
Kinze	Vendor ID	Spiked	Razor	Price
2000, 3000, 4000, 5000	BA1350	MRT101350	MRT201350	\$550.00
White, Massey Ferguson	Vendor ID	Spiked	Razor	Price
6000, 8000, 9000	BA1350	MRT101350	MRT201350	\$550.00
Kronos Optional Accessories		Vendor ID	Product ID	Price
Aluminum Side Treader Wheel (2 required per row); Reduces trenching in soft soils and provides traction in loosely-worked ground.		STW-04A	MRT003003	\$50.00
(1) CIH 2000 series adapter bracket (needed if planter is NOT equipped with CIH#4854385)		900409	MRT900409	\$38.00

**Adjustable Positioning :** Easily adjusts from a 60° to a 50° working angle, no tools required, and adjustments can be made right in the field.



Wide: 60 Degree



Narrow: 50 Degree

The Kronos Row Cleaner includes a built-in cylinder bracket for quick and easy installation of the Clean Sweep air cylinder. Check out page 34 for all Clean Sweep and Smart Clean Air Control System kits.



# ROW CLEANERS

## WA1360 FLOATING ROW CLEANER

**Only requires 19" of clearance**

from planter face plate, 22" when using with a no-till couler, 25" when using with single UMO-150 fertilizer opener, 30" with dual UMO-150.

*Please see spike wheel and razor wheel comparison on page 23.*

- Choice of Spike or Razor wheels can be installed, intersected or offset
- HA44270D Heavy Duty Greaseable Tapered Roller Bearing Hub with triple-lip seal
- Smart Clean, Precision CleanSweep and Cam Adjust compatible

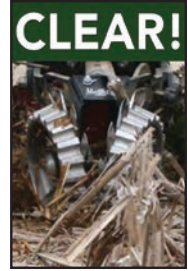

**\* Treader Wheels are sold separately.**

60-degree heavy-duty frame

Shown with side treader wheels, razor wheels and bracket



Choice of Spike or Razor wheels can be installed, intersected or offset

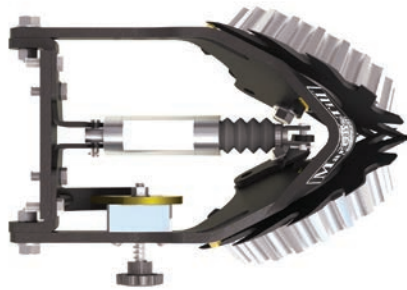

"On our farm, we use the 1360 row cleaner on two Kinze planters. We have been using them for more than 5 years and they have required little to no maintenance. I recommend Martin row cleaners, with confidence, because of their durability and dependability."

Aaron Wolf - Dixon, IL

### WA1360 Floating Row Cleaner For Coulters and Without Coulters

Case-IH		Vendor ID	Spiked	Razor	Price
800, 900, 1200	without no-till coulters	BCIH1360	MRT101385	MRT201385	\$664.00
2000 (1)		BA1360	MRT101386	MRT201386	\$626.00
Fendt		Vendor ID	Spiked	Razor	Price
Momentum	without no-till coulters	BA1360	MRT101386	MRT201386	\$626.00
Harvest International		Vendor ID	Spiked	Razor	Price
Laser Pro	without no-till coulters	BA1360	MRT101386	MRT201386	\$626.00
Horsch		Vendor ID	Spiked	Razor	Price
Maestro	without no-till coulters	BH1360	MRT101383	MRT201383	\$626.00
John Deere		Vendor ID	Spiked	Razor	Price
7000, 7100	without no-till coulters	BA1360	MRT101386	MRT201386	\$626.00
7200, 7300, 1700, DB	without no-till coulters	BA1360	MRT101386	MRT201386	\$626.00
	with OEM unit mount no-till coulters	BDC1360	MRT101368	MRT201368	\$626.00
	with OEM double disc fertilizer openers	BDD1360	MRT101376	MRT201376	\$632.50
Kinze		Vendor ID	Spiked	Razor	Price
2000, 3000, 4000, 5000	without no-till coulters	BA1360	MRT101386	MRT201386	\$626.00
2000, 3000	with OEM double arm, unit mount no-till coulters	BKC1360	MRT101367	MRT201367	\$626.00
4000	with OEM double arm, unit mount no-till coulters	BKC41360	MRT101378	MRT201378	\$626.00
White, Massey Ferguson		Vendor ID	Spiked	Razor	Price
6000, 8000, 9000	without no-till coulters	BA1360	MRT101386	MRT201386	\$626.00
WA1360 Optional Accessories		Vendor ID	Product ID	Price	
Aluminum Side Treader Wheel (2 required per row)		STW-04A	MRT003003	\$50.00	
Cam Adjust Kit, WA1360, all models except Kinze with OEM dual arm no-till coulters		CA-03D	MRT003154	\$90.50	
Cam Adjust Kit, WA1360 for Kinze 2000, 3000 with OEM dual arm no-till coulters only		CA-03K	MRT003155	\$98.50	
Depth blade/filler plate (2 per row) for 13" spiked wheels - eliminates wrapping when planting in to cover crops		BLD9.75	MRT801252	\$40.00	\$40.00
WA1360 Exceptions		Vendor ID	Product ID	Price	
(1) CIH 2000 series bracket (needed if planter is NOT equipped with CIH#4854385)		900409	MRT900409	\$38.00	
Unit set back bracket, John Deere 7000, 7100; all Kinze except 4900		USB-70	MRT003500	\$115.50	
Unit set back bracket, John Deere 7200, 7300, 1700, DB		USB-72	MRT003510	\$164.00	

# ROW CLEANERS



## WA1345 NARROW FLOATING ROW CLEANER



As planters get faster and row width narrower, a less aggressive row cleaner is needed.

- Narrow 45-degree frame, ideal for high speed planting or narrow rows
- CHU44C cast hubs and long life PEER SEEDXTREME 5205 double row bearing with a six-lip seal



**\* Treader Wheels are sold separately.**

WA1345 Narrow Floating Row Cleaner		For Use Without Coulters			
<b>Case-IH</b>		<b>Vendor ID</b>	<b>Spiked</b>	<b>Razor</b>	<b>Price</b>
800, 900, 1200, 2000	without no-till coulters	BCIH1345	MRT301385	MRT401385	\$664.00
2000 (1)		BA1345	MRT301386	MRT401386	\$626.00
<b>Fendt</b>		<b>Vendor ID</b>	<b>Spiked</b>	<b>Razor</b>	<b>Price</b>
Momentum	without no-till coulters	BKW1345	MRT301386	MRT401386	\$626.00
<b>Harvest International</b>		<b>Vendor ID</b>	<b>Spiked</b>	<b>Razor</b>	<b>Price</b>
Laser Pro	without no-till coulters	BA1345	MRT301386	MRT401386	\$626.00
<b>Horsch</b>		<b>Vendor ID</b>	<b>Spiked</b>	<b>Razor</b>	<b>Price</b>
Maestro	without no-till coulters	BH1345	MRT301383	MRT401383	\$626.00
<b>John Deere</b>		<b>Vendor ID</b>	<b>Spiked</b>	<b>Razor</b>	<b>Price</b>
7000, 7100	without no-till coulters	BA1345	MRT301386	MRT401386	\$626.00
7200, 7300, 1700, DB	without no-till coulters	BA1345	MRT301386	MRT401386	\$626.00
<b>Kinze</b>		<b>Vendor ID</b>	<b>Spiked</b>	<b>Razor</b>	<b>Price</b>
2000, 3000, 4000, 5000	without no-till coulters	BA1345	MRT301386	MRT401386	\$626.00
<b>White, Massey Ferguson</b>		<b>Vendor ID</b>	<b>Spiked</b>	<b>Razor</b>	<b>Price</b>
6000, 8000, 9000	without no-till coulters	BA1345	MRT301386	MRT401386	\$626.00
<b>WA1345 Optional Accessories</b>		<b>Vendor ID</b>	<b>Product ID</b>	<b>Price</b>	
Aluminum Side Treader Wheel (2 required per row)		STW-04A	MRT003003	\$50.00	
Cam Adjust Kit, WA1345, all models		CA-45	MRT003176	\$90.50	
Depth blade/filler plate (2 per row) for 13" spiked wheels - eliminates wrapping when planting in to cover crops		BLD9.75	MRT801252	\$40.00	\$40.00
<b>WA1345 Exceptions</b>		<b>Vendor ID</b>	<b>Product ID</b>	<b>Price</b>	
(1) CIH 2000 series bracket (needed if planter is NOT equipped with CIH#4854385)		900409	MRT900409	\$38.00	
Unit set back bracket, John Deere 7000, 7100; all Kinze except 4900		USB-70	MRT003500	\$115.50	
Unit set back bracket, John Deere 7200, 7300, 1700, DB		USB-72	MRT003510	\$164.00	



- Choice of Spike or Razor wheels can be installed, intersected or offset
- Smart Clean, Precision CleanSweep and Cam Adjust compatible

## Choose Spike or Razor Wheel for All Row Cleaners



**With Scraper**      **Without Scraper**

Scrapers come standard with all row cleaners



**SPIKE WHEELS'** intersecting spike teeth lightly till the seed zone.

- Moves the least amount of soil.
- The larger soil window between the teeth allows residue to be moved without moving vital soil away from the row center.
- Performs well in green material, when combined with an internal scraper and a depth blade (filler plate).



**RAZOR WHEELS** cut through tough crop residue and cover crops with ease.

- Made from 1/4" T-1, and heat treated a second time for extended long life.
- The angled teeth drop material as the wheel exits the ground preventing wrapping and, when combined with the scraper, it remains wrap-free even in standing cover crops.





# MARTIN CLOSING WHEELS

## fCRUSHER STANDARD TOOTH CLOSING WHEEL

### Firms and Crumbles at the Same Time

- Tapered tooth design allows firming on one side and crumbling on the other.
- No more wearing one side of plastic until it has to be flipped.
- Long-life ductile cast iron will run for years and years.
- Can be ran in pairs to crumble both sides of seed trench or matched with rubber/cast wheel for economical alternative.



fCrusher Closing Wheel  
MRT800711

fCrusher Closing Wheel	Vendor ID	Product ID	Price/Each
Single 5/8" bearing or 16mm bolt on	800711	MRT800711	\$128.00

Lightweight (9.5 lbs.)  
Drafted tooth keeps its entire  
foot print on the ground.

## fCRUSHER SHORT TOOTH CLOSING WHEEL

The **short-tooth fCrusher** is engineered to provide shallower penetration into the seed trench, ideal for situations where less soil disturbance around the seed is desired, without compromising sidewall disruption.

Each tooth is precision-beveled to efficiently fracture the trench sidewall and guide soil inward, helping to close and seal the trench smoothly and evenly.



fCrusher Closing Wheel Short Tooth  
MRT808711

fCrusher Closing Wheel Short Tooth	Vendor ID	Product ID	Price/Each
Single 5/8" bearing or 16mm bolt on	800711-5	MRT808711	\$128.00

## AFTER-TILL CUPPED SPADING CLOSING WHEEL

Engineered to break tough sidewalls and close seed trenches with precision, the **After-Till Cupped Closing Wheels** deliver a great performance in wet, heavy, and compacted soils. Designed for superior control and consistency.

**Aggressive Sidewall Breakup:** Specialized cupped and beveled spade design fractures sidewalls while sealing the trench with controlled pressure, ideal for challenging planting conditions.

**Optimized Seed Trench Closure:** Provides firm, even closure for enhanced seed-to-soil contact and improved moisture retention.

**Precision Depth Control:** Shorter, refined teeth ensure consistent trench engagement and uniform seed depth.



After-Till Cupped Spading Closing Wheel	Vendor ID	Product ID	Price/Row
5/8" bearing or 16mm bolt on	900646	MRT900646	\$368.00

# MARTIN CLOSING WHEELS



## DUAL 14" CUPPED RAZOR CLOSING WHEEL SET

- Slices sidewalls and opens compacted zones - excels in residue-heavy fields, sod or cover crop conditions.
- Razor profile is wrap free in most cover crops.
- Fractures sidewall



**18-Tooth Cupped Razor** closing wheels are designed specifically for **shallow planted** crops.



14" 18-Tooth Cupped Razor Wheels

Dual 14" 14-Tooth Cupped Razor Closing Wheel Set	Product ID	Price/Row
5/8" bearing or 16mm bolt on	MRT141844	\$368.00
17mm Wheels slide on threaded stud	MRT141843	\$368.00
Water pump style bearing (roll pin)	MRT141841	\$408.00



14" 14-Tooth Cupped Razor Wheels



Dual 14" 18-Tooth Cupped Razor Closing Wheel Set	Product ID	Price/Row
5/8" bearing or 16mm bolt on	MRT181844	\$368.00
17mm Wheels slide on threaded stud	MRT181843	\$368.00
Water pump style bearing (roll pin)	MRT181841	\$408.00

## DUAL 13" SPADING (SPIKE) CLOSING WHEEL SET

*For compaction-free closing of the seed trench in wet or harsh conditions*



BSCW1344  
13" Spike Wheels

- Moves soil toward the seed at planting depth while lifting and fracturing the surface layer
- Forms soil around the seed from each side and loosens the surface layer, enabling crops to emerge sooner and allows planting at the proper depth, without sidewall compaction
- 3/8" thick, right and left toothed steel wheels with 14 teeth & diamond shaped points

Dual 13" Spading Closing Wheel Set	Vendor ID	Product ID	Price/Row
5/8" bearing or 16mm bolt on	BSCW1344	MRT001344	\$340.00
17mm Wheels slide on threaded stud	BSCW1343	MRT001343	\$340.00
Water pump style bearing (roll pin)	BSCW1341	MRT001341	\$380.00
White 5100, Compatible with single 4" x 12" factory closing wheel	BSCW514	MRT005104	\$398.00
White 6100, Compatible with single 4" x 12" factory closing wheel	BSCW614	MRT006104	\$398.00

## SINGLE 15" SPADING (SPIKE) CLOSING WHEEL

*For compaction-free closing of the seed trench in wet or harsh conditions*

- 15" spading closing wheel should be paired with a 12" rubber or cast wheel
- Consistently outperforms two solid rubber closing wheels
- 3/8" thick, 15" diameter right and left toothed steel wheels with diamond shaped points



BSCW1544R  
15" Spike Wheel

Single 15" Spading Closing Wheel	Vendor ID	Product ID	Price/Each
5/8" bearing or 16mm bolt on, left side of row	BSCW1544SL	MRT101544	\$184.00
5/8" bearing or 16mm bolt on, right side of row	BSCW1544SR	MRT201544	\$184.00
17mm Wheels slide on threaded stud, left side of row	BSCW1543SL	MRT101543	\$184.00
17mm Wheels slide on threaded stud, right side of row	BSCW1543SR	MRT201543	\$184.00
Water pump style bearing (roll pin), left side of row	BSCW1541SL	MRT101541	\$204.00
Water pump style bearing (roll pin), right side of row	BSCW1541SR	MRT201541	\$204.00



Spading Closing Wheels Options	Vendor ID	Product ID	Price
Leveling kit, drop down brackets are designed for paired 13" wheels to help maintain a level closing wheel arm assembly in loose soils. For Deere or Kinze with bolt-on 13" spading wheels.	DK-01	MRT004191	\$30.00
Internal deflectors (scrapers) for 13" and 15", 5/8" bolt-on style spading closing wheels. Reduces buildup of mud and residue to insure fractured soil is placed evenly over seed trench.	ITDSCWSET	MRT003149	\$53.00
Filler blade for 15" spading wheels in heavy residue or cover crops.	BLD-12	MRT007110	\$40.00
Filler blade for 13" spiked wheels in heavy residue or cover crops.	BLD10.5	MRT007111	\$40.00

# TWISTED DRAG CHAIN

**Crumbles, fills unclosed areas and levels soil above the seed slot**



- Heavy-duty, square-edged cross chain and brackets
- Attaches to closing wheel brackets
- Bolts to all John Deere Max-Emerge units
- Fits Kinze and White units with bolt-on wheels
- Units with roll pin attached closing wheels will need holes drilled for mounting

Martin-Till Drag Chain Kit		
Description	Product ID	Price
Drag Chain Kit	MRT003600	\$58.00

## 2ND STAGE CLOSER...Seals and levels air pockets

MRT900296  
2nd Stage Closer  
Bracket



(Shown with 6" Rubber Packing Wheel, sold separately.)

(Shown with 4" Rubber Packing Wheel, sold separately. Also shown with optional Martin-Till cupped razor wheels.)

The **fCrumbler** mulches and firms the seed trench without smearing or packing and reduces crusting. This cleat design prevents mud build up from wet conditions or fertilizer application.

Step 1 - 2nd Stage Closer Bracket	Product ID	Price
John Deere XP, ME5 (fits cast brackets only)	MRT900296	\$295.50
Kinze (fits bolt on style brackets only)	MRT900311	\$295.50
White 9000	MRT900312	\$319.50
Packing wheel sold separate, see options below. 2nd Stage Closer is compatible with most closing wheels.		



Shown with 6" Packing wheel and Cupped Razor Closing Wheels both sold separately.

Step 2 - 2nd Stage Closer Packing Wheel	Product ID	Price
4" fCrumbler	MRT900397	\$161.00
4" Rubber	MRT800451	\$98.00
6" Rubber	MRT800419	\$98.00

Step 3 - Attachments	Product ID	Price
Liquid Fertilizer Tube	MRT850339	\$62.00

- Adds 2nd Stage Press wheel (Rubber or fCrumbler) to seal and level air pockets left in seed trench to ensure ideal seed to soil contact.
- Easily mounts to most Double V Style OEM closing wheel brackets.
- Cam Adjust allows adjustment of pressure applied to press wheel.

## MARTIN-TILL CLOSING WHEELS FOR DRILLS

- 1/2" thick, 13" diameter with 20 rounded points crumbles side walls
- 13" Spading Closing Wheels work well in high moisture conditions



MRT075104  
13" 20-Point  
Dimple Closing Wheel



MRT315604  
13" 20-Point Dimple  
Closing Wheel



Drill/Seeder Spading Closing Wheels		Vendor ID	Product ID	Price
Deere 750, 1850	13" single spiked closing wheel, LH	BSCW75BBL	MRT175404	\$185.50
	13" single spiked closing wheel, RH	BSCW75BR	MRT275404	\$185.50
Deere 1560, 1590, 1690, 1860, 1890, 1895, 1990	13" single spiked closing wheel, LH	BSCW156L	MRT115604	\$117.50
	13" single spiked closing wheel, RH	BSCW156R	MRT215604	\$117.50

Drill/Seeder Dimple Closing Wheels		Vendor ID	Product ID	Price
Deere 750, 1850	13" single 20 pt. dimple closing wheel, LH	BSCW75BDL	MRT075204	\$172.00
	13" single 20 pt. dimple closing wheel, RH	BSCW75BDR	MRT075104	\$172.00
Deere 1560, 1590, 1690, 1860, 1890, 1895, 1990	13" single 20 pt. dimple closing wheel	BSCW156D	MRT315604	\$104.00

# CASE-IH CLOSING WHEELS

Martin-Till's Case-IH closing wheels replace the solid closing discs on Case-IH planters.

- Closing wheel arm pressure can be greatly reduced
- Seeding depth does not have to be raised to ensure emergence
- Soil above the seed is loose, allowing quicker emergence in a compaction-free environment
- Sidewall compaction is eliminated

## CASE-IH 9" SPADING (SPIKE) CLOSING WHEEL SET

Spading Closing Wheel Set	Vendor ID	Product ID	Price
Case-IH 800, 900, 1200; (9" spading wheels) Fits Deere or Kinze with shallow closing attachment	BSCW899	MRT089903	\$194.00



## CASE-IH CUPPED RAZOR CLOSING WHEEL SETS



Cupped Razor Closing Wheel Set	Vendor ID	Product ID	Price
Case-IH 800, 900, 1200; (8" cupped wheels) Fits Deere or Kinze with shallow closing attachment	900583	MRT900583	\$194.00
Case-IH 2000 series (9" cupped wheels)	BSCW9ZC-2000	MRT089922	\$194.00

## CASE-IH CUPPED SPADING CLOSING WHEEL SETS

Cupped Spading Closing Wheel Set	Vendor ID	Product ID	Price
Case-IH 800, 900, 1200; (8" cupped spade wheels)	900577	MRT900577	\$194.00
Case-IH 2000 series (9" cupped spade wheels)	900578	MRT900578	\$194.00



## CASE-IH 9" CAMBER ADJUST CLOSING KIT

Changes angle of Case standard stance to V-style for better gathering action



MRT900252  
Camber Adjust  
V-Style Closing Kit

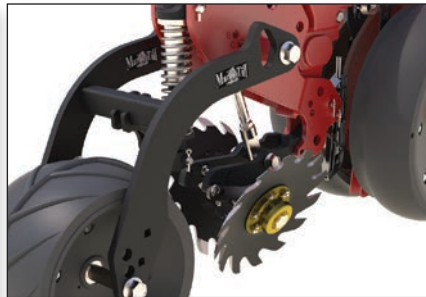

Packing wheel and  
closing wheel are  
not included.

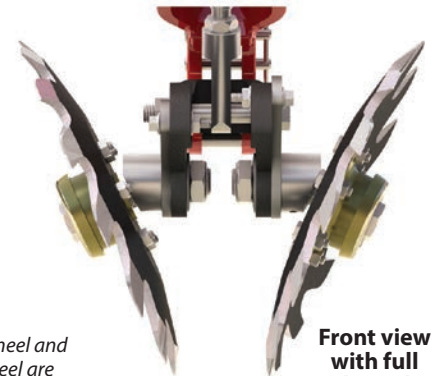

Front view  
with full  
camber adjust

- New axles allow fine adjustment of Toe-in to fit your specific environmental needs
- The sharpened teeth chip the side wall while forcing soil towards the seed to close the furrow
- Updated swing arm with more clearance means less plugging

Case-IH Camber Adjust V-Style Closing Kit	Vendor ID	Product ID	Price
Case-IH 2000	900252	MRT900252	\$487.00

Case-IH Packing Wheel Options	Vendor ID	Product ID	Price
4" fCrumbler	900397	MRT900397	\$161.00
4" Rubber	800451	MRT800451	\$98.00
6" Rubber	800419	MRT800419	\$98.00

## CLOSING WHEEL ANGLE CHANGER FOR CNH AIR DRILLS

CNH Air Drill Closing Wheel Angle Changer	Product ID	Price
CNH 500T Closing wheel angle changer, Left Hand	MRT900307	\$197.50
CNH 500T Closing wheel angle changer, Right Hand	MRT900308	\$197.50

Adjustable Angle Changer for  
CNH 500T Air Drills. 0-11 degree  
adjustments with quick adjust knob.



# WEIGHT TRANSFER SYSTEM

## Re-distributes Weight from the Center of the Planter to the Wings

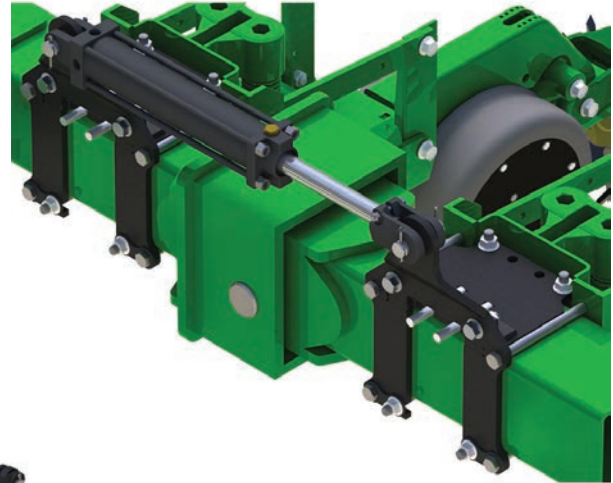

The transfer of the weight from the center of the planter to the wings reduces compaction and ground pressure, which more evenly distributes the weight to where it is needed most.

### Kit Includes:

- In-Cab Control Box with harness (electronic PWM version)
- Hydraulic cylinders and durable hydraulic valves
- Bolt-on brackets
- Grade 8 mounting hardware



Featured in  
**NO-TILL FARMER**  
The No-Till Authority Since 1972



## Eliminate Pinch Row Compaction

- Pinch row compaction leads to shorter, stunted plants, restricted roots and ultimately yield loss. Pinch row compaction can have a negative consequence to getting crops off to the right start.
- Restricted root growth will negatively impact nutrient uptake even when soil test values indicate sufficient nutrition.
- **In-Cab Control Box**—Allows for easy adjustment as you plant. This rugged control box allows for fine tuning of the industry-standard hydraulic valve.
- **Hydraulic Control Kit** provides durable and quick adjustment



NOTE: Can be used with Frame Mounted Opener  
NOTE: Kit does not include custom hydraulic hoses or fittings

Interlocking tab and slot design fit together to transfer load across the tool bar.

Weight Transfer System			
Case-IH	Description	Product ID	Price
1255	24 Row, 30"	MRT900454	\$7,800.00
Harvest International	Description	Product ID	Price
Laser Pro 1	12 row, 16 Row 30" on JD 1770/1775 Bar	MRT900220	\$6,000.00
John Deere	Description	Product ID	Price
1770-1775 NT 2022 & older	12 Row, 30"	MRT900356	\$6,000.00
	16 Row, 30"	MRT900083	\$6,000.00
1775 NT 2023 & newer	12 Row, 30"	MRT900572	\$6,000.00
	16 Row, 30"	MRT900081	\$6,000.00
1770-1775 NT	24 Row, 30"	MRT900244	\$7,800.00
1790	24 Row, 20"	MRT900320	\$6,000.00
1790, 1795	16-31/32 Row, 15"	MRT900283	\$5,500.00
DB60	All row configurations Stacked bar only	MRT900441	\$7,800.00
Massey Ferguson	Description	Description	Price
	24 Row, 20"	MRT900600	\$6,000.00

# MARTIN REPLACEMENT PARTS

## ROW CLEANER REPLACEMENT PARTS

Replacement Wheels	Vendor ID	Product ID	Price
Standard wheel, 13" 3 & 4-bolt, LH on row cleaner	TW3813-L	MRT343905	\$79.50
Standard wheel, 13" 3 & 4-bolt, RH on row cleaner	TW3813-R	MRT343906	\$79.50
Standard wheel, 13" 6-bolt (Kinze hole pattern)	TW3813-LK	MRT003909	\$87.00
Standard wheel, 13" 6-bolt (Kinze hole pattern)	TW3813-RK	MRT003910	\$87.00
Razor wheel, 12.5" 3 & 4-bolt, RH on row cleaner	RTW1412.5R4	MRT141250	\$79.50
Razor wheel, 12.5" 3 & 4-bolt, LH on row cleaner	RTW1412.5L4	MRT141251	\$79.50
Razor wheel, 12.5" 6-bolt, LH on row cleaner (Kinze hole pattern)	TW1412.5LK	MRT141252	\$87.00
Razor wheel, 12.5" 6-bolt, RH on row cleaner (Kinze hole pattern)	TW1412.5RK	MRT141253	\$87.00

Standard  
(Spike)  
Wheel

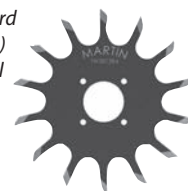

Razor  
Wheel

Hub & Axles	Vendor ID	Product ID	Price
Hub & Axle, 3-bolt, for pin adjust row cleaners, WA1317, WA1330	HA13305-D	MRT003908	\$114.50
Hub & Axle, 3-bolt, for floating row cleaners, C125	HA13270-D	MRT003902	\$114.50
Hub & Axle, 4-bolt, for row cleaners, C125, ACCR1360, WA1360, WA1332, WA1334, WA1532	HA44270-D	MRT003907	\$114.50
Hub with hardware, 4-bolt, for floating row cleaners, WA1345, ACCR1345, BA1350	CHU44-C	MRT900101	\$114.50



Hub & Axle  
MRT003907



Hub  
MRT900101

Bearings/Bearing Kits	Vendor ID	Product ID	Price
Bearing, for row cleaner, WA1345	800248	MRT800248	\$46.50
Bearing kit, for row cleaner, C125, ACCR1360, WA1360, WA1332, WA1334, WA1532	HR KIT	MRT003912	\$40.00

Wheel and Hub Assemblies For 1345/1350 Row Cleaners	Vendor ID	Product ID	Price
12.5" Razor Wheel Complete Assembly, LH, WA1345, ACCR1345, BA1350	900155	MRT900155	\$247.50
12.5" Razor Wheel Complete Assembly, RH, WA1345, ACCR1345, BA1350	900156	MRT900156	\$247.50
13" Spike Wheel Complete Assembly, LH, WA1345, ACCR1345, BA1350	900152	MRT900152	\$247.50
13" Razor Wheel Complete Assembly, RH, WA1345, ACCR1345, BA1350	900153	MRT900153	\$247.50

Wheel and  
Hub Assembly  
MRT900152



Wheel and Hub Assemblies For 1360 Row Cleaners	Vendor ID	Product ID	Price
12.5" Razor Wheel Complete Assembly, LH, WA1360, ACCR1360	900097	MRT900097	\$247.50
12.5" Razor Wheel Complete Assembly, RH, WA1360, ACCR1360	900098	MRT900098	\$247.50
13" Spike Wheel Complete Assembly, LH, WA1360, ACCR1360	900179	MRT900179	\$247.50
13" Spike Wheel Complete Assembly, RH, WA1360, ACCR1360	900178	MRT900178	\$247.50

Wheel and  
Hub Assembly  
MRT900097



WA Row Cleaner Mounts	Vendor ID	Product ID	Price
CIH 800, 900, 1200, 2000; without no-till couler	MT1360CIH	MRT900514	\$135.00
HI Laser Pro; JD 7000, 7100; Kinze 2000, 3000; White 6000, 8000, 9000; without no-till couler	800901	MRT800901	\$97.00
JD 7200, 7300, 1700, DB; without no-till couler	MT1360DS	MRT001362	\$97.00
Horsch Maestro without no-till couler	MRT001383	MRT001383	\$97.00
JD 7200, 7300, 1700, DB; with OEM unit mount no-till couler	MT1360DC	MRT001368	\$97.00
JD 7200, 7300, 1700, DB; with OEM double disc fertilizer opener	MT1360DD	MRT001376	\$103.50
Kinze 2000, 3000; with OEM double arm unit mount no-till couler	MT1360KC	MRT001367	\$97.00
Kinze 4900; without no-till couler	MT1360K4	MRT001377	\$97.00
Kinze 4900; with OEM double arm unit mount no-till couler	MT1360K4C	MRT001378	\$97.00

Row Cleaer  
Mount  
MRT800901



Row Cleaner  
Mount  
MRT001368

Dust Caps	Vendor ID	Product ID	Price
Dust cap, C125, ACCR1360, WA1360, WA1332, WA1334, WA1532	HS1328	MRT004174	\$4.50
Dust cap, WA1345, ACCR1345	800244	MRT800244	\$4.50

# MARTIN REPLACEMENT PARTS

Scraper Sets/Parts	Vendor ID	Product ID	Price
Scraper set row cleaner; C125, WA1360, ACCR1360	DLD-02 SET	MRT003160	\$53.00
Scraper LH row cleaner; C125, WA1360, ACCR1360	DLD-02L	MRT003162	\$26.50
Scraper RH row cleaner; C125, WA1360, ACCR1360	DLD-02R	MRT003163	\$26.50
Scrapers set, spiked closing wheel, WA1345, ACCR1345	ITDSCWSET	MRT003149	\$53.00
Scraper LH, spiked closing wheel, WA1345, ACCR1345	ITDSCWL	MRT003150	\$26.50
Scraper RH, spiked closing wheel, WA1345, ACCR1345	ITDSCWR	MRT003151	\$26.50



Scraper Set  
MRT003160

Row Cleaner Parts	Vendor ID	Product ID	Price
Row cleaner frame, C125	C125FR	MRT003958	\$141.00
Row cleaner frame, WA1345, Requires 2 MRT800510 bushing	FR1345	MRT003952	\$141.00
Row cleaner frame, WA1360, Requires 2 MRT800510 bushing	900174	MRT900174	\$141.00
Bushing, row cleaner pivot point, old style; 7/8" OD	BU7858	MRT004171	\$4.50
Bushing, row cleaner pivot point, current style; 1-3/32 OD	800510	MRT800510	\$4.50
Flange Bolt, row cleaner pivot, 5/8 X 2" GR8	783620	MRT783620	\$2.97
Flange Lock Nut, row cleaner pivot, 5/8-11 GR8	785600	MRT785600	\$1.71



WA1360 Frame  
MRT900174



WA1345 Frame  
MRT003952

## CLOSING WHEEL REPLACEMENT PARTS

Replacement Wheels	Vendor ID	Product ID	Price
Standard wheel, 13" 3 & 4-bolt, LH on row cleaner	TW3813-L	MRT343905	\$79.50
Standard wheel, 13" 3 & 4-bolt, RH on row cleaner	TW3813-R	MRT343906	\$79.50
Standard wheel, 15" 3 & 4-bolt, LH on row cleaner	TW3815-L4	MRT344177	\$93.50
Standard wheel, 15" 3 & 4-bolt, RH on row cleaner	TW3815-R4	MRT344178	\$93.50
Cupped razor wheel, 14", 14 Tooth, 4-bolt, RH on closing wheels	RTW1414L	MRT004207	\$93.50
Cupped razor wheel, 14", 14 Tooth, 4-bolt, LH on closing wheels	RTW1414R	MRT004208	\$93.50
Cupped razor wheel, 14", 18 tooth, 4-bolt, RH on closing wheels	RTW141418LC	MRT004213	\$93.50
Cupped razor wheel, 14", 18 tooth, 4-bolt, LH on closing wheels	RTW141418RC	MRT004214	\$93.50
Dimple wheel, 13", 4-bolt, LH and RH on closing wheels	DW2013-4	MRT003923	\$66.00



MRT343905 & MRT343906



MRT004207 & MRT004208

Hub & Axles	Vendor ID	Product ID	Price
Hub, 3-bolt, for closing wheels with single bearing, 5/8" or 16 mm I.D.	CHU024	MRT003903	\$63.00
Hub, 3-bolt, for closing wheels with two bearings, 17mm I.D.	CHU022	MRT004167	\$63.00
Hub, 4-bolt, for closing wheels with single bearing, 5/8" or 16 mm I.D.	CHU44-B2	MRT004190	\$90.50
Hub, 4-bolt, for closing wheels with two bearings, 17mm I.D.	CHU44-A	MRT004175	\$90.50



MRT004190

Bearing Kits	Vendor ID	Product ID	Price
Bearing kit, 3-bolt, for closing wheels with two bearings, 17mm I.D.	CHU022BK	MRT004173	\$36.00
Bearing kit, 4-bolt, for closing wheels with single bearing, 5/8" or 16mm I.D.	CHU44B-BK	MRT004184	\$35.50
Bearing kit, 4-bolt, for closing wheels with two bearings, 17mm I.D.	CHU44A BK	MRT004197	\$38.00



Bearing  
Kit, 4-Bolt  
MRT004184

Dust Caps	Vendor ID	Product ID	Price
Dust cap, 3-bolt, closing wheels	HS1080	MRT004163	\$2.50
Dust cap, WA1345, ACCR1345	800244	MRT800244	\$4.50



MRT800244

# UNIT-MOUNTED FERTILIZER OPENER (UMO)

Single  
UMO-150

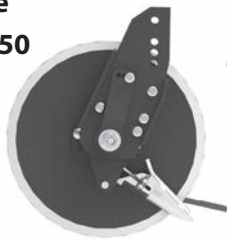

Standard 14" smooth  
blade for use in no-till  
conditions...

OR

Notched 15" blade  
for use in min-till or  
conventional till

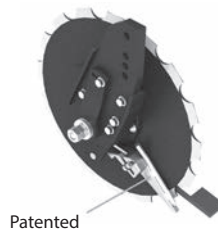

Consistently places  
fertilizer in the ground  
without splattering it  
on the planter!

## UNIT-MOUNTED FERTILIZER OPENER

Step 1A UMO-150 for no-till	Vendor ID	Product ID	Price
Single UMO-150, standard 14" smooth blade, left	UMO-150L	MRT100150	\$538.00
Single UMO-150, standard 14" smooth blade, right	UMO-150R	MRT200150	\$538.00
Double UMO-150, standard 14" smooth blade, left		MRT300150	\$1,076.00
Double UMO-150, standard 14" smooth blade, right		MRT400150	\$1,076.00
Step 1B UMO-150 for min-till/conventional-till	Vendor ID	Product ID	Price
Single UMO-150, 15" notched blade, left	900171	MRT900171	\$552.50
Single UMO-150, 15" notched blade, right	900172	MRT900172	\$552.50
Double UMO-150, 15" notched blade, left		MRT300171	\$1,102.00
Double UMO-150, 15" notched blade, right		MRT400172	\$1,102.00
Step 2A Single UMO Mounting Bracket	Vendor ID	Product ID	Price
John Deere 7200-1700, White 9000; single UMO	UMO-MTJ	MRT000300	\$52.00
John Deere 7000, 7100 and Kinze 2000, 3000; single UMO	UMO-MTA	MRT000301	\$52.00
White 8000; single UMO	UMO-MTW	MRT000302	\$52.00
Step 2B Single UMO Mounting Bracket (row cleaner ready)	Vendor ID	Product ID	Price
Case-IH 1200, 2000; single UMO	MT1360CU	MRT001371	\$130.00
John Deere 7200-1700, White 9000; single UMO	MT1360DU	MRT001365	\$111.50
John Deere 7000, 7100; Kinze 2000, 3000; White 6000, 8000; single UMO	MT1360KU/WU	MRT001363	\$111.50
Kinze 4900	MT1360K4U	MRT001379	\$111.50
Step 2C Dual UMO Mounting Bracket (row cleaner ready)	Vendor ID	Product ID	Price
CIH 1200, 2000; dual UMO; requires CIH#48054385	MT1360DDU	MRT001381	\$142.00
John Deere 7200-1700; White 9000 dual; dual UMO	MT1360DDU	MRT001381	\$142.00
John Deere 7000, 7100; Kinze; White 6000, 8000; dual UMO	MT1360KDU	MRT001380	\$142.00
Step 3A Optional WA1360 Row Cleaner	Vendor ID	Product ID	Price
WA1360 row cleaner with 13" spiked wheels	WA1360	MRT001360	\$529.00
WA1360 row cleaner with 12.5" razor wheels	WA1360Z	MRT136017	\$529.00
Step 3B Optional WA1345 Row Cleaner	Vendor ID	Product ID	Price
WA1345 row cleaner with 13" spiked wheels	WA1345	MRT001345	\$529.00
WA1345 row cleaner with 12.5" razor wheels	WA1345Z	MRT134517	\$529.00
Step 4 Optional Accessories	Vendor ID	Product ID	Price
Aluminum Side Treader Wheel (2 required per row)	STW-04A	MRT003003	\$50.00
(1) CIH 2000 series heavy duty adapter bracket (needed if planter is NOT equipped with CIH#4854385)	900023	MRT003945	\$66.00
Case-IH 1200, Heavy duty lower parallel linkage set	HDP-CIH01	MRT007106	\$163.00

UMO Replacement Parts	Vendor ID	Product ID	Price
Bearing, row cleaner, UMO	L44643	MRT003917	\$10.00
Bearing kit, UMO (includes two bearings, two seals and two races)	UMO-HRKIT	MRT003937	\$33.00
Poly strap, UMO	UMO-FCS01	MRT007101	\$16.50
Metal strap, UMO	UMO-FCS02	MRT007102	\$21.00
14" standard blade, UMO	UMO-BLD01	MRT007104	\$52.00
15" notched blade, UMO	800249	MRT800249	\$65.00
Hub, UMO	HU44-F	MRT007107	\$63.00
Spring, UMO, LH	UMO-SPG01L	MRT100301	\$20.00
Spring, UMO, RH	UMO-SPG01R	MRT200301	\$20.00
Furrow Shoe, LH, UMO	UMO-041L	MRT100305	\$96.00
Furrow Shoe, RH, UMO	UMO-041R	MRT200305	\$96.00

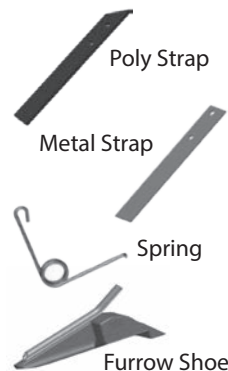

Adjustable Furrow  
Control Strap  
keeps soil in place.

It prevents the  
blow-out of  
furrow walls.

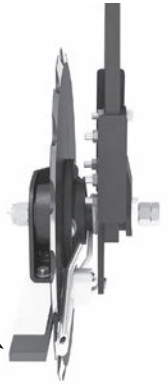

IMPROVED design allows  
more ground clearance with  
a more narrow profile

Furrow control strap reduces furrow  
blow-out while minimizing erosion and  
fertilizer splattering.

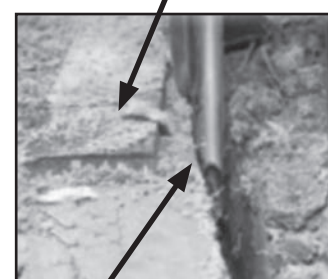

Spring loaded furrow shoe places liquid  
in the ground not on the planter.

### FEATURES OF UMO-150:

- Sturdy compact design
- Greaseable Double tapered bearing hub with two triple lip seals
- 5mm thick (0.197") 14" smooth blade or 15" notched blade
- Updated & improved placement shoe for less friction
- Adjustable furrow control strap keeps soil in place
- Can be set to place liquids 1", 2", or 3" from seed row
- Can also be set to place liquids 3/4" above, or even with seed depth



# PIN-ADJUST/RIGID ROW CLEANERS

The Martin original style row cleaner clears the widest path of any tooth wheel row cleaner on the market.

The 15" diameter, 3/8" thick, T-1 heat-treated wheels are made left and right in order to shed the residue better.

## Step 1 Martin Pin-Adjust Row Cleaners

Description	Product ID	Vendor ID	Price
Pin-adjust row cleaner, narrow row, 1-1/2" stem, 13" wheels	MRT001320	WA1320N	\$486.00
Pin-adjust row cleaner, 1-1/2" stem, 13" wheels	MRT001332	WA1332	\$488.50
Pin-adjust row cleaner, 2" stem for Case-IH planters, 13" wheels	MRT001334	WA1334	\$488.50
Pin-adjust row cleaner, 1-1/2" stem, 15" wheels	MRT001532	WA1532	\$516.50

## Step 2 Martin Pin-Adjust Mounting Brackets

Description	Product ID	Vendor ID	Price
Case-IH 800, 900 series without heavy duty down pressure springs, accepts 2" stem wheel assemblies	MRT000892	MT892	\$89.50
Case-IH 1200, 1300 series, accepts 2" stem wheel assemblies	MRT001250	MT1250	\$89.50
Deutz-Allis Quadra Disk, Landoll, accepts 1-1/2" stem wheel assemblies	MRT002400	MT385	\$91.50
John Deere, Kinze, White EARLY 6000 series with REGULAR down pressure springs and White 9000, accepts 1-1/2" stem wheel assemblies	MRT002000	MT772	\$113.00
Kinze 4900 w/o pneumatic down pressure, accepts 1-1/2" stem wheel assemblies	MRT004772	MT4772	\$113.00
White 5000 series, accepts 1-1/2" stem wheel assemblies	MRT002200	MT512	\$91.50
White EARLY 6000 series with HEAVY duty down pressure springs, accepts 1-1/2" stem wheel assemblies	MRT000610	MT610	\$113.00
White LATE 6000 series and all 8000 series, accepts 1-1/2" stem wheel assemblies	MRT002100	MT810	\$113.00

# TWIN ROW, ROW CLEANERS



- Compact design - just 15-1/2" from row unit faceplate!
- Uses HA44270D heavy-duty greasable tapered roller bearing hub with 2 lip seal
- Over 5" travel while maintaining a consistent wheel stance when riding over uneven ground.

Make/Model		Spiked	Razor	Price
Great Plains; Harvest International John Deere; Kinze	Left Hand	MRT900463	MRT955463	\$521.00
	Right Hand	MRT900464	MRT955464	
It is recommended to run a Clean Sweep system or a Smart Clean Air System with Twin Row Cleaners.				

## Optional Accessories

	Vendor ID	Product ID	Price
Aluminum Side Treader Wheel. Reduces trenching in soft soils and provides traction in loosely-worked ground.	STW-04A	MRT003003	\$50.00
Depth blade/filler plate (2 per row) for 13" spiked wheels - eliminates wrapping when planting in to cover crops	BLD9.75	MRT801252	\$40.00

# MARTIN COMPRESSORS



**Hydraulic High-Flow Compressor Kit MRT900591**

- Hydraulic valve: 12V, 4 GPM set point, pull and release override
- 14cc Hydraulic gear motor
- Inlet air filter: 5 micron element
- 150 psi max working pressure
- 5v; 0-150 psi tank pressure sensor
- 10 gallon tank



**VIAIR 12v Compressor Kit MRT900469**

- 480C VIAIR compressor mounted on a 2.0 gallon air tank
- Pre-wired 165/200 PSI pressure switch
- 1/2-inch port compression fitting for 3/8" (I.D.) air line pre-installed
- Heavy Duty harness with 40-amp relay and an appropriately-rated fuse



**VIAIR 12v Compressor Upgrade Kit for John Deere MRT900481**

- Replaces factory JD compressor
- Comes complete with mounting brackets and deutch connector to connect directly to JD harness. Uses JD pressure switch
- Low amp-draw 480C VIAIR compressor mounted 2 gallon air tank
- 1/2-inch port compression fitting for 3/8" (I.D.) air line pre-installed

## Martin-Till Compressor Kits

Description	Product ID	Price
Hydraulic High-Flow Compressor Kit; 10 gal tank, 3 CFM @ 125 PSI	MRT900591	\$4,800.00
VIAIR 12v Compressor Kit; includes power harness	MRT900469	\$1,310.00
VIAIR 12v Compressor Upgrade Kit for John Deere; includes mounting brackets, reuse factory harness	MRT900481	\$850.00

# ROW CLEANER AIR CONTROL SYSTEMS

The following three Row Cleaner Air Control Systems allow the operator to raise and lower floating row units on-the-go by varying the amount of air pressure in the cylinders. Since adjustments are easy, you will make adjustments when you should.

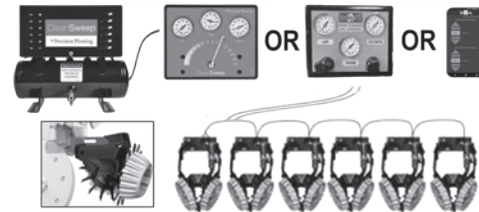

## CleanSweep® Air Control System

**Manage your row cleaner performance, from the cab, on the go.**

CleanSweep is a dual air cylinder that lets you set and adjust your row cleaners' down pressure from the cab.

Have heavy residue? Add more pressure to sweep away the debris. Have light residue or soft ground? Lighten the pressure and keep the row cleaner floating across the top.

The cylinders have a control box mounted in the cab. You set the pounds of pressure from your cab based on the conditions you are in. Plus, the pressurized cylinder gives the row cleaner the ability to adjust or "float" across the small changes you encounter such as terrain or varying amounts of debris.



## Martin-Till

### Manual Bidirectional Air Control System

**Adjust your row cleaners on-the-go from the cab.**

The Martin-Till Manual Bidirectional Air Control System allows for pressurizing both sides of the cylinder at the same time.

Providing additional PSI to the opposing end of the cylinder reduces bounce and allows for fine tuning. The kit includes the control box, a compressor (if required), the necessary air line kit and air cylinders.



Control box and air line



**Adjust row cleaners on-the-go with your smartphone, tablet or ISOBUS-compatible in-cab monitor**

## SmartClean

By Martin

### Air Control System

The exclusive Martin-Till® Smart Clean™ Row Cleaner Adjustment System combines a wireless connection with an easy-to-use mobile app.

- Electronic Proportional Control valves automatically adjust to maintain desired PSI.
- Wireless control allows for less equipment in the cab.



**ISOBUS connection for easy control through your in-cab monitor**

**Consider High Flow Air Line Kits for faster response on larger planters.**

Charts for row cleaner air control systems are on page 34-35. Cylinder parts and accessories; compressor/controller components; and air line kits are on page 35.

# ROW CLEANER CONTROL SYSTEMS

## Step 1: CleanSweep/Smart Clean System Kit (1 Kit Per Planter)

Kits Without Compressor (includes, controller, air line/fittings kit, and air cylinders)

Planter Rows	Precision Planting CleanSweep		Martin Manual Bidirectional Control		Martin-Till SmartClean Bidirectional - Standard Flow		Martin-Till SmartClean Bidirectional - High Flow	
	Product ID	Price	Product ID	Price	Product ID	Price	Product ID	Price
6	PPM855006	\$1,915.00	MRT858706	\$2,096.00	MRT908106	\$6,225.00	-	-
8	PPM855008	\$2,255.00	MRT858708	\$2,436.00	MRT908108	\$6,565.00	-	-
12	PPM855012	\$3,040.00	MRT858712	\$3,221.00	MRT908112	\$7,350.00	MRT988112	\$8,659.00
16	PPM855016	\$3,825.00	MRT858716	\$4,006.00	MRT908116	\$8,135.00	MRT988116	\$9,692.00
23	PPM855023	\$5,170.00	MRT858723	\$5,351.00	MRT908123	\$9,480.00	MRT988123	\$11,411.00
24	PPM855024	\$5,340.00	MRT858724	\$5,521.00	MRT908124	\$9,650.00	MRT988124	\$11,581.00
31	PPM855031	\$6,770.00	MRT858731	\$6,951.00	MRT908131	\$11,080.00	MRT988131	\$13,359.50
32	PPM855032	\$6,940.00	MRT858732	\$7,121.00	MRT908132	\$11,250.00	MRT988132	\$13,529.50
36	PPM855036	\$7,620.00	MRT858736	\$7,801.00	MRT908136	\$11,930.00	MRT988136	\$15,033.50
48	PPM855048	\$9,900.00	MRT858748	\$10,081.00	MRT908148	\$14,210.00	MRT988148	\$18,310.00
54	PPM855054	\$11,070.00	MRT858754	\$11,251.00	MRT908154	\$15,380.00	MRT988154	\$21,090.00

Kits With Compressor (includes compressor, controller, air line/fittings kit, and air cylinders)

Planter Rows	Precision Planting CleanSweep		Martin Manual Bidirectional Control		Martin-Till SmartClean Bidirectional - Standard Flow		Martin-Till SmartClean Bidirectional - High Flow	
	Product ID	Price	Product ID	Price	Product ID	Price	Product ID	Price
6	PPM825006	\$3,170.00	MRT828706	\$3,351.00	MRT918106	\$7,575.00	-	-
8	PPM825008	\$3,510.00	MRT828708	\$3,691.00	MRT918108	\$7,915.00	-	-
12	PPM825012	\$4,295.00	MRT828712	\$4,476.00	MRT918112	\$8,700.00	MRT998112	\$10,009.00
16	PPM825016	\$5,080.00	MRT828716	\$5,261.00	MRT918116	\$9,485.00	MRT998116	\$11,042.00
23	PPM825023	\$6,425.00	MRT828723	\$6,606.00	MRT918123	\$10,830.00	MRT998123	\$12,761.00
24	PPM825024	\$6,595.00	MRT828724	\$6,776.00	MRT918124	\$11,000.00	MRT998124	\$12,931.00
31	PPM825031	\$8,025.00	MRT828731	\$8,206.00	MRT918131	\$12,430.00	MRT998131	\$14,709.50
32	PPM825032	\$8,195.00	MRT828732	\$8,376.00	MRT918132	\$12,600.00	MRT998132	\$14,879.50
36	PPM825036	\$8,875.00	MRT828736	\$9,056.00	MRT918136	\$13,280.00	MRT998136	\$16,383.50
48	PPM825048	\$11,155.00	MRT828748	\$11,336.00	MRT918148	\$15,560.00	MRT998148	\$19,660.00
54	PPM825054	\$12,325.00	MRT828754	\$12,506.00	MRT918154	\$16,730.00	MRT998154	\$22,440.00

## Step 2: Cylinder Bracket (1 Kit Per Row)

Martin ACCR1360/1345	Make/Model	Product ID	Price
ACCR1360, ACCR1345	All models, cylinder bracket is integrated on row cleaner, no additional bracket is needed.	-	-
Martin WA1360	Make/Model	Product ID	Price
W/out no-till coulter; BD, BK, BW, BCIH (5)	<b>Case-IH</b> 800, 900, 1200, 2000; <b>John Deere</b> 7000, 7200, 7300, 1700, DB; <b>Kinze</b> 2000, 3000, 4000; <b>White</b> 6000, 8000, 9000	PPM755200	\$45.00
With no-till coulter; BDC (1)	<b>John Deere</b> 7200, 1700, DB	PPM755205	\$45.00
With UMO	RH bracket, All models with WA1360 and UMO's	MRT803973	\$76.00
	LH bracket, All models with WA1360 and UMO's	MRT803974	\$76.00
With no-till coulter; BKC	Kinze models with OEM double arm no-till coulter	MRT803977	\$87.00
Martin WA1345	Make/Model	Product ID	Price
W/out no-till coulter; BD (5)	<b>Case-IH</b> 800, 900, 1200, 2000; <b>Harvest Int;</b> <b>John Deere</b> 7200, 7300, 1700, DB	MRT803975	\$45.00
W/out no-till coulter; BK, BW	<b>John Deere</b> 7000, 7100; <b>Kinze</b> 2000, 3000; <b>White</b> 6000, 8000, 9000	MRT803976	\$45.00
With UMO	LH bracket, All models with WA1345 and UMO's	MRT803978	\$76.00
	RH bracket, All models with WA1345 and UMO's	MRT803979	\$76.00
Martin C125	Make/Model	Product ID	Price
With no-till coulter; MTR, MTR-XP (1,3)	<b>John Deere</b> 7200, 7300, 1700, DB; <b>White</b> 6000, 9000	PPM755195	\$55.00
With no-till coulter; MTR, MTR-81 (5)	<b>Case-IH</b> 800, 900, 1200; <b>John Deere</b> 7000, 7100; <b>White</b> 5000, 6000, 8000	PPM755225	\$50.00

Chart continued on next page

# ROW CLEANER CONTROL SYSTEMS

Step 2: Cylinder Bracket (1 Kit Per Row)- Continued			
Martin C125 (Continued)	Make/Model	Product ID	Price
Without no-till coulter MTS, MTR, MTS-XP, MTS-81, MTS-IH (5)	Case-IH 800, 900, 1200; John Deere 7000, 7200, 7300, 1700, DB; Kinze 2000, 3000, 4000	PPM755190	\$60.00
With UMO, pack of two	All models with C125 and UMO's, includes 1 LH & 1 RH bracket	PPM755924	\$315.00
Kinze OEM Row Cleaner	Make/Model	Product ID	Price
Double arm coulter, welded style	Kinze 2000, 3000	PPM755925	\$65.00
Double arm coulter, cast style	Kinze 2000, 3000	PPM755926	\$70.00
Row cleaner/coulter combo	Kinze 4900	PPM755932	\$75.00
Yetter Residue Manager	Make/Model	Product ID	Price
2967-007 (2)	John Deere 7000, 7200, 7300, 1700, DB; Kinze 2000, 3000, 4000; White 6000, 9000	PPM755185	\$45.00
2967-008 (5)	Case-IH 800, 900, 1200, 2000	PPM755930	\$65.00
2967-013 (4)	John Deere 7000, 7200, 7300, 1700, DB; Kinze 2000, 3000, 4000; White 6000, 8000, 9000	PPM755270	\$85.00
2967-014 (4,5)	Case-IH 800, 900, 1200, 2000	PPM755250	\$55.00
2967-029 (4)	John Deere 7000, 7200, 7300, 1700, DB; Kinze 2000, 3000, 4000; White 6000, 8000, 9000	PPM755265	\$75.00
2967-035 (2,3)	John Deere 7200, 7300, 1700, DB; Kinze 2000, 3000, 4000; with no-till coulter	PPM755180	\$75.00
2967-035	John Deere 7000, White 6000, 8000, 9000	PPM755230	\$70.00
2967-035; with short bracket	John Deere 7000, 7200, 7300, 1700, DB; Kinze 2000, 3000, 4000; White 6000, 8000, 9000	PPM755175	\$45.00
2967-042 (2,5)	John Deere 7000, 7200, 7300, 1700, DB	PPM755160	\$45.00
2967-097 (5)	Case-IH 800, 900, 1200, 2000	PPM755245	\$70.00
2967-115	John Deere 7200, 7300, 1700, DB; Kinze 2000, 3000, 4000	PPM755170	\$45.00
Cylinder Bracket Accessories		Product ID	Price
(1) Stop Kit, required on John Deere 7200 & 1700 with long parallel arms and row unit mounted fertilizer or no-till coulter.		PPM726530	\$40.00
(2) Stop Kit, required on John Deere 7200 & 1700 with long parallel arms and row unit mounted fertilizer or no-till coulter.		PPM755202	\$30.00
(3) Cylinder Base Mount Shim, required when using a John Deere cast coulter.		PPM755159	\$8.00
(4) Pin Kit, Yetter Residue Manager Models 2967-013A, 2967-14A, 2967-029A, 2967-097A, made 2016 and after. These models come equipped with cylinder brackets and only require this pin kit to install cylinder.		PPM755255	\$6.00
(5) CleanSweep is not compatible with Case-IH 12X5 series planters unless DeltaForce is installed. May require additional stop kit.			
Step 3: Optional Accessories			
Optional ISOBUS Harness For SmartClean Control (control system through existing display)		Product ID	Price
ISOBUS harness, John Deere planter with ISOBUS		MRT800535	\$200.00
ISOBUS harness, All planters without ISOBUS, must have ISOBUS connection at the tractor		MRT900384	\$750.00
ISOBUS harness, All planters other than John Deere with ISOBUS		MRT900383	\$1,150.00
Optional Compressor Mounting Kit		Product ID	Price
John Deere 7000, 7200, 1770, 1770NT, 1790 (mounts on draft tube)		PPM726050	\$55.00
Kinze 2600, 3600, 12R (mounts to tongue)		PPM726058	\$155.00
John Deere 7100, 7300, 1700, 1710, 1720; Kinze 2140, 3140 (mounts in front of bar) Kinze 3800 (mounts to side of hitch)		PPM726060	\$175.00
Universal Mount; fits 3 x 3 tube up to 9 x 10 tube		PPM726450	\$155.00
John Deere 7000, 7200, 1770, 1770NT, 1790 (mounts on cross bar of 3-point hitch)		PPM726515	\$300.00
Other compressor mounts are available or you can fabricate your own. Reference CleanSweep owners manual for more details.			

Cylinder Parts & Accessories		
Description	Product ID	Price
CleanSweep Air Cylinder	PPM755271	\$170.00
Air Cylinder Boot Kit	PPM755257	\$13.00
Elbow, CleanSweep Cylinder (2 per cylinder)	PPM755272	\$11.50
Spacer (2 per cylinder)	PPM755017	\$1.25
Pin, Cylinder Base	PPM755018	\$2.00
Pin, Cylinder Rod	PPM755019	\$1.00

Air Control Compressor/Controller Components		
Description	Product ID	Price
Compressor Air Filter	PPM726546	\$30.14
Compressor Tank Filter/Water Separator	PPM726744	\$50.00
Cleansweep Controller Only	PPM755277	\$595.00
Martin Manual Bidirectional Controller	MRT800887	\$726.00
Compressor Kit Only	PPM755279	\$1,350.00
Cleansweep Control Kit, W/O Compressor	PPM855055	\$690.00
Cleansweep Control Kit, With Compressor	PPM855025	\$1,945.00
Martin Control Kit, W/O Compressor	MRT858755	\$871.00
Martin Control Kit, With Compressor	MRT828755	\$2,126.00

Air Control Airline Kits		
Description	Product ID	Price
8-row, Air Line & Fittings Kit	PPM755035	\$205.00
12-row, Air Line & Fittings Kit	PPM755040	\$310.00
16-row, Air Line & Fittings Kit	PPM755085	\$415.00
24-row, Air Line & Fittings Kit	PPM755045	\$570.00
36-row, Air Line & Fittings Kit	PPM755050	\$810.00
48-row, Air Line & Fittings Kit	PPM755065	\$1,050.00
54-row, Air Line & Fittings Kit	PPM755070	\$1,200.00

# PRECISION PLANTING METER

**Improve Planter Performance Where it Counts - In the Meter!**

## A Better Finger Meter!

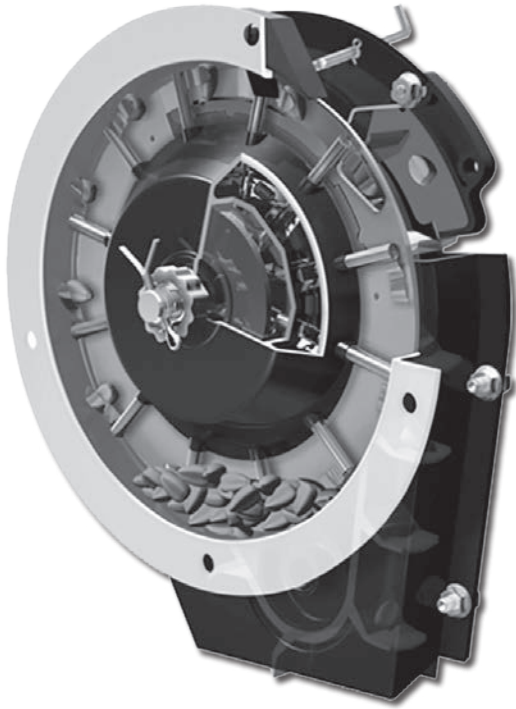

### Better Seed Spacing for More Harvestable Ears

At 65 rpm, precision matters. Springs, fingers, cams, backing plates, belts, housings, covers, brushes, bearings – everything must work together to get seed to the ground evenly spaced. In the Precision Meter, every part is precisely designed, engineered and manufactured to work together.

Compared to ordinary, less precise meters, this instantly produces more ears, 6+ bushels more, from every acre.

**When everything works together, every seed ends up where it belongs, producing picket fence stands, maximum yields and extra bushels for you.**

At 5 mph on 30-inch rows, your meter is turning at 65 rpm. At that speed, precision matters. Ordinary finger meters have a hard time singulating, especially with a wide variety of seeds. They'll miss one, then grab two, resulting in skips and doubles. That not only wastes seeds, it cuts your yield.

Because the components all mesh perfectly, Precision Meters hold one seed at a time, then release it. They're engineered and built to do it again and again. You'll see fewer skips and doubles – and higher yield.

### Precision Finger Set Complete Meter

John Deere 7000, 7100; Kinze 2000 series		
Description	Product ID	Price
Field Corn, 12-fingers, 30" or greater row spacing	PPM343022	\$233.00
Field Corn, 6-fingers, 15-20" row spacing	PPM343072	\$235.00
Sweetcorn, 12-fingers, 30" or greater row spacing	PPM343063	\$260.00
Popcorn, 12-fingers, 30" or greater row spacing	PPM343113	\$290.00
Pumpkin, 6-fingers	PPM343116	\$290.00
Sunflower, 12-fingers	PPM343110	\$310.00
John Deere 7200, 7300, 1700 series		
Description	Product ID	Price
Field Corn, 12-fingers, 30" or greater row spacing	PPM343025	\$233.00
Field Corn, 6-fingers, 15-20" row spacing	PPM343099	\$235.00
Sweetcorn, 12-fingers, 30" or greater row spacing	PPM343101	\$245.00
Popcorn, 12-fingers, 30" or greater row spacing	PPM343114	\$290.00
Pumpkin, 6-fingers	PPM343117	\$290.00
Sunflower, 12-fingers	PPM343111	\$310.00
Kinze 3000 series		
Description	Product ID	Price
Field Corn, 12-fingers, 30" or greater row spacing	PPM343030	\$233.00
Field Corn, 6-fingers, 15-20" row spacing	PPM343071	\$235.00
Sweetcorn, 12-fingers, 30" or greater row spacing	PPM343109	\$245.00
Popcorn, 12-fingers, 30" or greater row spacing	PPM343112	\$290.00
Pumpkin, 6-fingers	PPM343115	\$290.00
Sunflower, 12-fingers	PPM343105	\$310.00
Great Plains planters		
Description	Product ID	Price
Field Corn, 12-fingers, 30" or greater row spacing	PPM343050	\$230.00
Field Corn, 6-fingers, 15-20" row spacing	PPM343051	\$230.00
Sunflower, 12-fingers	PPM343055	\$290.00

### Precision Finger Set Meter & Universal Bullseye Seed Tube Kits Save \$9.50 per row

Make/Model	Description	Product ID	Price
John Deere 7000, 7100; Kinze 2000 series	Precision Meter (PPM343022) & Bullseye (PPM700150)	PPM345020	\$241.00
John Deere 7200, 7300, 1700 series	Precision Meter (PPM343025) & Bullseye (PPM700160)	PPM345021	\$241.00
Kinze 3000 series	Precision Meter (PPM343030) & Bullseye (PPM700150)	PPM345022	\$241.00

### Precision Finger Set Meter & Wave Vision Seed Tube Kits Save \$17.00 per row

Make/Model	Description	Product ID	Price
John Deere 7000, 7100; Kinze 2000 series	Precision Meter (PPM343022) & Wave Vision (PPM700250)	PPM345026	\$411.00
John Deere 7200, 7300, 1700 series	Precision Meter (PPM343025) & Wave Vision (PPM700200)	PPM345027	\$411.00
Kinze 3000 series	Precision Meter (PPM343030) & Wave Vision (PPM700250)	PPM345028	\$411.00

**Note:** For planters with Keeton Seed Firmers the new WaveVision firmer tail is required.

# PRECISION PLANTING METER PARTS

If you don't need a whole new meter, you can still improve your spacing with Precision Meter finger sets, backing plates or belts.

## Precision Finger Set

The shape and design of the finger determines how well it can singulate and hold a single seed – round or flat. The Precision Finger Set's unique finger shape locks both flat and round seeds under the flange for secure delivery to the seed belt.

Precision Finger Sets		
Description	Product ID	Price
Precision Finger set, 12-finger, corn	PPM343029	\$60.00
Precision Finger set, 6-finger, narrow row corn	PPM343053	\$62.00
Precision Finger set, 12-finger, sweetcorn	PPM343064	\$82.00
Precision Finger set, 6-finger, pumpkin	PPM343065	\$82.00
Precision Finger set, 12-finger, sunflower	PPM343067	\$160.00
Precision Finger set, 12-finger, popcorn	PPM343104	\$115.00

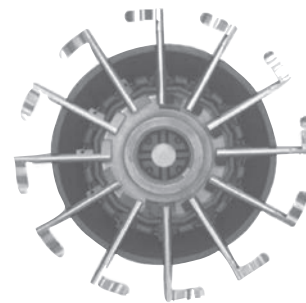

Precision Finger Set

## Precision Population Max Backing Plate

This special Kevlar® impregnated poly backing plate has big advantages over metal plates. It's flatter – eliminating the skips that occur as fingers rock and roll over the warped spots on stamped metal plates. It matches seed size – swap inserts and you can change the aggressiveness of the backing plate to match flats and rounds. The smaller exit hole reduces the chances that seeds can ricochet back into the meter.

Precision PopulationMax Backing Plate		
Description	Product ID	Price
Precision PopulationMax Backing Plate with "A" insert & adjustable brush	PPM342103	\$50.50
Precision PopulationMax Backing Plate with "C" insert & brushless blank	PPM342111	\$48.00
Replacement "A" Insert, most field corn and larger popcorn	PPM342110	\$7.00
Replacement "B" Insert, flat field corn with heavy seed treatment and small to medium popcorn	PPM342107	\$7.00
Replacement "C" Insert, sunflower, sweetcorn and edible beans	PPM342108	\$7.00



Population Max Backing Plate

## Precision Brushes

Set the brush toward the outside of the finger for large seeds so they don't dislodge. Set the brush further inside the finger for small seeds so it can aggressively remove doubles.

Precision Brushes		
Description	Product ID	Price
Precision Adjustable Brush	PPM343052	\$15.00
Pkg of 2, Precision Maroon Brush, Non-Adjustable, for Precision PopulationMax plate	PPM343049	\$5.50
T-Handle for Adjustable Brush	PPM343060	\$4.25



Adjustable Brush

## Precision SkipStop Cover

With its patented cushioning system, the SkipStop cover eliminates seed ricochets, which produce skips that you see in other finger pick-up meters. When seeds hit the cushion, they drop directly onto the seed belt for delivery to the seed tube. Includes cushion.

Precision SkipStop Cover		
Description	Product ID	Price
Precision SkipStop Cover, with cushion, all except Great Plains	PPM343024	\$28.00
Replacement SkipStop Cushion	PPM343014	\$20.00
Replacement SkipStop Cushion, Great Plains	PPM343073	\$17.00



SkipStop Cover

## Precision SureFire Seed Belt

The new SureFire™ cupped seed belt releases seed down the center every time for sure spacing and more ears.

Precision SureFire Seed Belt		
Description	Product ID	Price
Precision SureFire Seed Belt	PPM343066	\$20.00



SureFire Seed Belt

## Meter Re-Power Plus Kit

Includes: Precision Finger Set, Population Max Backing Plate with Adjustable Brush, Skipstop Cover, SureFire Seed Belt, Bullseye Seed Tube and T-Handle for Adjustable Brush.

Precision Re-Power Kits Save \$7.25 Per Row		
Description	Product ID	Price
Precision Re-Power Kit, John Deere 7000, 7100; Kinze with PPM700150 Bullseye	PPM345024	\$174.00
Precision Re-Power Kit, John Deere 7200, 7300, 1700 series with PPM700160 Bullseye	PPM345025	\$174.00



Re-Power Kit

Miscellaneous Service Parts		
Description	Product ID	Price
Drive Wheel for seed belt	PPM343062	\$7.50
Cover for Precision Meter, John Deere 7000, Kinze 2000	PPM343098	\$10.90
Ash Tray, finger holder	PPM343102	\$8.00

# PRECISION PLANTING eSET

## Every Seed, Every Time Simple Upgrade, Big Change in Your Stands

You want a picket fence stand that doesn't require a lot of headaches, but the adjustments you have to make on your meters are time consuming and don't give you the results you want.

The eSet meter is a retrofit system that goes inside of a John Deere vacuum meter and uses a flat disk without cells that are sensitive to seed size and shape, paired with a floating singulator that doesn't need adjustments. You simply set your vacuum, fill the planter with seed, and go. Whether you are running Pro Series row units or standard row hoppers, the eSet system will fit your planter.

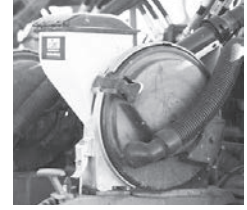

### Impeccable Singulation for John Deere Meters Without Adjustment



PPM720136

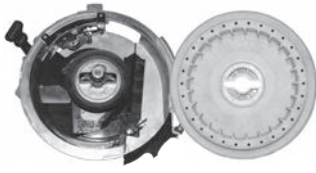

PPM720370

eSet Complete Kit		
Description	Product ID	Price
John Deere Mini Hopper Pro-Series eSet; ME Pro, Pro-Series XP, MaxEmerge5	PPM720136	\$150.00
John Deere Box Planter Standard eSet; MaxEmerge, MaxEmerge 2, MaxEmerge Plus MaxEmerge XP, MaxEmerge5	PPM720370	\$150.00

### eSet Pro Series; CCS Mini-Hopper

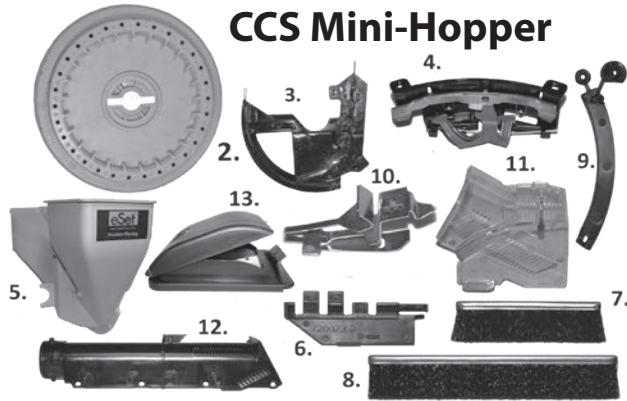

Precision Planting eSet Pro-Series Options		
Description	Product ID	Price
Step Kit, JD 1790 with 20" rows. Moves OEM steps out & away from ProFlo hoppers.	PPM720196	\$125.00
Package of 4, Elbow Kit, JD 1790 with 15" or 30" rows. Reroutes supply tube to ProFlo hopper on 4 center rows	PPM720206	\$35.00
Package of 4, Flap Kit, JD 1790 with 15" or 20" rows. Prevents seed from flowing out of hopper when folded. It is recommended to install flaps in all meters on every row.	PPM720244	\$15.00
Y-Tube Kit, DB 32-rows or more. One kit required for each row over 32	PPM720245	\$36.00
Package of 4, Stop Kit, JD 1790 with 15" split rows. Limits over-extension of parallel arms. Includes stop for 4 rows.	PPM720248	\$125.00

### eSet Standard; Box Planter

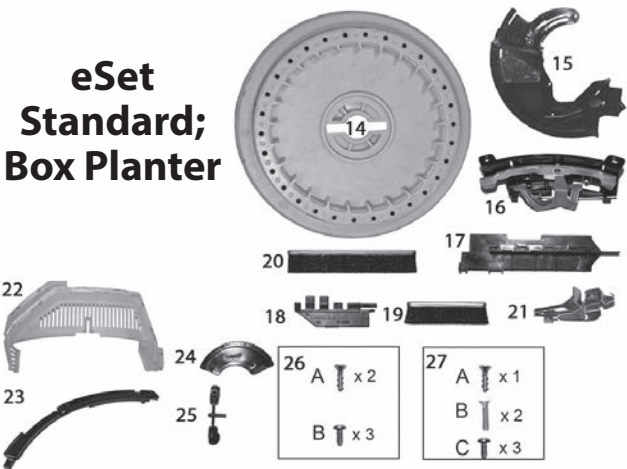

eSet Service Parts			Key	
Description	Product ID	Price	Pro-Series	Standard
Disk	PPM720003	\$50.00	2	14
Pro-Series Liner	PPM720251	\$8.25	3	n/a
Standard Liner	PPM720149	\$8.10	n/a	15
Singulator	PPM720372	\$60.00	4	16
Mini Hopper	PPM720209	\$19.00	5	n/a
Long Brush Holder	PPM720371	\$5.50	n/a	17
Short Brush Holder	PPM720023	\$2.75	6	18
Short Brush	PPM720384	\$6.00	7	19
Long Brush			8	20
Singulator Shim	PPM720067	\$1.30	9	n/a
Fragment Extractor	PPM720185	\$10.00	10	21
Pro-Series Vent	PPM720177	\$5.50	11	n/a
Standard Vent	PPM720235	\$6.00	n/a	22
Shim	PPM720374	\$5.50	n/a	23
D-Tube Assembly	PPM720270	\$10.00	12	n/a
Wedge	PPM720033	\$1.30	n/a	24
Vented Hopper Lid	PPM720225	\$9.00	13	n/a
T-Shaped Retainer	PPM720045	\$1.95	n/a	25
Hardware Kit (Standard) ME-ME XP	PPM720377	\$1.00	n/a	26
Hardware Kit (Standard) ME5	PPM720392	\$1.00	n/a	27

#### Other eSet Service Parts

Seed Deflector Kit, includes 4 liner springs and 4 screws.	PPM720268	\$4.00
Seed Deflector Tube, small crops	PPM720281	\$0.75
30" Vacuum Gauge with Filter	PPM730169	\$110.00

# eSET REPLACEMENT PARTS, Specific for Specialty Crops

S.I. Distributing offers eSet replacement parts, including seed discs, singulators and extractors for specialty crops. These crops include canola, chili, cotton, cucumbers, gourds, peanuts, popcorn, pumpkins, snap beans, sorghum, squash, sugar beets, sunflowers and sweet corn.



Cotton



PPM720285  
(Cotton)



Canola



PPM720301  
(Canola)

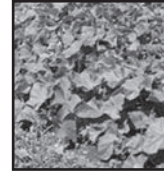

Cucumbers



PPM720284  
(Chili, Cucumber,  
Sugar Beet)

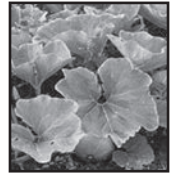

Pumpkins

Please see complete chart of the e-set meter setup by crop, including Singulator Position, Lower Brush Position, Deflector Position "Paperclip" and JD Wiper Used at [www.sidist.com/eset-meter-setup.pdf](http://www.sidist.com/eset-meter-setup.pdf)

## Precision Planting eSet Meter Setup by Crop

Crop	Size & Seeds/LB	Row Spacing	Vacuum Setting	Seed Disc Product ID	Seed Disc Price	Singulator	Singulator Price	Extractor	Extractor Price
Canola	60,000-100,000 seeds/lb	N/A	18"-20"	PPM720301	\$70.00	PPM720386	\$55.00	"PPM720295 Pro-Series"	\$30.00
								"PPM720305 Standard"	\$30.00
Chili	12 seeds/ft - 30" row	N/A	15"	PPM720284	\$70.00	PPM720386	\$55.00	PPM720117	\$10.00
Cotton	50,000-60,000 population	N/A	18"-20"	PPM720285	\$60.00	PPM720372	\$60.00	PPM720117	\$10.00
Cucumbers	N/A	N/A	10"	PPM720284	\$70.00	PPM720386	\$55.00	PPM720117	\$10.00
Field Corn	N/A	All	18"-20"	PPM720003	\$50.00	PPM720372	\$60.00	PPM720185	\$10.00
Gourds	N/A	N/A	10"	PPM729931	\$60.00	PPM720372	\$60.00	PPM720117	\$10.00
Peanuts	Medium (Spanish or Runner)	N/A	10"	JD H136092	-	N/A	-	N/A	N/A
Popcorn	Small	N/A	18"	PPM729931	\$60.00	PPM720372	\$60.00	PPM720117	\$10.00
	Medium	N/A	18"	PPM729932	\$60.00	PPM720372	\$60.00	PPM720117	\$10.00
	Large	N/A	18"	PPM729933	\$60.00	PPM720372	\$60.00	PPM720117	\$10.00
Pumpkins	Del Monte/Libby	60"	13"	PPM729931	\$60.00	PPM720372	\$60.00	PPM720117	\$10.00
	Ornamental	60"	14"	PPM729932	\$60.00	PPM720372	\$60.00	PPM720117	\$10.00
Snap Beans	100,000 Population / 30" rows	N/A	18"-20"	PPM720286	\$60.00	PPM720386	\$55.00	PPM720117	\$10.00
Sorghum	13,000-16,000 seeds/lb	N/A	11"-12"	PPM720282	\$70.00	PPM720372	\$60.00	PPM720117	\$10.00
	Population: 40,000 Non-Irrigated	N/A	11"-12"	PPM720282	\$70.00	PPM720372	\$60.00	PPM720117	\$10.00
	Population: 80,000 Irrigated	N/A	11"-12"	PPM720282	\$70.00	PPM720372	\$60.00	PPM720117	\$10.00
Soybeans	N/A	N/A	15"-20"	PPM720286	\$60.00	PPM720386	\$55.00	PPM720117	\$10.00
	N/A	N/A	30"	JD A42586	-	N/A	-	N/A	N/A
Squash	N/A	N/A	15"	PPM729932	\$60.00	PPM720372	\$60.00	PPM720117	\$10.00
Sugar Beets	15,000-18,000 seeds/lb	N/A	18"	PPM720284	\$70.00	PPM720386	\$55.00	PPM720117	\$10.00
	13,000-15,000 seeds/lb	N/A	20"	PPM720282	\$70.00	PPM720386	\$55.00	PPM720117	\$10.00
Sunflowers	Confectionary/ Edible	30"	12"	PPM720003	\$50.00	PPM720372	\$60.00	PPM720185	\$10.00
	#1	30"	13"-14"	PPM729932	\$60.00	PPM720372	\$60.00	PPM720117	\$10.00
	#2	30"	12"-13"	PPM729932	\$60.00	PPM720372	\$60.00	PPM720117	\$10.00
	#3, #4	30"	7"-8"	PPM729931	\$60.00	PPM720372	\$60.00	PPM720117	\$10.00
Sweet Corn	Small	30"	15"-18"	PPM729932	\$60.00	PPM720386	\$55.00	PPM720117	\$10.00
	Medium	30"	15"-18"	PPM729933	\$60.00	PPM720386	\$55.00	PPM720117	\$10.00
	Large	30"	15"-18"	PPM729934	\$60.00	PPM720386	\$55.00	PPM720117	\$10.00



PPM729931  
(Gourds, Small  
Popcorn, Del  
Monte/Libby  
Pumpkins)



PPM729932  
(Ornamental  
Pumpkins)



PPM720003  
(Field Corn,  
Sunflower)



PPM729933  
(Large Popcorn,  
Med Sweet Corn)



PPM720386  
Singulator



PPM720117  
Extractor

eFlow Lubricant - PPM930004: Use on all seeds at 1/8 - 1/4 cup per bag of seed depending on seed size. Do not over apply.

# AIR DESIGN SCRAPERS

## Planter Tungsten Carbide Scraper Kits

Case-IH	Description		Product ID	Price
800, 900	Outside	2-piece design, includes scrapers. Reuse OEM mounting arms and rivets.	ADC210560	\$33.95
800, 900, 1200, 5400SS, 5500SS	Outside	2-piece design, includes scrapers and reusable mounting arms.	ADC210570	\$45.95
2000	Outside	2-piece design, includes scrapers and reusable mounting arms.	ADC210590	\$49.95
800, 900, 1200	Inside	Includes scrapers.	ADC210580	\$39.95
Kinze	Description		Product ID	Price
2000, 3000	Outside	2-piece bolt-on design, includes scrapers & reusable mounting arms. Compatible with scraper mounted Keeton seed firmer brackets.	ADC210490	\$42.95
2000, 3000	Outside	2-piece design, includes scrapers, reusable mounting arms, & spring.	ADC210500	\$45.95
4000	Outside	2-piece design, includes scrapers, reusable mounting arms, & spring.	ADC210480	\$45.95
2000, 3000	Inside	Includes scrapers, mounting brackets, spring & hardware.	ADC210690	\$37.95
3000	Inside	Includes scraper & hardware.	ADC210470	\$29.95
John Deere	Description		Product ID	Price
MaxEmerge (7000, 7100)	Outside	2-piece design, includes scrapers, reusable mounting arms, & spring.	ADC210500	\$45.95
MaxEmerge 2, MaxEmerge Plus, MaxEmerge XP, MaxEmerge 5	Outside	2-piece design, includes scrapers. Reuse OEM mounting arms & spring.	ADC210510	\$31.49
MaxEmerge 2, MaxEmerge Plus, MaxEmerge XP, MaxEmerge 5	Outside	1-piece design, includes scraper/arm assemblies & spring.	ADC220880	\$44.95
MaxEmerge 5, ExactEmerge	Outside	1-piece design, includes scraper/arm assemblies, spring clamps & mounting bolts.	ADC220890	\$52.95
MaxEmerge (7000, 7100)	Inside	Includes scrapers, mounting brackets, spring & hardware.	ADC210690	\$37.95
MaxEmerge 2, MaxEmerge Plus	Inside	Includes scrapers, mounting bracket, spring & hardware.	ADC210700	\$37.95
MaxEmerge XP	Inside	Includes scrapers, mounting brackets, spring & hardware.	ADC210740	\$37.95
White/MF/Fendt	Description		Product ID	Price
5000, 6000, 8000	Outside	2-piece design, includes scrapers, adapter plates & shims. Reuse OEM mounting arms.	ADC210530	\$37.95
9000, Momentum FTPM	Outside	2-piece design, includes scrapers & reusable mounting arms.	ADC210540	\$45.95

## Drill/Seeder Tungsten Carbide Scraper Kits

Case-IH / New Holland	Description		Product ID	Price
500, P2080, P2085	Outside	Includes RH scraper assembly & hardware.	ADC210821	\$47.95
		Includes LH scraper assembly & hardware.	ADC210822	\$47.95
620, 6000	Inside	Includes scrapers, spring, & hardware.	ADC700000	\$29.95
5000, 6000, 8000	Inside	Includes scrapers, spring, & hardware.	ADC710000	\$33.95
5400, 5500	Inside	Left leading disc. Includes scrapers, spring & hardware.	ADC700200	\$35.95
		Right leading disc. Includes scrapers, spring & hardware.	ADC700300	\$35.95
SDX	Outside	Includes RH scraper assembly & hardware.	ADC210801	\$47.95
		Includes LH scraper assembly & hardware.	ADC210802	\$47.95
Great Plains	Description		Product ID	Price
00HD series	Outside	Includes scrapers, mounting bracket & hardware.	ADC210950	\$37.95
00, 06, 07, 10 series	Inside	Includes scrapers, mounting bracket & hardware.	ADC210300	\$37.95
Yield Pro	Outside	Includes scrapers, mounting & mounting arms	ADC210310	\$49.95
John Deere	Description		Product ID	Price
455, 730, 1060, 8300, 9350	Inside	Includes scrapers, spring, & hardware.	ADC800000	\$29.95
1590, 1890, 1895, 1990	Gauge Wheel Side	Includes RH scraper assembly & bracket.	ADC210601	\$47.95
		Includes LH scraper assembly & bracket.	ADC210602	\$47.95
1590, 1890, 1895, 1990	Seed Boot Side	Includes RH scraper assembly & bracket.	ADC210631	\$47.95
		Includes LH scraper assembly & bracket.	ADC210632	\$47.95

The Tungsten Carbide scrapers feature an extremely simple design with a **special tungsten carbide edge**. The tungsten carbide provides outstanding abrasion resistance along with toughness to give superior, long-lasting performance and reduces the need for replacement.

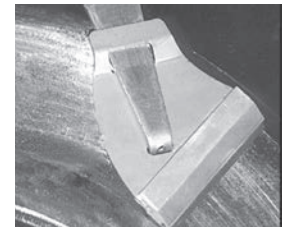

Save time, labor and money. **The Tungsten Carbide scraper will outlast and outwear standard cast scrapers** and they can't flip over and fall off. The scraper features a special tungsten carbide cutting edge.

# SEED TUBES

**Better information in. Better information out.**

For measuring population, seed spacing, skips and doubles, you depend on the accuracy of your seed sensors. But optical sensors have four big problems:

- Dust looks just like seeds
- Doubles look like singles
- Dust coats the eyes
- Sensor mounts in middle of seed tube



COUNT JUST THE SEED      NOT DUST AND DEBRIS

## WaveVision

### WaveVision Advantages:

- Uses high frequency radio waves
- Sensors see 3-dimensional mass, not shapes
- Can distinguish doubles
- Sensors see through dust for more accuracy
- Sensor mounts at bottom of seed tube



- Not compatible with these monitors: AGCO GTA, SM400SE, Kinze® Vision, KPM I, II, III, Monosem MPM, SM3000.

Seed Tubes						
Make	Model	Seed Tube Opening	Bullseye	Price	WaveVision	Price
Case-IH	1200 Series (2009+ & vSet only)	3" x 2"	Not Available		PPM700269	\$205.00
Great Plains	Yield Pro Planters	2-1/4" x 1-1/2"	PPM700150	\$18.00	PPM700250	\$195.00
John Deere	7000, 7100 series	2-1/4" x 1-1/2"	PPM700150	\$18.00	PPM700250	\$195.00
John Deere	7200, 7300 series	2-1/4" x 1-1/2"	PPM700150	\$18.00	PPM700250	\$195.00
John Deere	7200, 7300 series	3" x 2-1/4"	PPM700160	\$18.00	PPM700200	\$195.00
John Deere	1700 series including MaxEmerge 5	3" x 2-1/4"	PPM700160	\$18.00	PPM700200	\$195.00
Kinze	2000 Series	2-1/4" x 1-1/2"	PPM700150	\$18.00	PPM700250	\$195.00
Kinze	3000 Series	2-1/4" x 1-1/2"	PPM700150	\$18.00	PPM700250	\$195.00
Kinze	3000 Series	3" x 2-1/4"	PPM700160	\$18.00	PPM700200	\$195.00
Monosem	All	2-1/4" x 1-1/2"	PPM700158	\$18.00	PPM700290	\$195.00
White	5000, 6000, 8000, 9000 series	2-1/4" x 1-1/2"	PPM700155	\$18.00	PPM700255	\$195.00

**Bullseye Seed Tubes accept 1/2" and 3/4" diameter sensors**

## Bullseye Seed Tubes



### Bullseye Advantages:

- Reduces seed tube bounce
- Reduces excessive wear
- Long life with the tungsten-carbide tip
- Smooth path to the trench

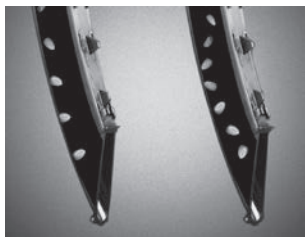

No Sensor Interference      Sensor Interference



Offset Sensor to Reduce Seed Catchpoints

### Redesigned Tip for Less Wear

- Bullseye (left)
- Conventional (right)



Seed Tube Mounting Accessories			
Product ID	Description		Price
PPM700279	Pin & clip for John Deere ME2 and ME+ row units with steel shank. For Bullseye seed tubes on planters with mounting holes in shank. Pin is 1/4" x 2-5/8" long.		\$1.50
PPM700167	Pkg of 4, spring pin for John Deere XP and newer row units with cast shank. For Bullseye seed tubes on planters without mounting holes in shank		\$12.00
PPM700266	WaveVision Power Module for Planters without 2020 SeedSense		\$495.00

**Achieves 30-40% Longer Wear than Competing Openers!**

**Improved life with sharp cutting-edge retention due to high hardness.**

Created with high-grade, quality boron steel, this opener fits nearly all brands of planter and drill applications and is protected with a lifetime warranty on breakage.

- Better blade to soil contact
- Blades do not roll over or break in rocky soils

### 3 ZONES OF HARDNESS

- 1 Increased Flexibility**  
(49-50 HRC)
- 2 Increased Durability**  
(50-55 HRC)
- 3 Maximum Wear**  
(55-58 HRC)

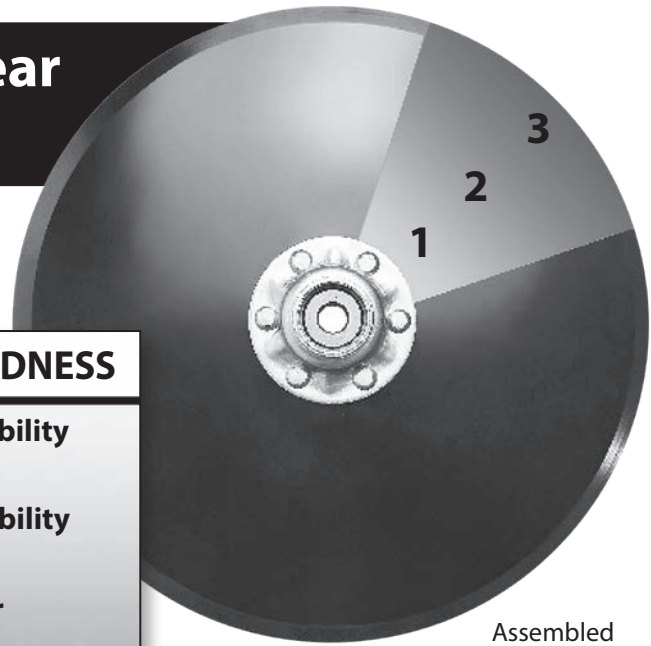

Assembled in the USA



- Patented 3-stage induction heat-treating process for a harder edge
- Retains a sharp cutting edge to ensure accurate seed placement
- Excellent resistance to breakage
- Lifetime warranty on breakage

### WearParts Seed Disc Openers

AGCO	Diameter	Thickness	Bearing	Product ID	Vendor ID	Price/Ea
White 5000 series	13"	3mm	Single 204	WPT013577	700164109#	\$49.95
White 6000, 8000 series	15"	3.5mm	Single 204	WPT015037	AA53860BA#	\$54.72
White/Massey 9000 series, Momentum, Precision Planting (Xtreme Duty) cast hub	15.8"	3.5mm	Double 204	WPT015088	700172776#	\$82.48
Case-IH	Diameter	Thickness	Bearing	Product ID	Vendor ID	Price/Ea
800, 900, 1200 series planters 5400, 5500 Soybean Special drills 5/8" x 2" bolt required (Xtreme Duty) low profile cast hub	14" Lead	3.5mm	KRP51	WPT014033	90324905XDLPZ#	\$82.31
	14" Trail			WPT014533	90324957XDLPZ#	
2100 series; (Xtreme Duty) low profile cast hub	14" Lead	4.5mm	KRP51	WPT014051	90325367XDLPZ#	\$83.66
	14" Trail			WPT014551	90325368XDLPZ#	
	15"	4.5mm	KRP51	WPT015024	51691765XDLPZ#	\$86.63
Great Plains	Diameter	Thickness	Bearing	Product ID	Vendor ID	Price/Ea
Yield Pro Planters, HD Drills 1999 & Newer	15"	4mm	Double 205	WPT015022	404-121SBA#	\$72.28
Harvest International	Diameter	Thickness	Bearing	Product ID	Vendor ID	Price/Ea
Laser Pro 1	15"	3.5mm	Double 205	WPT015063	AA65248HDBA#	\$69.95
John Deere	Diameter	Thickness	Bearing	Product ID	Vendor ID	Price/Ea
MaxEmerge, MaxEmerge2, Plus, Pro	15"	3.5mm	Single 204	WPT015037	AA53860BA#	\$54.72
XP, XP Pro, ME5, ExactEmerge (Standard duty)	15"	3.5mm	Double 204	WPT015021	AA65248MDBA#	\$64.95
XP, XP Pro, ME5, ExactEmerge (Heavy duty)	15"	3.5mm	Double 205	WPT015063	AA65248HDBA#	\$69.95
XP, XP Pro, ME5, ExactEmerge (Xtreme Duty) cast hub	15"	3.5mm	KRP51	WPT015077	AA65248XDBA#	\$75.89
Kinze	Diameter	Thickness	Bearing	Product ID	Vendor ID	Price/Ea
2000, 3000, 4000, 5000 series	15"	3.5mm	Single 204	WPT015037	AA53860BA#	\$54.72
3000, 4000, 5000 series (Heavy Duty Bearing) stamped hub w/oversized rivets; 1-3/4" bolt required	15"	3.5mm	Double 204	WPT015021	AA65248MDBA#	\$64.95
3000, 4000, 5000 series (Heavy Duty Bearing & Hub) stamped hub w/oversized rivets; 1-3/4" bolt required	15"	3.5mm	Double 205	WPT015063	AA65248HDBA#	\$69.95
3000, 4000, 5000 series (Xtreme Duty) cast hub; 1-3/4" bolt required	15"	3.5mm	KRP51	WPT015077	AA65248XDBA#	\$75.89

### Wearparts Hardware Kit

Model	Product ID	Description	Price
Kinze 3000, 4000, 5000 series	HDW220049	HHCS, 5/8-11 X 1-3/4, Includes Left and Right Hand Threaded Bolts	\$8.00

# PTT OPENER BLADES



**Revolutionary planter blades capable of running in challenging soils, residues and climate condition**

**Optimal seeding conditions** is achieved with this agronomic geometric tooth design through:

- The rotation and cutting action
- Decreased sidewall and furrow compaction
- Ability to granulate moist soil into the furrow by increased soil flow, achieving maximum soil-to-seed contact

If the following conditions are present, use

## STP (“Sabre Tooth Planter”)

## STPF (“Sabre Tooth Planter Fine”)

- 18 CEC to 40 CEC
- Conditions with few rocks
- Minimum planting depth of 1”
- Planting speeds up to 8 MPH
- Green planting conditions/cover crops, stripper stubble, no-till, and fall tillage (minimum tillage applicable with management)

## Features:

- Billet 1045 steel hub for ultimate strength, heat dissipation, and quality
- 52-54 blade Rockwell hardness
- Double Roller Taper Bearing option for extreme down pressures & adverse planting conditions.



If the following conditions are present, use

## STPS (“Sabre Tooth Planter Shallow”):

- Consistently 18 CEC or less. (STPF applicable with management)
- Sharp gravel, shale, or very rocky conditions.
- Planting depths of 1” or less
- High planting speeds 8 MPH & up
- Conventional tillage (STPF applicable with management)

### Standard Single & Double Roller Bearing Openers

Case-IH	STPF		STPS		Price
	LH Lead Row Units	RH Lead Row Units	LH Lead Row Units	RH Lead Row Units	
800, 900 1200 (1-3/4" bolt required, HDW220049)	PTT101042	PTT201042	PTT101022	PTT201022	\$170.00
AGCO/Precision Planting		Left Half of Planter	Right Half of Planter	All Rows	Price
6000 (1-3/4" bolts required, HDW220049)	PTT102012	PTT202012	PTT003022	PTT003022	\$170.00
8000 (45mm bolts required, HDW220048)	PTT102012	PTT202012	PTT004022	PTT004022	\$170.00
9000, Precision Ready	PTT104012	PTT204012	PTT003021	PTT003021	\$170.00
John Deere		Left Half of Planter	Right Half of Planter	All Rows	Price
MaxEmerge, ME 2, ME Plus, Pro-Series (single roller bearing)	PTT102011	PTT202011	PTT003022	PTT003022	\$170.00
XP, Pro-Series XP, ME5, ExactEmerge	PTT102012	PTT202012	PTT003021	PTT003021	\$170.00
Kinze		Left Half of Planter	Right Half of Planter	All Rows	Price
2000 (single roller bearing)	PTT102011	PTT202011	PTT003022	PTT003022	\$170.00
3000, 4000 (1-3/4" bolts required, HDW220049)	PTT102012	PTT202012	PTT003021	PTT003021	\$170.00
5000	PTT102012	PTT202012	PTT003022	PTT003022	\$170.00

### Heavy Duty Double Roller Taper Bearing Openers

Case-IH	STPF		STPS		Price
	LH Lead Row Units	RH Lead Row Units	LH Lead Row Units	RH Lead Row Units	
2000 (requires stud kit, HDW220079)	PTT103043	PTT203043	PTT103023	PTT203023	\$211.00
John Deere		Left Half of Planter	Right Half of Planter	All Rows	Price
XP, Pro-Series XP, ME5, ExactEmerge (requires stud kit, HDW220079)	PTT102013	PTT202013	PTT003023	PTT003023	\$211.00
Kinze		Left Half of Planter	Right Half of Planter	All Rows	Price
3000, 4000, 5000 (requires stud kit, HDW220081)	PTT102013	PTT202013	PTT003023	PTT003023	\$211.00

### PTT Opener Blade Hardware Kits

Bolt Kits	Product ID	Price/Kit	Stud Kits	Product ID	Price/Kit
5/8-11 X 1-1/4, LH & RH bolts kit	HDW220047	\$13.35	M16-2 X 57, LH & RH studs kit	HDW220079	\$13.00
M16-1.5 X 45, LH & RH bolts kit	HDW220048	\$6.95	M16-2 X 57, LH & RH studs & nuts kit	HDW220080	\$16.00
5/8-11 X 1-3/4, LH & RH bolts kit	HDW220049	\$8.00	5/8-11 X 2.25, LH & RH studs & nuts kit	HDW220081	\$16.00

# VALION SEED TUBE GUARDS

Valion seed tube guards will eliminate seed tube wear and greatly reduce blade flex to create a properly shaped furrow and improved planting depth control. These guards are perfect for no-till or high-wear conditions, or anyone who is simply tired of replacing seed tube guards so often.

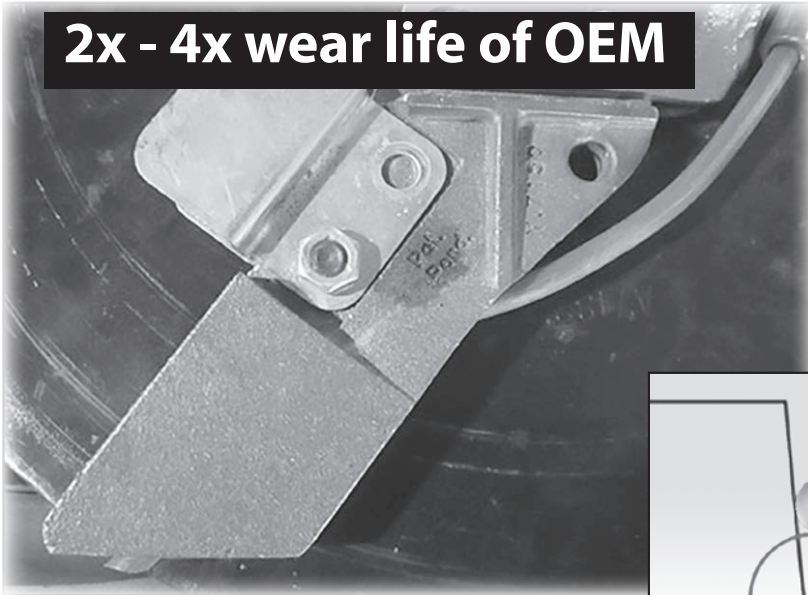

**2x - 4x wear life of OEM**

While intended to limit blade flex, standard OEM seed tube guards can wear substantially in just a few hours of use.

These chrome Valions will outlast OEM guards by 2 to 4 times, so that furrows are properly shaped and seeds placed at the correct depth continuously down the row, and all the way through the planting season.

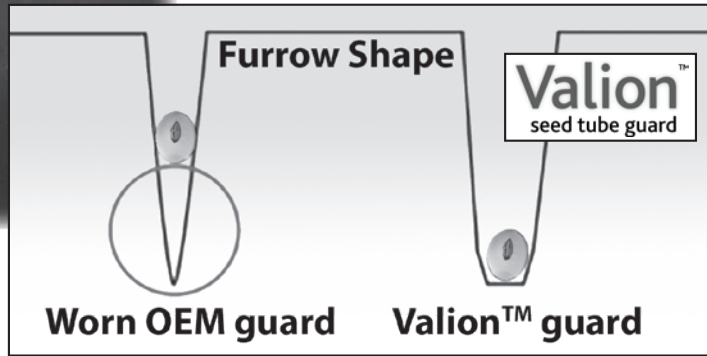

- Prevent blade flex
- Avoid pinched furrows
- Get consistent seed depth
- Doesn't drag below blades

## Valions

Make	Model	Valions w/o fertilizer	Price	Valions w/ fertilizer	Price
John Deere	MaxEmerge 7000, 7100	EXP100150	\$54.00	EXP200150	\$87.23
John Deere	MaxEmerge 7000, 7100 with oversize rivets	EXP100153	\$54.00	EXP200153	\$87.23
John Deere	MaxEmerge 2, Plus, Pro	EXP100150	\$54.00	EXP201150	\$87.23
John Deere	MaxEmerge 2, Plus, Pro with oversize rivets	EXP100153	\$54.00	EXP201153	\$87.23
John Deere	XP, XP Pro, MaxEmerge 5	EXP100450	\$56.00	EXP200450	\$90.53
Kinze	2000 series	EXP100150	\$54.00	EXP200150	\$87.23
Kinze	2000 series with oversize rivets	EXP100153	\$54.00	EXP200153	\$87.23
Kinze	3000 series	EXP100350	\$36.00	Not available	
Kinze	4000, 5000 series	EXP100500	\$55.00	Not available	



**Liquid Capability Valions** are also a slick way to apply liquids into the seed furrow. Here's how to make this setup as trouble-free as possible and more

- Affordable and durable than competitor systems stainless steel liquid tube holders
- No drilling - installs with existing bolt holes
- Secures plastic 1/4" line for liquids
- Keeps the tubing away from the blades
- Prevents damage from stalks or tree limbs
- Stainless steel for low corrosion
- Thick-wall pipe



Valion Liquid Components		
Product ID	Product Description	Price
EXP100133	Tube holder, JD MaxEmerge 7000, 7100; Kinze 2000	\$25.00
EXP100433	Tube holder, JD MaxEmerge 2, Plus, Pro	\$25.00
EXP100454	Tube holder, JD XP, ME5	\$26.30
EXP111228	Tubing, 1/4"x28"	\$8.23



# ACRA-PLANT V-Shots and V-Slices

- Standard V-Shot is 3/8" below seed disc
- Short V-Shot is 1/8" below seed disc

Optional Seed Tube Clip		
Product ID	Description	Price/Each
JDP100005	Seed tube clip	\$8.95

Optional seed tube clip NOT included with V-Slice. Included with V-Shot.

- **Acra-Tuff chrome carbide for long wear life**

Acra-Plant		V-Slice		V-Shot		Short V-Shot	
Make	Model	V-Slice w/o fertilizer	Price	Standard V-Shot w/ fertilizer	Price	Short V-Shot w/ Fertilizer	Price
Case-IH	800, 900 series, 1200 series	APL009885	\$45.95	APL909885	\$139.00		
John Deere	MaxEmerge 7000, 7100 Before 1984	APL001785	\$45.95	APL911785	\$139.00		
John Deere	MaxEmerge 7000, 7100 1984-1986	APL001785	\$45.95	APL921785	\$139.00		
John Deere	MaxEmerge 2, Plus, Pro	APL001785	\$45.95	APL901785	\$139.00		
John Deere	XP, XP Pro, MaxEmerge 5	APL201985	\$45.95			APL081985	\$139.00
Kinze	2000 series	APL001785	\$45.95	APL911785	\$139.00		
Kinze	3000 series	APL001885	\$45.95	APL901885	\$139.00	APL081885	\$139.00
Kinze	4900 series			APL904985	\$139.00		
White	6000, 8000 series	APL001685	\$45.95	APL901685	\$139.00		
White	9000 series			APL901690	\$139.00		

Note: Will NOT work with Totally Tubular  
Seed tube clip NOT included



**Apply starter fertilizer where it belongs, below and beside the seed.**

## RK PRODUCTS SEED TUBE GUARDS

RK seed tube guards are made from hardened, heat-treated steel, which lasts significantly longer than many OEM guards that are often made from softer metals. RK guards are engineered to precise dimensions, preventing the discs from flexing inward, which can distort the trench and affect seed placement. They won't bend or distort like OEM versions. RK guards retain their shape — even in abrasive no-till or high-residue conditions. Designed to shield the seed tube from disc blade wear.

RK Products Seed Tube Guard			
John Deere	Vendor ID	Product ID	Price
MaxEmerge 7000, 7100	PR5145	CPH005145	\$104.00
MaxEmerge 7000, 7100 with oversize rivets	PR5146	CPH005146	\$104.00
XP, Pro-Series XP, MaxEmerge 5	PR5153	CPH005153	\$104.00
Kinze	Vendor ID	Product ID	Price
2000 series	PR5145	CPH005145	\$104.00
2000 series with oversize rivets	PR5146	CPH005146	\$104.00
White	Vendor ID	Product ID	Price
6000, 8000 series	PR5233	CPH005233	\$104.00
9000 series 1.0 row unit	PR5236	CPH005236	\$104.00
Liquid Components	Vendor ID	Product ID	Price
Extended Fertilizer Tube Assembly, Fits CPH005153	PR5501	CPH005501	\$66.00
Fertilizer Tube Assembly, Fits all other RK Products seed tube guards	PR5500	CPH005500	\$27.00



CPH005153



CPH005146



CPH005233

# OTICO FARMFLEX GAUGE WHEEL ASSEMBLIES

Otico FARMFLEX® Gauge Wheels are the industry leaders in agronomic performance and wear resistance. Their wheel technology and rim & bearing design is unmatched for strength and efficiency.



Spoked Gauge Wheel Assembly



Solid Gauge Wheel Assembly

- 16" diameter x 3" or 4.5" width
- Fits most makes and models



## The FARMFLEX® Concept

The FARMFLEX® concept is based on the use of semi-hollow tires, which makes Otico products especially effective, regardless of the conditions in which they operate.



### SELF-CLEANING

Specific rubber formulations and wheel shapes facilitate self-cleaning.

### SHOCK ABSORPTION

Rubber shock absorption means more consistent sowing and depth control. Rims and bearings last longer due to better shock absorption.

### QUALITY

Very high quality rubber specially designed to meet increasing demands for longevity.

Otico Gauge Wheel Assemblies					
5/8"/16mm bearing, Reduced Inner Diameter		Style	Description	Product ID	Price
Case-IH: 1200, 2000	Spoked	4.5 X 16, 5/8"	OTC860474	\$160.00	
	Solid	4.5 X 16, 5/8"	OTC876047	\$112.00	
	Tire Only	4.5 X 16	OTC087604	\$62.00	
5/8"/16mm bearing, Standard Profile		Style	Description	Product ID	Price
Case-IH: 500, 500T Great Plains: YP Series; 15, 25 series with 15" openers John Deere: 1700/DB with XP, ME5, EE; 750, 1560, 1590, 1850, 1860, 1890, 1895, 1990 Kinze: 2000 '93 & after, 3000, 4000, 5000 Monosem: Plus Series New Holland: P2080, P2085 White: 8000, 9000	Spoked	4.5 X 16, 5/8"	OTC888055	\$145.00	
		3 X 16, 5/8"	OTC898188	\$145.00	
	Solid	4.5 X 16, 5/8"	OTC866605	\$104.00	
		3 X 16, 5/8"	OTC866988	\$119.00	
	Tire Only	4.5 X 16	OTC084062	\$60.83	
		4.5 X 16	OTC084050	\$60.83	
		3 X 16	OTC098188	\$39.00	

Assemblies will fit older Deere planters that have upgraded to 5/8"/16mm bolt on gauge wheel arms

## SET-N-SEED PLANTER DEPTH CALIBRATION TOOL

### Eliminate Variances in Planter Row Unit Depth

Accurately and quickly set the desired depth, across your planter, from 1" to 2.5" using a main block and multiple stackable inserts.

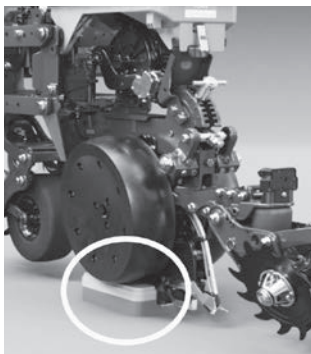

**Keep It Calibrated:** Planter depth can vary across the planter depending on the wear of the planter unit. Disk openers, gauge wheel arms, and rocker arms are just a few of the vital parts that determine your seed's depth.

To use the Set-N-Seed, start by placing it on a floor jack and setting the inserts to your desired depth. Then you will want to set your depth setting on the planter to the deepest setting. You will then raise the jack up under the row until the disc openers bottom out on the metal plate. Adjust your planter depth arm to bottom out on the gauge wheel arm and you're done.

Product ID	Description	Price/Ea
SNS009001	Set-N-Seed	\$185.00
Shallow Planting Accessories		
SNS009006	Stackables, Pair, 1/4"	\$15.00
SNS009005	Planting Depth Adapter, 1/2"	\$15.00
Replacement Parts		
SNS009003	Stackables, Pair, 1/2"	\$15.00



20-Second Process of Setting Each Row Unit to Your Desired Depth

# MUDSMITH GAUGE WHEELS

**Greatly Improve Planting Efficiency During Wet Soil Conditions!**

## Get in the Field Sooner with MudSmith Gauge Wheels

These wheels are crafted with a patented open rim design, to reduce mud and debris build-up, that allows you to get in your fields early, regardless of moisture levels.

**3 Spoke Open Rim Design:** Reduces wheel plugging that causes delays, repairs and stress.

**Modular Design:** The modular design allows every part to be field replaceable.

**Single Piece Cast Hub:** Keeps wheel stable - extending bearing life, and cuts down on time spent changing bearings, in one complete, durable housing.

**HD Rubber:** Thicker rubber lasts 20% longer.



**Spoked Wheel**  
Sizes: 4.5", 3", 2.5"  
\$165.00



**Spoked Hardware Kit**  
Sizes: 4.5", 3", 2.5"  
\$140.00



**Solid Wheel**  
Sizes: 4.5", 3"  
\$105.00

## GAUGE WHEELS REINVENTED

MudSmith Gauge Wheel Assemblies						MudSmith Components			
5/8" or 16mm Bearing	Style	Tire Profile	Size	Product ID	Price/Ea	Tire Only	Price/Ea	Hub/Bearing	Price/Ea
<b>Case-IH:</b> 1200, 2000	Spoked Gauge Wheel	RID Tire	4.5" x 16"	MSW653450	\$165.00	MSW446000	\$60.00	MSW260000	\$65.00
		<i>Reduced Inner Diameter</i>	3" x 16"	MSW810300	\$165.00	MSW333000	\$60.00		
		Gauge Wheel Hardware Kit <i>Wheel Assembly Only, No Tire</i>	4.5" x 16"	MSW613000	\$140.00	-	-		
			3" x 16"	MSW810000	\$140.00	-	-		
<b>Case-IH:</b> 500, 500T <b>Great Plains:</b> YP Series; 15, 25 series with 15" openers <b>John Deere:</b> 1700/DB with XP, ME5, EE; 750, 1560, 1590, 1850, 1860, 1890, 1895, 1990 <b>Kinze:</b> 2000 '93 & after, 3000, 4000 <b>Monosem:</b> Plus Series <b>New Holland:</b> P2080, P2085 <b>White:</b> 8000, 9000	Spoked Gauge Wheel	Standard Profile Tire	4.5" x 16"	MSW630450	\$165.00	MSW445000	\$55.00	MSW260000	\$65.00
			3" x 16"	MSW850300	\$165.00	MSW331000	\$55.00		
		Twin Row Tire	2.5" x 16"	MSW750250	\$165.00	MSW250000	\$55.00		
		RID Tire <i>Reduced Inner Diameter</i>	4.5" x 16"	MSW630451	\$165.00	MSW446000	\$60.00		
			3" x 16"	MSW850301	\$165.00	MSW333000	\$60.00		
		Gauge Wheel Hardware Kit <i>Wheel Assembly Only, No Tire</i>	4.5" x 16"	MSW630000	\$140.00	-	-		
	3" x 16"		MSW850000	\$140.00	-	-			
	HD Solid Wheel	Standard Profile Tire	4.5" x 16"	MSW620000	\$105.00	MSW445000	\$55.00		
			3" x 16"	MSW840300	\$105.00	MSW331000	\$55.00		
	<b>Set Screw Bearing</b>	<b>Style</b>	<b>Tire Profile</b>	<b>Size</b>	<b>Product ID</b>	<b>Price/Ea</b>	<b>Tire Only</b>		
<b>John Deere:</b> late 7200, late 7300, early 1700, early 1530, early 1535, <b>White:</b> 6000	Spoked Gauge Wheel	Standard Profile Tire	4.5" x 16"	MSW530450	\$165.00	MSW445000	\$55.00	MSW200000	\$65.00
			3" x 16"	MSW830300	\$165.00	MSW331000	\$55.00		
		RID Tire <i>Reduced Inner Diameter</i>	4.5" x 16"	MSW530451	\$165.00	MSW446000	\$60.00		
			3" x 16"	MSW830301	\$165.00	MSW333000	\$60.00		
		Gauge Wheel Hardware Kit <i>Wheel Assembly Only, No Tire</i>	4.5" x 16"	MSW530000	\$140.00	-	-		
3" x 16"	MSW830000		\$140.00	-	-				
<b>Roll Pin Bearing</b>	<b>Style</b>	<b>Tire Profile</b>	<b>Size</b>	<b>Product ID</b>	<b>Price/Ea</b>	<b>Tire Only</b>	<b>Price/Ea</b>	<b>Hub/Bearing</b>	<b>Price/Ea</b>
<b>Case-IH</b>	Spoked Gauge Wheel	RID Tire <i>Reduced Inner Diameter</i>	4.5" x 16"	MSW553450	\$165.00	MSW446000	\$60.00	MSW205000	\$65.00
			3" x 16"	MSW873300	\$165.00	MSW333000	\$60.00		
		Gauge Wheel Hardware Kit <i>Wheel Assembly Only, No Tire</i>	4.5" x 16"	MSW553000	\$140.00	-	-		
			3" x 16"	MSW873000	\$140.00	-	-		
	Spoked Gauge Wheel	Standard Profile Tire	4.5" x 16"	MSW535450	\$165.00	MSW445000	\$55.00		
			3" x 16"	MSW870300	\$165.00	MSW331000	\$55.00		
RID Tire <i>Reduced Inner Diameter</i>	4.5" x 16"	MSW535451	\$165.00	MSW446000	\$60.00				
	3" x 16"	MSW870301	\$165.00	MSW333000	\$60.00				
Gauge Wheel Hardware Kit <i>Wheel Assembly Only, No Tire</i>	4.5" x 16"	MSW535000	\$140.00	-	-				
	3" x 16"	MSW870000	\$140.00	-	-				
RID (Reduced inner diameter) tire allows seed trench to lift and fracture. Not recommended for use in tilled soil conditions.									
3" wide tires are designed for no-till and high speed planters so less residue is contacting the tire, improving the seed depth consistency.									
2.5" wide tires are designed for no-till and twin row planters so less residue is contacting the tire, improving the seed depth consistency.									



Spoke Covers	Product ID	Price
Mud Flap, Spoked Wheel Cover	MSW000100	\$50.00

# RK PRODUCTS REPAIR KITS

## RK Products Gauge Wheel Arm Repair Kit

Case-IH	Vendor ID	Product ID	Price/Row
800, 900 Series	PR1333	CPH001333	\$142.00
955, 1200, 2000 Series	PR1332	CPH001332	\$142.00
John Deere	Vendor ID	Product ID	Price
7000 MaxEmerge with 5/8" bolt	PR1120	CPH001120	\$87.00
7000 MaxEmerge with 1/2" bolt	PR1110	CPH001110	\$87.00
7200, 7300 MaxEmerge 2	PR1130	CPH001130	\$87.00
MaxEmerge Plus, Pro-Series, XP, Pro-Series XP	PR1150	CPH001150	\$109.00
MaxEmerge 5, ExactEmerge	PR1151A	CPH001151	\$137.00
Kinze	Vendor ID	Product ID	Price
2000, 3000 series with 1/2" bolt	PR1110	CPH001110	\$87.00
White	Vendor ID	Product ID	Price
5000 Series	PR1250	CPH001250	\$95.00
6000 Series	PR1230	CPH001230	\$95.00
6000 Series (single closing wheel)	PR1260	CPH001260	\$95.00
8000 Series	PR1280	CPH001280	\$95.00
9000 Series	PR1290	CPH001290	\$104.00

The **Copperhead RK Gauge Wheel Arm Repair Kit** is different from all other kits on the market, because it supports the offset load in a different way and actually solves the problem. The design utilizes a disc spring to pre-load the outer end of the hub of the arm with enough spring pressure that the arm cannot lean but can pivot freely. Because the arm cannot lean, the pressure remains distributed almost uniformly around the circle of contact which is a large area. The result is that wear is practically eliminated.

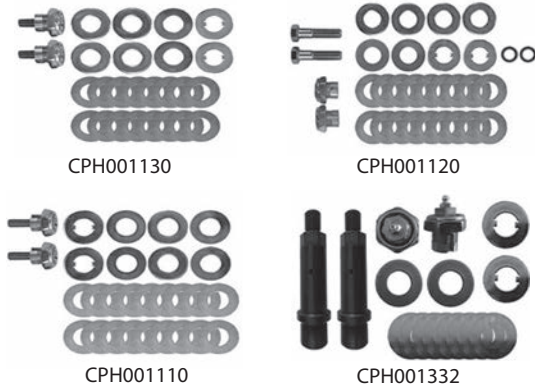

## Closing Wheel Bracket Repair Kit

John Deere	Vendor ID	Product ID	Price/Row
7000, 7100 MaxEmerge with holes	PR3110	CPH003110	\$43.00
7000, 7100 MaxEmerge with slots	PR3120	CPH003120	\$48.00
7000, 7100 MaxEmerge - cam adjustment	PR3150	CPH003150	\$74.00
7200, 7300 MaxEmerge 2	PR3131	CPH003131	\$43.00
MaxEmerge Plus, Pro, XP, Pro-Series XP, ME 5, ExactEmerge - used tail piece	PR3142	CPH003142	\$41.00
MaxEmerge Plus, Pro, XP, Pro-Series XP, ME 5, ExactEmerge - new tail piece	PR3143	CPH003143	\$32.00
Kinze	Vendor ID	Product ID	Price
3000 series	PR3110	CPH003110	\$43.00
White	Vendor ID	Product ID	Price
6000 Series with holes	PR3110	CPH003110	\$43.00
6000 Series with slots	PR3120	CPH003120	\$48.00
8000 Series	PR3260	CPH003260	\$59.00

The **RK Closing Wheel Bracket Repair Kit** replaces the bushing on a closing wheel arm with a bearing. Having the closing wheel arms tight is critical to keeping closing wheels centered on the seed trench and ensuring that your closing wheels can operate at peak performance.



## Drill Arm Repair Kit

John Deere	Description	Vendor ID	Product ID	Price/Row
750	serial number 1 through 3834	PR7111	CPH007111	\$91.00
	serial number 3835 through 5999, straight pin	PR7211	CPH007211	\$72.00
	serial number 3835 through 5999, drilled pin	PR7221	CPH007221	\$77.00
	serial number 6000 & higher	PR7630	CPH007630	\$104.00
60/90 Series serial number 6000 & higher	non-drilled, no seals, bearings or pivot bushings	PR7740	CPH007740	\$62.00
	non-drilled with seals & bearings	PR7750	CPH007750	\$105.00
	drilled bolt, no seals, bearings or pivot bushings	PR7770	CPH007770	\$66.00
	drilled bolt with seals & bushings	PR7730	CPH007730	\$117.00



# REPLACEMENT PARALLEL ARMS

OEM Replacement Parallel Arms				
John Deere				
Model	Description	Product ID	OEM #	Price/Ea
MaxEmerge2, Plus, Pro, XP, XP Pro, 5, ExactEmerge 1530, 1535 with MaxEmerge row units	Upper parallel arm, 16" standard length	PLT762230	A76223	\$19.95
MaxEmerge2, Plus, Pro, XP, XP Pro, 5, ExactEmerge 1530, 1535 with MaxEmerge row units	Lower parallel arm, 16" standard length	PLT520920	A52092	\$114.95
MaxEmerge2, Plus, Pro, XP, XP Pro, 5, ExactEmerge 1530, 1535 with MaxEmerge row units	Upper parallel arm, 23" extended length	PLT615710	A61571	\$25.95
MaxEmerge2, Plus, Pro, XP, XP Pro, 5, ExactEmerge 1530, 1535 with MaxEmerge row units	Lower parallel arm, 23" extended length	PLT843820	A84382, A65304	\$209.95



## PARALLEL LINKAGE REBUILD KITS

### S.I. DISTRIBUTING'S PARALLEL LINKAGE REBUILD KITS FOR JD 7000, 7100; KINZE 2000, 3000

- Replaces worn bushings in parallel linkage
- Oversized bushings last up to four times longer
- Special designed bolts have a shoulder so the bushings don't wear on the bolt threads
- No need to replace parallel linkage because holes are enlarged to accept the new bushings
- Insures a precise fit to eliminate movement between the bushing and the bolt

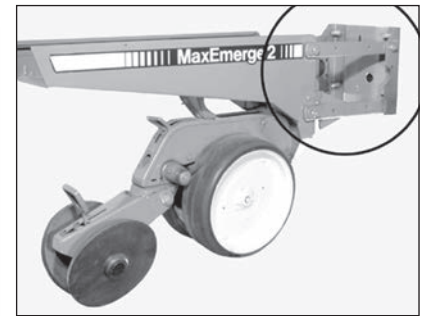
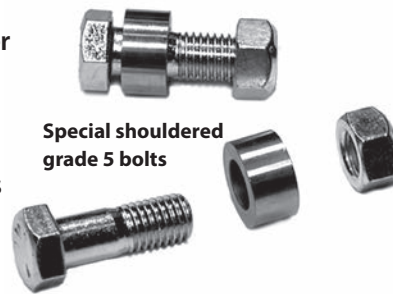

#### Kit includes:

- 8 **oversized** bushings, JD 7000, 7100; Kinze
- 8 **special shouldered grade 5 bolts**
- 8 grade 5 locknuts

**For John Deere 7000, 7100 and Kinze planters MUST DRILL OUT PARALLEL LINKAGE TO 1-3/32".**

Parallel Linkage Rebuild Kit, John Deere 7000, 7100; Kinze			
Per Row Kit	Product ID	Price/Kit	
Parallel linkage rebuild kit, per row (must drill to 1-3/32")	PLT131100	\$45.00	
Drill Bit	Product ID	Price Ea	
Drill Bit, 1-3/32"	PLT130105	\$98.77	
Parallel Linkage Rebuild Kit Components			
Individual Hardware	Qty Per Kit	Product ID	Price Ea
Bushing, each	8	PLT130101	\$1.90
Bolt, 5/8-18 x 1-3/4, each (support plate & lower row unit)	6	PLT131102	\$4.10
Bolt, 5/8-18 x 2-1/4, each (upper row unit)	2	PLT131103	\$4.35
Nut, 5/8-18 lock, each	8	PLT131104	\$0.55

### S.I. DISTRIBUTING'S PARALLEL LINKAGE REBUILD KITS FOR JD 7200, 7300, 1700

**For John Deere 7200, 7300, 1700 series planters NO DRILLING IS REQUIRED. Kit includes same size bushing as original.**

#### Kit includes:

- 8 original-sized bushings, JD 7200, 7300, 1700
- 8 **special shouldered grade 5 bolts**
- 8 grade 5 locknuts

Parallel Linkage Rebuild Kit, John Deere 7200, 7300, 1700			
Per Row Kit	Product ID	Price/Kit	
Parallel linkage rebuild kit, per row (no drilling required)	PLT241100	\$45.00	
Parallel Linkage Rebuild Kit Components			
Individual Hardware	Qty Per Kit	Product ID	Price Ea
Bushing, each (support plate & upper row unit)	6	PLT130101	\$1.90
Bushing, each (lower row unit)	2	PLT130160	\$1.95
Bolt, 5/8-18 x 1-3/4, each (support plate)	4	PLT131102	\$4.10
Bolt, 5/8-18, each (upper & lower row unit)	4	PLT131103	\$4.35
Nut, 5/8-18 lock, each	8	PLT131104	\$0.55

# REBOUNDER SEED DEFLECTORS

Rebounder seed deflectors channel all seeds to the center of the seed trench.

The distinct half-moon notch on the bottom tip of the Rebounder allows it to run 3/8" off the bottom of the furrow. Because the Rebounder does not drag the bottom of the seed bed, it will not build up with mud.

The Rebounder is designed to serve as an extension of the seed tube, and works with the seed tube rather than against it. The Rebounder functions as a stabilizer that keeps the seed tube in the center of the furrow. When mounted to the seed tube, the Rebounder puts less than one pound of pressure on the seed tube while planting. This small amount of pressure in the seed furrow eliminates mud from building up when planting in heavy, wet and textured soils.



Rebounder Liquid Placement Attachments		
Description	Product ID	Price
Y-Not Split-It; Great Plains, Horsch, John Deere, Kinze, Monosem, Precision Planting, White planters; applies liquid to furrow sidewalls	SMS090000	\$6.75
Y-Not Split-It, Case-IH; applies liquid to furrow sidewalls	SMS090006	\$6.75
Y-Not Split-It, drills; applies liquid to furrow sidewalls	SMS090026	\$6.75
Straight Shot; applies liquid directly to seed	SMS090001	\$7.50

Rebounders For Planters		
Case IH	Product ID	Price
800, 900, 950, 955; will not work with Y-Not Splitter (if updating seed boot refer to SMS810003)	SMS810001	\$30.00
1200 (prior to 2009)	SMS810002	\$42.50
1200 (2009 & after)	SMS810003	\$42.50
1200 (with speedtube)	SMS810004	\$44.50
Great Plains	Product ID	Price
YP, 3PYP, 25 series (Clear-Shot seed tubes)	SMS810011	\$30.00
Horsch	Product ID	Price
Maestro	SMS810021	\$30.00
John Deere	Product ID	Price
7000, 7100, 7200, 7300 1700 (MaxEmerge, MaxEmerge 2, ME Plus, ME XP, ME 5)	SMS810031	\$30.00
1700, ExactEmerge without pneumatic down pressure	SMS810033	\$51.95
1700, ExactEmerge with pneumatic down pressure	SMS810032	\$56.95
Kinze	Product ID	Price
2000, 3000; with smaller seed tubes (non EdgeVac & seed tubes prior to 2012)	SMS810031	\$30.00
3000, 4000; with larger seed tubes (EdgeVac & seed tubes 2012 & after)	SMS810041	\$42.50
Monosem	Product ID	Price
NG Series	SMS810031	\$30.00
Precision Planting	Product ID	Price
BullsEye seed tube	SMS810021	\$30.00
WaveVision seed tube	SMS810061	\$42.50
Universal Keeton seed firmer bracket	SMS810062	\$42.50
Quick Attach Keeton seed firmer bracket	SMS810063	\$42.50
White	Product ID	Price
5000, 6000, 8000	SMS810031	\$30.00
9000	SMS810071	\$42.50

Rebounders For Drills		
Amity	Product ID	Price
Amity Drills	SMS910001	\$30.00
Case IH	Product ID	Price
5400, 5500 Soybean Special Drills (if updating seed boot refer to SMS810003)	SMS910011	\$30.00
SDX	SMS910012	\$30.00
5100, 5300, 5400, 5500, 500T, Left Hand	SMS910015	\$42.50
5100, 5300, 5400, 5500, 500T, Right Hand	SMS910016	\$42.50
CrustBuster	Product ID	Price
3400, 3700, 4000	SMS910021	\$48.00
3400, 3700, 4000 with dry fertilizer	SMS910022	\$48.00
FSO (Flexi Coil)	Product ID	Price
FSO Drills; Left	SMS910031	\$42.50
FSO Drills; Right	SMS910032	\$42.50
Great Plains	Product ID	Price
00HD-10HD Heavy Duty & Precision Drills (15" disc)	SMS910041	\$42.50
Solid Stand Drills (13.5" disc)	SMS910042	\$42.50
Krause Drill	Product ID	Price
5200, 5250, 5500	SMS910051	\$42.50
John Deere	Product ID	Price
450, 455, 515, 520, 1520, 830 (press wheel units)	SMS910061	\$42.50
750, 1590, 1690, 1850, 1890, 1990 (9" or 10" press wheel; 10" requires stop kit)	SMS910062	\$10.00
JD press wheel stop kit for 10" wheels 750	SMS090003	\$16.00
JD press wheel stop kit for 10" wheels 1590, 1690, 1850, 1890, 1990	SMS090004	\$11.25
Landoll	Product ID	Price
5500 & Newer	SMS910071	\$42.50
Salford	Product ID	Price
Salford Drills	SMS910081	\$42.50
Sunflower	Product ID	Price
Sunflower Drills	SMS910091	\$42.50
Tye	Product ID	Price
IV, V, 2000	SMS910101	\$42.50
Soybean/Rice special drills	SMS910102	\$42.50

# KINZE BRUSH METER ADAPTER

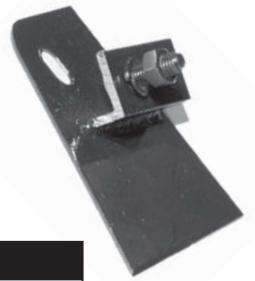

The Kinze brush meter adapter is a conversion kit to adapt a Kinze brush-type seed meter to fit a John Deere 7200, 7300 and 1700 Series Finger pick-up seed box.

Kinze Brush Meter Adapter		
Product ID	Description	Price
PLT000100	Adapter kit, to install Kinze brush meter on John Deere 7200, 7300 and 1700 series planter	\$13.75
<b>Note:</b> Will not work with Kinze Brush Meters manufactured after July 2010 because the shaft is now hardened and very difficult to modify.		

## TRAIL-JET FERTILIZER OPENER

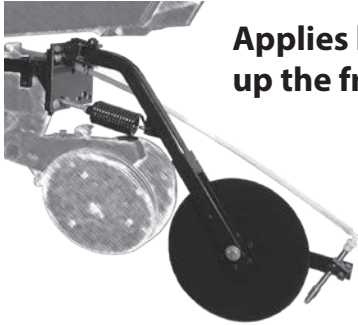

Applies liquid fertilizer behind the planter, freeing up the front of the planter for other attachments

- Allows for split applications of two different types of fertilizer
- Mounts directly on the planter unit – no extra tool bars required
- High pressure assures excellent placement of fertilizer

Trail-Jet Fertilizer Opener		
Description	Product ID	Price
Single Opener	TJT221700	\$235.00
Dual Opener	TJT441700	\$415.00
Note: Price is per row and does not include pump or hoses.		

## SURE MARK MARKER WEIGHT

SURE MARK is a 12-1/2 pound weight that simply bolts on the dish of your marker disk. The additional weight of SURE MARK will assist the disk to cut a much deeper furrow in No-Till planting. For extremely hard No-Till conditions, another weight can be added.

Measurements are required when placing an order.

Longer bolts for installation are not included.

Sure Mark Marker Weight	
Description	Price
Sure Mark Please specify make, model and hub bolt pattern when ordering.	\$79.95



## 4AG PLANTER GAUGE WHEEL TIRES

*The Most Durable on the Market!*

- Durable to sharp stubble and rocks
- No lip wear, keeping dry soil out of seed trench
- Easy installation with no press required



4AG tire - 1,233 acres per tire (to date)



OEM tire 146 acres per tire

4AG Gauge Wheel Tires				
Make	Model	Description	Product ID	Price/Ea
JD Kinze White	ME, ME2, ME Plus, ME Pro 2000, 3000, 4900, 5100, 5700, 6000, 8000, 9000	4.5" x 16	PLT040451	\$125.00
		3" x 16	PLT040301	\$96.00
JD	XP, XP Pro, ME5, ExactEmerge	4.5" x 16	PLT040452	\$125.00
		3" x 16	PLT040302	\$96.00

# CLOSING WHEEL BRACKETS

Manufactured by S.I. Distributing, creating an accurate closing wheel angle for an optimum closing.

## Closing Wheel Bracket Kits / Brackets Only

John Deere	Closing Wheel Type	Description	Bracket Kit	Price	Bracket Only	Price
MaxEmerge (7000, 7100)	Roll Pin	For roll pin attached closing wheels.	PLT120700	\$69.95	PLT120757	\$43.95
	Bolt On	For bolt-on closing wheels. Includes hardware kit to bolt wheels on bracket. (Must convert to bolt on style closing wheels)	PLT120730	\$67.95	PLT120760	\$36.95
Max Emerge 2, MaxEmerge Plus, Pro-Series, MaxEmerge XP, Pro-Series XP, MaxEmerge 5, ExactEmerge (7200, 7300, 1700, DB)	Bolt On	For bolt-on closing wheels. Includes hardware kit to bolt wheels on bracket. (MaxEmerge 2 row units must convert to bolt on style closing wheels)	PLT120740	\$67.95	PLT120762	\$36.95
Kinze	Closing Wheel Type	Description	Bracket Kit	Price	Bracket Only	Price
2000 Series	Roll Pin	Closing Wheel Bracket Kit, for roll pin attached closing wheels	PLT120710	\$69.95	PLT120758	\$43.95
2000, 3000, 4000 Series	Bolt On	For bolt-on closing wheels. Includes hardware kit to bolt wheels on bracket. (Early 2000 series must convert to bolt on style closing wheels)	PLT120720	\$67.95	PLT120761	\$36.95

Note: Bracket kit includes bracket, t-handle, spring, eccentric bushings and hardware

### Closing Wheel Bracket Replacement Parts

Description	Product ID	Price
Eccentric Bushing	PLT120660	\$3.95
Hex Step Bushing	PLT120661	\$1.95



PLT120720 - Black  
PLT120730 - Green  
PLT120740 - Green

## CLOSING WHEEL CONVERSION BRACKET

### White Closing Wheel Bracket Rebuild Kit

White	Description	Product ID	Price
6000	Includes new bolt-on arms, eccentric bushings, hex bushings and hardware.	PLT120618	\$29.95

### Case-IH/White V-Closing Wheel Conversion Kit

White	Description	Product ID	Price
5000, 6000	Converts closing system from OEM packer wheel to "V" closing wheels. Includes shim washers for spacing wheels to desired width. Will only fit planters if H-bracket arm is straight and down pressure springs are on the inside.	PLT125001	\$44.95
Case-IH	Description	Product ID	Price
800, 900, 1200	Converts closing system from OEM packer wheel to "V" closing wheels. Includes shim washers for spacing wheels to desired width.	PLT125101	\$84.95



**White 6000**  
PLT120618



**White Planter**  
PLT125001



**Case-IH Planter**  
PLT125101

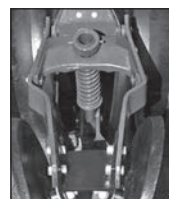

PLT125101



## TRASH GUARD

**Keeps your planter v-closing wheels free of old stalks, lumps of soil and other field debris.**

- Improves planting results
- Saves time and money on maintenance
- For all John Deere, Kinze and White planters
- Bolts easily between the closing wheels
- Includes installation hardware

Trash Guard		
Product ID	Description	Price
PLT126000	Trash guard kit, John Deere, Kinze and White planters	\$11.95

## DEPTH-A-MATIC

- More equal compaction on either side of the disk enhances seed to soil contact and equal emergence
- Less bearing failure on depth gauge wheels

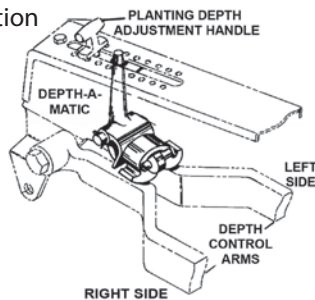

**The Depth-A-Matic allows the depth gauge wheels to follow the ground terrain allowing the unit to travel smoothly in all field conditions.**

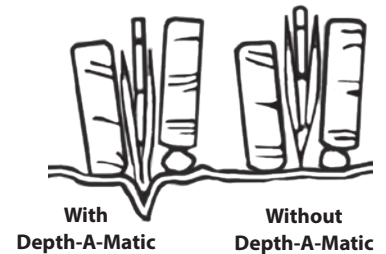

### Consistent Seed Depth Control!

Product ID	Description	Price
DAM001000	Depth-A-Matic, John Deere 7000, 7100; Kinze & New Idea planters. Does not fit Kinze 3000 series row units.	\$38.95
DAM002000	Depth-A-Matic, JD 7200, 7300 & 1700 series. Does not fit John Deere XP, XP Pro row units.	\$52.95
Depth-A-Matic Replacement Parts		
DAM003100	Rocker, for Depth-A-Matic	\$14.95
DAM003200	Roll pin, for Depth-A-Matic	\$0.50

### Each package includes:

- 4 Detent pins
- 4 Anchors
- 4 Heavy duty down pressure springs

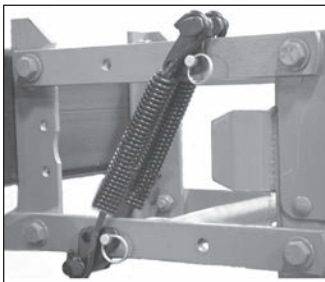

## DOWN PRESSURE SPRING PACKAGE

**Equals or exceeds competitive designs in DOWN FORCE in normal working ranges**

Down Pressure Spring Kit		
Product ID	Description	Price
PLT141000	Down pressure spring kit, per row	\$130.00
PLT141001	Down pressure spring kit with plate, per row <b>Note:</b> The spring kit with plate is for planter row units that currently do not have a plate installed to hold the u-bolts square and keep the parallel linkage arms from twisting.	\$150.00
Down Pressure Spring Kit Components		
Product ID	Description	Price
PLT141010	Detent pin, 4 per kit, each	\$6.10
PLT141011	Anchor, 4 per kit, each	\$18.10
PLT141012	Spring, 4 per kit, each	\$10.00

## ACRE PLUS SEED BOX TOPPER

The one-piece plastic snap-on extensions require no modifications to the original box and uses the existing seed box lid, and are available in original equipment colors.

*Acre Plus - Seed Box Extensions fits John Deere, and Kinze poly seed boxes.*



Acre Plus Seed Box Topper				
Make	Model	Description	Product ID	Price
John Deere	7200, 7300 (1995 & newer with poly boxes) 1700 series	Seed Box Extensions	PDM030000	\$44.95
Kinze	3000 series (2001 & newer with poly boxes)	Seed Box Extensions	PDM033000	\$44.95

# M3 MONITOR SYSTEM

## Population Monitor for Planters and Grain Drills

Designed to be accurate, user friendly, dependable and affordable.

### M3 Monitor Kits

Grain Drill Kits		
Description	Product ID	Price
4-row drill, rigid, 10-20'	AGT30040102	\$1,976.10
4-row drill, folding, 20-25'	AGT30040202	\$2,206.05
4-row drill, folding, 30'	AGT30040302	\$2,295.30
4-row drill, tandem, 10-15'	AGT30040402	\$2,383.50
6-row drill, rigid, 10-20'	AGT30060102	\$2,648.10
6-row drill, 3-fold, 30'	AGT30060302	\$2,648.10
8-row drill, rigid, 10-20'	AGT30080102	\$3,089.10
8-row drill, front fold, 30'	AGT30080302	\$3,266.55
8-row drill, tandem, 10-15'	AGT30080402	\$3,266.55
12-row drill, rigid, 10-20'	AGT30120102	\$3,972.15
16-row drill, folding, 20-25'	AGT30160202	\$5,031.60
16-row drill, folding, 30'	AGT30160203	\$5,031.60

Requires speed sensor - sold separately - chart right

### Planter Kits; John Deere 7000, 7100; Kinze 2000, 3000

Description	Product ID	Price
4-row planter, rigid	AGT30045051	\$2,206.05
6-row planter, rigid	AGT30065051	\$2,398.20
8-row planter, rigid	AGT30085051	\$3,089.10
8-row planter, rear fold	AGT30085251	\$3,266.55
8-row planter, front fold	AGT30085351	\$3,266.55
12-row planter, rigid	AGT30125051	\$3,972.15
12-row planter, rear fold	AGT30125251	\$4,147.50
12-row planter, front fold	AGT30125351	\$4,147.50
16-row planter, rigid	AGT30165051	\$4,855.20
16-row planter, rear fold	AGT30165251	\$5,031.60
16-row planter, front fold	AGT30165351	\$5,031.60

Requires speed sensor - sold separately - chart right

### Planter Kits; John Deere 7200, 7300, 1700

Description	Product ID	Price
4-row planter, rigid	AGT30045052	\$2,206.05
6-row planter, rigid	AGT30065052	\$2,648.10
8-row planter, rigid	AGT30085052	\$3,089.10
8-row planter, rear fold	AGT30085252	\$3,266.55
8-row planter, front fold	AGT30085352	\$3,266.55
12-row planter, rigid	AGT30125052	\$3,972.15
12-row planter, rear fold	AGT30125252	\$4,147.50
12-row planter, front fold	AGT30125352	\$4,147.50
16-row planter, rigid	AGT30165052	\$4,855.20
16-row planter, rear fold	AGT30165252	\$5,031.60
16-row planter, front fold	AGT30165352	\$5,031.60

Requires speed sensor - sold separately - chart right

Using an Intel® microprocessor, the M3 monitors speed, area, population, hopper levels, limit switch status, seed spacing, and row failure to keep the operator informed of the current status of the planter or drill. The M3 has two separate sets of setup parameters that may be entered and retained, eliminating the need to re-enter values when switching planters or drills. Every feature of the M3 has been designed to be as simple to operate as possible, thereby eliminating confusion and unnecessary down time.

- Saves time and money by not over seeding
- Display two different sets of data on the screen
- Choose from MPH, field acres, total acres, acres per hour, row population, average population, row seed spacing and average seed spacing

**Loud Alarm** sounds when a row fails and notifies you which row failed. Silence with a push of the button

**Bright Backlit Display** You can see this display in a bright light or in darkness.



**Anodized Aluminum Bracket** Mount the M3 either on the dash with bracket beneath or from the cab ceiling with the bracket above.

**Sealed Enclosure** protects the unit from the elements and allows for years of reliable service.

**Easy Click Wheel** No small keys or fine print, it's as easy as adjusting the volume on your radio.

### M3 Monitor Speed Sensors

Description	Product ID	Price
Gear tooth sensor kit, for RPM or ground speed sensing	AGT10006525	\$144.38
Astro 5 GPS Speed Sensor, 5Hz update rate	MTS901428	\$725.00

### M3 Monitor Accessories

Description	Product ID	Price
Limit switch kit (disables acre counter when implement is raised)	AGT10006518	\$204.75
Sensor, planter, DICKEY-john, high-rate	AGT10002640	\$130.00
Sensor, drill, DICKEY-john, high-rate	AGT10003389	\$145.00

### M3 Monitor Replacement Components

Description	Product ID	Price
M3 console, includes DICKEY-john cab cable	AGT1050300001	\$1,149.75
M3 console, includes Computer-Trak cab cable	AGT1050300002	\$1,149.75
Cab cable, M3 monitor, DICKEY-john pinout, 12'	AGT10009000	\$128.10
Cab cable, M3 monitor, Computer-Trak pinout, 12'	AGT10005800	\$128.10
Power cable, M3 monitor, 18'	AGT10003795	\$49.35
Adapter kit, John Deere drill seed tubes	AGT10006552	\$23.10

### Each Kit Includes:

- M3 Monitor Console
- Power Cable
- Cab Harness
- Planter or Grain Drill Harness
- DICKEY-john® High-Rate Seed Sensors
- New Seed Tubes for Planters
- Seed Tube Adapters for Drills (if required)



# PRO CHUTE

Empty your seed boxes directly, smoothly and quickly into your planter

**In as little as two to four minutes you can empty 50 units of soybeans**

**Use for loading and unloading your planter**

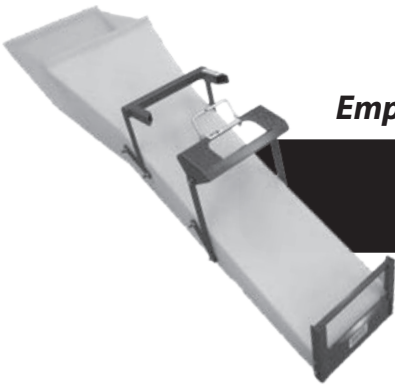

- Our PRO Chute snaps into your seed box in under five seconds, without looking underneath to line up brackets. Never stand underneath a raised box again. There is a full 79" of clearance from the lift to the end of the PRO Chute giving you maximum clearance.
- Quick attach for safe unloading
- Slide Gate controls the seed flow.

- Seed flows smoothly and quickly when you attach the PRO Chute to your bulk seed box. The funnel system is made of poly for durability, wear resistance, and slick properties.



PRO Chute		
Product ID	Description	Price
PLT082652	Pro Chute I, Yellow, 7.5" x 62"; <b>4 min</b>	\$525.00
PLT082653	Pro Chute II, Blue, 10.5" x 62"; <b>2 min</b>	\$525.00
PRO Chute Extensions		
Product ID	Description	Price
PLT082654	18" Extension, Pro Chute I, Yellow	\$75.00
PLT082656	18" Extension, Pro Chute II, Blue	\$75.00
PLT082655	36" Extension, Pro Chute I, Yellow	\$100.00
PLT082657	36" Extension, Pro Chute II, Blue	\$100.00

## Quick attach for safe unloading

All-metal PRO Chute extensions, available in 18" and 36", easily hang on slide gate for extra length and safety.

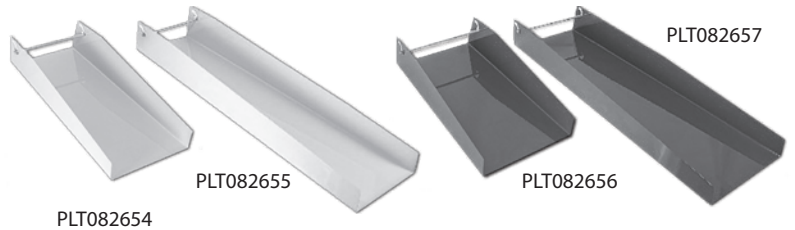

# BULK SEED SYSTEMS SEED SLIDE

**Safely and efficiently empty your bulk seed boxes**

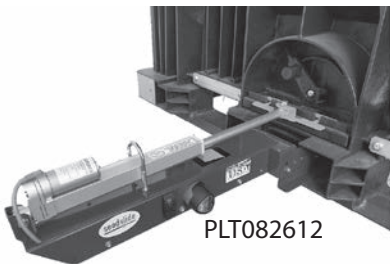

- Push a button instead of climbing wagons
- Increase safety and productivity
- Long-lasting rechargeable batteries
- Operate up to 150 feet away
- Weighs only 13 lbs.



Seed Slide		
Description	Product ID	Price
Milwaukee M12 battery, Included	PLT082612	\$800.00
Milwaukee M18 battery, Not included	PLT082618	\$800.00
DeWalt 20v battery, Not included	PLT082620	\$800.00

Visit our website for the most current product pricing [www.sidist.com](http://www.sidist.com)

# A-1 IMPLEMENTS JD DEPTH ADJUSTMENT PARTS

## Zero Maintenance System



**Before:**  
OEM Depth Control



**After:**  
A-1 Implements Depth Control



When the OEM Air Seeder Depth Control wears out you will see uneven depth across the entire toolbar. This is caused when the weak stamped steel gets worn or warped.

### The A-1 Air Seeder Depth Control:

- Made from laser cut steel that is more than double the thickness of the OEM stamped steel
- No Need to grease, and the arm will not seize.
- The stud makes for quick, easy, and accurate gauge wheel settings
- Accurate horizontal depth settings
- Pin adjust

Make/Model	Description	Product ID	Price
John Deere 60, 65, 90, 95, Pro Series	Left Hand Upper Assembly, includes cover plate & handle	AOS021225	\$159.00
	Right Hand Upper Assembly, includes cover plate & handle	AOS011225	\$159.00

Make/Model	Description	Product ID	Price
John Deere 60, 65, 90, 95, Pro Series	Left Hand Lower Assembly, includes spindle assembly & stud	AOS041225	\$200.00
	Right Hand Lower Assembly, includes spindle assembly & stud	AOS031225	\$200.00

Make/Model	Description	Product ID	Price
John Deere 60, 65, 90, 95, Pro Series	Left Hand Full Assembly, includes cover plate, handle, spindle assembly & stud	AOS061225	\$359.00
	Right Hand Full Assembly includes cover plate, handle, spindle assembly & stud	AOS051225	\$359.00

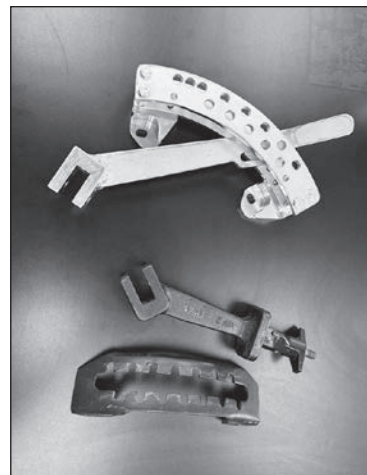

## ROW CLEANER FOR JOHN DEERE 60/90 OPENERS



This row cleaner fits John Deere 60/90 Openers to add residue-clearing capability. This unit operates in front of the opener blade to create improved seeding conditions.

- Floating design allows unit to follow soil contour
- Mounts directly to the seed opener cast arm
- Moves residue in front of blade and seed boot to reduce hairpinning and clear area; this warms soils more quickly and leads to improved emergence
- Available with bevel wheel, sharktooth finger wheel, and sharktooth wheel.
- Floater wheel options are aluminum floater wheel, and poly floater wheel.



Description	Without Floater Wheel	Price/Each	With Floater Wheel	Price/Each
Left Hand Residue Manager	YTR100300	\$600.00	YTR200300	\$640.00
Right Hand Residue Manager	YTR200300	\$600.00	YTR400300	\$640.00

# ARICKS AIR SEEDER REPLACEMENT PARTS



## NON-GREASABLE GAUGE WHEEL AXLE KIT

Designed for John Deere 90 and Pro-Series openers, the Aricks Non-Grease Gauge Wheel Axle Kit eliminates the common problem of seized axles caused by dust buildup and hardened grease. Without this kit, farmers often have to remove the entire disc opener and use a hydraulic press to free stuck axles, which can be a difficult and time-consuming process.



**INCLUDES SELF-LUBRICATING BUSHINGS WITH INTEGRATED SEALS THAT PREVENT DUST FROM GETTING IN.**

Make/Model	Description	Product ID	Price
John Deere 90, 95 & Pro-Series	Left Hand Gauge Wheel Axle Kit	ARC250510	\$189.00
	Right Hand Gauge Wheel Axel Kit	ARC250500	\$189.00

## ARM ASSEMBLY DEPTH ADJUST

The Aricks Arm Assembly Depth Adjust is engineered for long-lasting performance in the toughest conditions. Built from high-quality cast steel and reinforced for added strength, it minimizes wear so you can maintain precise depth settings without constant replacement. Offering up to 50% savings compared to OEM parts, the Aricks Depth Adjust system delivers a durable, cost-effective upgrade for your John Deere openers.



**RELIABLE SEED DEPTH CONTROL, INCREASING THE EFFICIENCY OF YOUR SEEDING OPERATIONS**

Make/Model	Description	Product ID	Price
John Deere 60, 65, 90, 95, & Pro-Series	Left Hand Arm Assembly Depth Adjust	ARC882109	\$94.50
	Right Hand Arm Assembly Depth Adjust	ARC882108	\$94.50

## HEAVY DUTY COVER PLATE & T HANDLE

The Aricks Heavy-Duty Cover Plate and T Handle are built for superior durability and precise depth control. The cover plate is 100% thicker than OEM, and the solid-tab T handle prevents rattle wear and pin breakage for long-lasting performance. Horizontal slotting provides better engagement, reducing wear and keeping your depth settings securely locked, even in the toughest field conditions.



**STRENGTHEN YOUR DEPTH CONTROL!**

Make/Model	Description	Product ID	Price
John Deere 60, 65, 90, & 95	T-Handle Kit (inc. spring & nut)	ARC882710	\$36.70
	Heavy Duty Cover Plate	ARC883120	\$37.80

## SEED BOOT

The Aricks Seed Boot is engineered for precise seed placement and eliminates vertical play with its unique shouldered bolt system. Constructed from cast composite Ni-Hard 4, this durable boot is compatible with John Deere 90 and Pro Series openers. Its universal design makes it the only seed boot that works across multiple systems. A wide seed delivery passage minimizes mounting hole wear, ensuring consistent performance and improved crop establishment in all field conditions.



**IMPROVE SEED PLACEMENT WITH THE ONLY UNIVERSAL SEED BOOT ON THE MARKET**

Make/Model	Description	Product ID	Price
John Deere 90, 95, Pro-Series	Left Hand Seed Boot Kit	ARC240750	\$157.50
	Right Hand Seed Boot Kit	ARC250750	\$157.50

## WHEEL RESIDUE MANAGER

Designed for no-till seeding, the Aricks Residue Manager clears residue while preserving essential soil moisture and carbon, optimizing planting conditions. Its unique design reduces erosion, improves water infiltration, and enhances seed-to-soil contact for better germination. Compatible with John Deere Air Seeders, it eliminates hair pinning and is built from heavy-duty Bisalloy steel and cast components for long-lasting performance in tough conditions. Improve efficiency, boost yields, and modernize your no-till seeding system with this essential tool.



**CLEAR THE PATH FOR MAXIMUM CROP POTENTIAL WITH THE ARICKS RESIDUE MANAGER**

Make/Model	Description	Product ID	Price
John Deere 1590, 1890, 1895	Left Hand Residue Manager	ARC251100	\$529.00
	Right Hand Residue Manager	ARC252100	\$529.00

# NEEDHAM AG V8 DRILL FIRMING WHEEL



## Improve Crop Emergence by Ensuring Seed Placement

The Needham Ag V8 Firming Wheel's proven profile, the only one on the market which matches the shape of the seed slot, combines with the flexible green urethane tire.

The Needham Ag V8 features the Peer SeedXTreme heavy duty bearing to extend service life further. It incorporates 12 seals (6 each end) to better keep dust and other materials out.

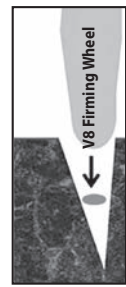

## Flexible!



- The V8 tire profile is specifically designed to match the offset... tapered profile of the John Deere single disc seed slot.
- Increased durability.
- Flexibility to help shed mud, especially in moist clay soils.
- Helps keep the firming wheel down within the seed slot, especially when operating on hillsides and when making slight turns.

## Firming Wheels Compared

	John Deere Part #: AN281359	John Deere Part #: AN282296	Needham Ag V8 Firming Wheel
Tire Design Profile			

NOTE: Each V8 wheel is shipped with a longer (3.5") Grade 8 x 5/8" low profile head bolt, nylon lock nut and washer, to mount the V8 firming wheel to the existing firming wheel arm. (A longer bolt is required, because the long-life bearing is wider than all other firming wheel bearings).

## Needham Ag V8 Firming Wheel

Product ID	Description	Price
DRL400010	Needham Ag V8 firming wheel, JD drill	\$49.00

# NEEDHAM AG EXTENDED WEAR SEED BOOTS

Needham Ag Extended Wear Seed Boots last up to 2.5 times longer than John Deere's standard-wear seed boots (part number N284045). When you factor in the time and labor required to install and remove standard boots, most growers quickly see the value in upgrading to the Extended Wear design.

These seed boots are engineered for durability and convenience. They mount directly to 60- and 90-series opener arms with no drilling required, saving time and eliminating installation headaches.



NDM290025



NDM250317

John Deere	Description	Product ID	Price
60, 90, 95 Series	Left Hand Seed Boot Kit	NDM290025	\$116.00
	Right Hand Seed Boot Kit	NDM290024	\$116.00
If upgrading the 60 series from the two-piece seed boot, a new 90 series stainless steel seed tube is required.			
Includes seed boot and bushing kit			
John Deere	Description	Product ID	Price
50 Series	Left Hand Seed Boot Kit	NDM250317	\$97.00
	Right Hand Seed Boot Kit	NDM250316	\$97.00
Includes seed boot and bushing kit			

# WEARPARTS DRILL DISC OPENERS

## Achieves 30-40% Longer Wear than Competing Openers!

Improved life with sharp cutting-edge retention due to high hardness.

- Better blade to soil contact
- Blades do not roll over or break in rocky soils

**3 ZONES OF HARDNESS**

**1 Increased Flexibility**  
(49-50 HRC)

**2 Increased Durability**  
(50-55 HRC)

**3 Maximum Wear**  
(55-58 HRC)



WearParts Drill Disc Openers					
Model	Diameter	Thickness	Product ID	OEM ID	Price/Ea
<b>Case-IH</b>					
500, 500T (will NOT fit SDX series)	18.00"	5mm	WPT018099	87488385	\$57.95
<b>John Deere</b>					
750, 1560, 1565, 1590, 1690, 1835, 1850, 1860, 1890, 1895, 1990 (Celsan)	18.00"	5mm	WPT918052	N283804, N214190	\$29.00
750, 1560, 1565, 1590, 1690, 1835, 1850, 1860, 1890, 1895, 1990 (Forges de Niaux)	18.00"	5mm	WPT018052	N283804, N214190	\$69.31
<b>New Holland</b>					
P2080, P2085 (will NOT fit SDX series)	18.00"	5mm	WPT018099	87488385	\$57.95

# NINJA SEED BOUNCE FLAP

**CLOSE THE GAP! ...Keep More Seeds in the Furrow!**

**Proven to Outlast Other Flaps by Five Times!**

The unique 20° forward bend closes the gap left by OEM flaps, keeping more seeds in the furrow. Since it is flexible and less likely to break in the field, it is proven to outlast other flaps by five times.

The flap on the seed boot is what keeps seeds from bouncing out of the furrow, and this is even more critical on air drills, since the air stream is also trying to escape and may carry seeds along with it. JD & aftermarket flap suppliers use a straight flap, made from materials that are too brittle—often snapping off in the field. The issue with straight flaps is that it leaves a triangular gap for seeds to escape, and this gap gets larger when the straight flaps bend upward during use, due to riding on the sidewall.



20° Forward Bend

Gap with OEM Flap

No Gap



Ninja Seed Bounce Flap		
Product ID	Description	Price
EXP004708	John Deere 50, 90 series	\$7.30
EXP410572	John Deere Pro-Series, includes left hand and right hand flap	\$15.00

## Put the Weight Where It Belongs!

The Hydra-Maxx Down Pressure System Equally Distributes Weight Across the Entire Air Seeder.

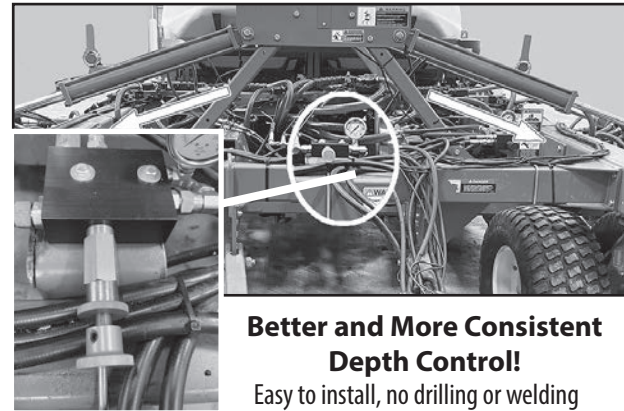

**Better and More Consistent Depth Control!**

Easy to install, no drilling or welding



# HYDRA-MAXX

AIR SEEDER WING DOWN PRESSURE SYSTEM

- No more need for suitcase weights on the wings, which means less stress on frame bolts
- Built-in relief valve added for cylinder protection

Hydra-Maxx Down Pressure System			
Make/Model	Width	Product ID	Price
<b>Case-IH</b>			
500T, 500DS	25', 30', 40'	HMX030040	\$2,895.00
<b>John Deere</b>			
1690, 1860, 1890, 1895, 1990	30'	HMX010030	\$2,195.00

Only fits single-fold air seeders.

## ONE WRENCH Works in Seconds - One Hand, One Motion

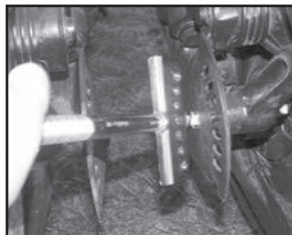

**Adjusts John Deere 750 & 1850 Grain Drills Depth Using Only One Hand and One Wrench**

The unique design of the One Wrench™ incorporates several pads that are used to depress the locking pin of the adjusting plate. Upon releasing the locking pin you can adjust the grain drill to the desired depth.

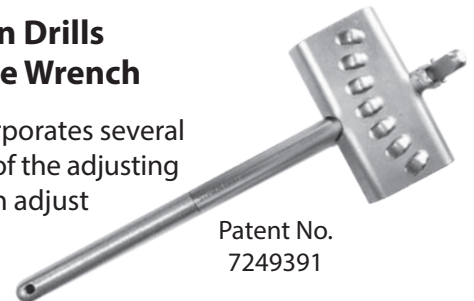

Patent No. 7249391

Product ID	Description	Price
DRL010001	One Wrench	\$69.95

# S.I. BELT METER

## Maintain Accurate Population Control!

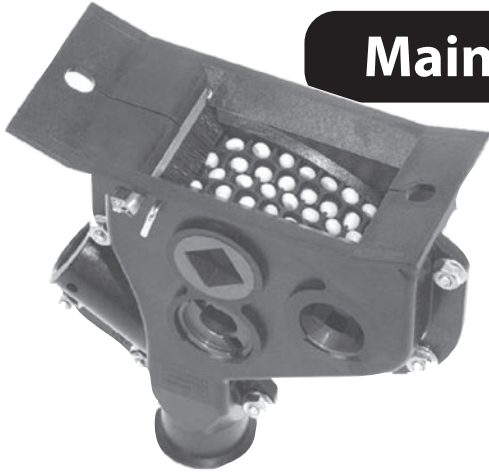

The S.I. Belt Meter allows you to seed with one setting at a determined, regularly-even rate of flow.

- A regular even rate of seed flowing from the meter at all times
- Seed damage at the meter is greatly reduced or eliminated
- There is a positive setting by adjusting meter speed
- The flow rate remains constant up to 10 mph
- Plants soybeans, wheat and oats

**\* SAVE MONEY - no over seeding \***

**\* MAKE MONEY due to no under seeding \***

**\* Any variation in seeding rate is eliminated \***

Now you can plant the seed population per acre you choose without guessing. Accurate population control is possible even on large.

Now you can plant the seed population per acre you choose without guessing. Accurate population control is possible even on large seed crops such as soybeans. The S.I. Belt Meter, when mounted on a grain drill, will singulate the seed and maintain accurate population control over a wide range of seed sizes (**2,000 to 4,000 actual seeds per pound**).

**The S.I. Belt Meter is designed to primarily plant the following crops: Soybeans at 2,000 to 4,000 actual seeds per pound, wheat and oats. The S.I. Belt Meter is not designed (and does not work well) on crops planted at low rate or of a non-symmetrical shape such as milo/sorghum, corn, sunflower, cotton and edible beans.**

Any guess work in setting rate is eliminated. For most seed sizes, the meter will plant your seed at the rate you establish. The conversion pays for itself through seed savings and virtually eliminating seed damage.

### S.I. BELT METER KITS

#### All kits include:

- S.I. Belt Meter for each opener
- Transmission conversion kit(s)
- New seed charts
- Installation instructions
- Extra belt meter, cutoff brush, cotter pin

## S.I. BELT METER PARTS

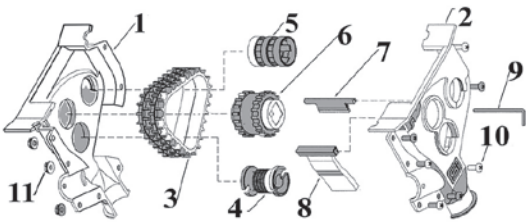

S.I. Belt Meter Service Parts		
Product ID	Description	Prc/Ea
BMP006169	Soybean screen, used to accurately check seed size	\$21.25
BMP008100	S.I. Distributing will disassemble, inspect, repair and reassemble your meters. Parts not included in price.	\$9.75
BMP008151	Steel meter fixture holds the meter and nuts in place to ensure easier meter repair for do-it-yourselfers.	\$44.75



### S.I. Belt Meter Parts

Key	Product ID	Description	Qty/ Meter	Price Each
	BMP001000	Belt Meter, John Deere, complete		\$99.00
	BMP001005	Retaining cap, John Deere*; fits on top of meter	1	\$8.75
	BMP001500	Belt Meter, clear, with handle, for display purposes only, complete		\$99.00
	BMP002000	Belt Meter, Great Plains, angled top, complete		\$99.00
	BMP002005	Retaining cap, angled top; fits on top of meter	1	\$8.75
	BMP003000	Belt Meter, Great Plains, Case-IH, flat top, complete		\$99.00
	BMP003005	Retaining cap, Great Plains, Case-IH, flat top*; fits on top of meter	1	\$8.75
1	BMP005000	Meter housing, John Deere, right hand	1	\$14.25
2	BMP005001	Meter housing, John Deere, left hand	1	\$14.25
	BMP005002	Meter housing, Great Plains, Case-IH, flat top, right hand	1	\$14.25
	BMP005003	Meter housing, Great Plains, Case-IH, flat top, left hand	1	\$14.25
	BMP005004	Meter housing, Great Plains, angled top, left hand	1	\$14.25
	BMP005005	Meter housing, Great Plains, angled top, right hand	1	\$14.25
3	BMP005008	Seed belt	2	\$7.25
4	BMP005014	Lower idler	1	\$3.95
5	BMP005013	Spool	1	\$3.95
6	BMP005012	Drive sprocket	1	\$22.50
7	BMP005009	Brush, cutoff	1	\$8.50
8	BMP005011	Brush, drop	1	\$11.95
9	BMP005022	Cotter pin, humped	1	\$1.25
10	BMP005015	Screw, Phillips head, #10-24 x 1/2	7	\$0.20
11	BMP005016	Flange nut, #10-24	7	\$0.35
	BMP005018	Cap, plastic, for grass seed tube*	1	\$1.65

# S.I. BELT METER KITS

Each kit includes an extra belt meter, cutoff brush & cotter pin!

John Deere Belt Meter Kits							
Product ID	Model	Width			Meters		Kit Prices
		Model	Spacing	Drives	Drives	Kit Prices	
BMK12560455	455	25'	6"	49	2	\$6,481.00	
BMK12575455	455	25'	7.5"	40	2	\$5,792.00	
BMK12510455	455	25'	10"	30	2	\$4,655.00	
BMK12515455	455	25'	15"	20	2	\$3,693.00	
BMK13060455	455	30'	6"	60	3	\$8,354.00	
BMK13075455	455	30'	7.5"	48	3	\$7,201.00	
BMK13010455	455	30'	10"	36	3	\$6,048.00	
BMK13015455	455	30'	15"	24	3	\$4,894.00	
BMK13575455	455	35'	7.5"	56	3	\$7,970.00	
BMK13510455	455	35'	10"	42	3	\$6,624.00	
BMK11075750	750	10'	7.5"	16	1	\$2,493.00	
BMK11010750	750	10'	10"	12	1	\$2,108.00	
BMK11015750	750	10'	15"	8	1	\$1,724.00	
BMK11575750	750	15'	7.5"	24	1	\$3,309.00	
BMK11510750	750	15'	10"	18	1	\$2,685.00	
BMK11515750	750	15'	15"	12	1	\$2,108.00	
BMK12075750	750	20'	7.5"	32	2	\$4,836.00	
BMK12010750	750	20'	10"	24	2	\$4,067.00	
BMK12015750	750	20'	15"	16	2	\$3,298.00	
BMK13075750	750	30'	7.5"	48	2	\$6,376.00	
BMK13010750	750	30'	10"	36	2	\$5,222.00	
BMK13015750	750	30'	15"	24	2	\$4,067.00	
BMK115751520	1520	15'	7.5"	24	1	\$3,309.00	
BMK120751520	1520	20'	7.5"	32	2	\$4,836.00	
BMK120101520	1520	20'	10"	24	2	\$4,067.00	
BMK115151530	1530	15'	15"	12	1	\$2,108.00	
BMK120151530	1530	20'	15"	16	1	\$3,222.00	
BMK110751560	1560	10'	7.5"	16	1	\$2,493.00	
BMK110151560	1560	10'	15"	8	1	\$1,724.00	
BMK115751560	1560	15'	7.5"	24	1	\$3,309.00	
BMK115101560	1560	15'	10"	18	1	\$2,685.00	
BMK115151560	1560	15'	15"	12	1	\$2,108.00	
BMK120751560	1560	20'	7.5"	32	2	\$4,836.00	
BMK120101560	1560	20'	10"	24	2	\$4,067.00	
BMK120151560	1560	20'	15"	16	2	\$3,298.00	
BMK130751560	1560	30'	7.5"	48	2	\$6,376.00	
BMK130101560	1560	30'	10"	36	2	\$5,222.00	
BMK130151560	1560	30'	15"	24	2	\$4,067.00	
BMK110751590	1590	10'	7.5"	16	1	\$2,493.00	
BMK110151590	1590	10'	15"	8	1	\$1,724.00	
BMK115751590	1590	15'	7.5"	24	1	\$3,309.00	
BMK115101590	1590	15'	10"	18	1	\$2,685.00	
BMK115151590	1590	15'	15"	12	1	\$2,108.00	
BMK120751590	1590	20'	7.5"	32	2	\$4,836.00	
BMK120101590	1590	20'	10"	24	2	\$4,067.00	
BMK120151590	1590	20'	15"	16	2	\$3,298.00	
BMK130751590	1590	30'	7.5"	48	2	\$6,376.00	
BMK130101590	1590	30'	10"	36	2	\$5,222.00	
BMK130151590	1590	30'	15"	24	2	\$4,067.00	

Great Plains Belt Meter Kits							
Product ID	Model	Width			Meters		Kit Prices
		Model	Spacing	Drives	Drives	Kit Prices	
BMK212601200	1200	12'	6"	24	1	\$3,398.00	
BMK212701200	1200	12'	7"	20	1	\$3,066.00	
BMK212751200	1200	12'	7.5"	19	1	\$2,971.00	
BMK212801200	1200	12'	8"	18	1	\$2,876.00	
BMK212101200	1200	12'	10"	14	1	\$2,496.00	
BMK212701205	1205	12'	7"	20	1	\$3,066.00	
BMK212701210	1210	12'	7"	20	1	\$3,132.00	
BMK212751210	1210	12'	7.5"	19	1	\$3,037.00	
BMK212801210	1210	12'	8"	18	1	\$2,942.00	
BMK212101210	1210	12'	10"	14	1	\$2,562.00	
BMK215601500	1500	15'	6"	30	1	\$4,015.00	
BMK215701500	1500	15'	7"	26	1	\$3,628.00	
BMK215751500	1500	15'	7.5"	24	1	\$3,398.00	
BMK215801500	1500	15'	8"	22	1	\$3,256.00	
BMK215101500	1500	15'	10"	18	1	\$2,876.00	
BMK215151500	1500	15'	15"	12	1	\$2,307.00	
BMK215161500	1500	15'	16"	12	1	\$2,307.00	
BMK215701510	1510	15'	7"	26	1	\$3,702.00	
BMK215751510	1510	15'	7.5"	24	1	\$3,512.00	
BMK215801510	1510	15'	8"	22	1	\$3,322.00	
BMK215101510	1510	15'	10"	18	1	\$2,942.00	
BMK220602000	2000	20'	6"	40	2	\$5,792.00	
BMK220702000	2000	20'	7"	34	2	\$5,223.00	
BMK220752000	2000	20'	7.5"	32	2	\$5,147.00	
BMK220802000	2000	20'	8"	30	2	\$4,943.00	
BMK220102000	2000	20'	10"	24	2	\$4,398.00	
BMK220142000	2000	20'	14"	17	2	\$3,609.00	
BMK220152000	2000	20'	15"	16	2	\$3,298.00	
BMK220702010	2010	20'	7"	34	2	\$5,448.00	
BMK220752010	2010	20'	7.5"	32	2	\$5,258.00	
BMK220802010	2010	20'	8"	30	2	\$5,068.00	
BMK220102010	2010	20'	10"	24	2	\$4,498.00	
BMK220152015	2015	20'	15"	16	2	\$3,298.00	
BMK224602400	2400	24'	6"	48	2	\$6,974.00	
BMK224702400	2400	24'	7"	40	2	\$5,792.00	
BMK224752400	2400	24'	7.5"	38	2	\$5,735.00	
BMK224802400	2400	24'	8"	36	2	\$5,647.00	
BMK224102400	2400	24'	10"	28	2	\$5,757.00	
BMK224152400	2400	24'	15"	19	2	\$3,755.00	
BMK224752410	2410	24'	7.5"	38	2	\$5,790.00	
BMK224802410	2410	24'	8"	36	2	\$5,674.00	
BMK224102410	2410	24'	10"	28	2	\$4,841.00	
BMK224152410	2410	24'	15"	19	2	\$3,986.00	
BMK230753010	3010	30'	7.5"	48	2	\$6,814.00	
BMK230803010	3010	30'	8"	44	2	\$6,434.00	
BMK230103010	3010	30'	10"	36	2	\$5,674.00	
BMK230153010	3010	30'	15"	24	2	\$4,498.00	
BMK2247525F24	25F24	24'	7.5"	38	2	\$5,735.00	
BMK212603PD12	3PD12	12'	6"	24	1	\$3,398.00	
BMK212703PD12	3PD12	12'	7"	20	1	\$3,066.00	
BMK212753PD12	3PD12	12'	7.5"	19	1	\$2,971.00	
BMK212803PD12	3PD12	12'	8"	18	1	\$2,876.00	
BMK212103PD12	3PD12	12'	10"	14	1	\$2,496.00	

Great Plains Belt Meter Kits (Cont.)							
Product ID	Model	Width			Meters		Kit Prices
		Model	Spacing	Drives	Drives	Kit Prices	
BMK214083PD14	3PD14	14'	8"	20	1	\$3,066.00	
BMK214083PD14-1*	3PD14	14'	8"	20	1	\$3,066.00	
BMK215603PD15	3PD15	15'	6"	30	1	\$4,015.00	
BMK215703PD15	3PD15	15'	7"	26	1	\$3,628.00	
BMK215703PD15-1	3PD15	15'	7"	26	1	\$3,628.00	
BMK215753PD15	3PD15	15'	7.5"	24	1	\$3,398.00	
BMK215753PD15-1	3PD15	15'	7.5"	24	1	\$3,398.00	
BMK215803PD15	3PD15	15'	8"	22	1	\$3,256.00	
BMK215803PD15-1*	3PD15	15'	8"	22	1	\$3,256.00	
BMK215103PD15	3PD15	15'	10"	18	1	\$2,876.00	
BMK215153PD15	3PD15	15'	15"	12	1	\$2,307.00	
BMK220753PD20	3PD20	20'	7.5"	32	2	\$5,147.00	
BMK220803PD20	3PD20	20'	8"	30	2	\$4,943.00	
BMK220803PD20-1*	3PD20	20'	8"	30	2	\$4,943.00	
BMK220103PD20-1*	3PD20	20'	10"	24	2	\$4,398.00	
BMK220153PD20	3PD20	20'	15"	16	2	\$3,298.00	
BMK230702SF30	SF30	30'	7"	52	2	\$7,056.00	
BMK24580SS45	SS45	45'	8"	66	3	\$8,354.00	
BMK23075SS87	SS87	30'	7.5"	48	2	\$6,974.00	
BMK23015SS87	SS87	30'	15"	24	2	\$4,398.00	

\* With markers.

Case-IH Belt Meter Kits							
Product ID	Model	Width			Meters		Kit Prices
		Model	Spacing	Drives	Drives	Kit Prices	
BMK415705400	5400	15'	7"	26	1	\$3,777.00	
BMK415755400	5400	15'	7.5"	24	1	\$3,587.00	
BMK415805400	5400	15'	8"	22	1	\$3,397.00	
BMK415105400	5400	15'	10"	18	1	\$2,991.00	
BMK415155400	5400	15'	15"	12	1	\$2,422.00	
BMK420705400	5400	20'	7"	34	2	\$5,705.00	
BMK420755400	5400	20'	7.5"	32	2	\$5,515.00	
BMK420805400	5400	20'	8"	30	2	\$5,325.00	
BMK420105400	5400	20'	10"	24	1	\$3,587.00	
BMK420205400	5400	20'	20"	12	1	\$2,448.00	
BMK430705500	5500	30'	7"	52	2	\$7,426.00	
BMK430755500	5500	30'	7.5"	48	2	\$7,046.00	
BMK430105500	5500	30'	10"	36	2	\$5,907.00	
BMK415155400-11	5400SS	15'	15"	11	1	\$2,427.00	
BMK415155400-12	5400SS	15'	15"	12	1	\$2,448.00	
BMK420155400-14	5400SS	20'	15"	14	1	\$2,744.00	
BMK420155400-15	5400SS	20'	15"	15	1	\$2,839.00	
BMK420155400-16	5400SS	20'	15"	16	1	\$2,934.00	
BMK430155500	5500SS	30'	15"	24	2	\$4,916.00	

**IMPORTANT:** The S.I. Belt Meter is not designed nor will it work properly when planting soybeans that are larger than 2,000 actual seeds per pound. Soybeans must be properly graded so as to not contain soybeans that are larger than 2,000 actual seeds per pound. Larger beans such as tofu and edible beans generally will not work with the S.I. Belt Meter because of the size of the bean.

# YETTER 2968 FERTILIZER OPENER

## Step 1: Yetter 2968 Row-Unit Mount Fertilizer Opener (Single) See Chart to the Right for Step 2

Case-IH		10" Notched	10" Smooth	Price
1200	LH	YTR052131	YTR052141	\$500.00
	RH	YTR052132	YTR052142	\$500.00
2000* - For Box Planters Refer to Chart Below	LH	YTR050131	YTR050141	\$500.00
	RH	YTR050132	YTR050142	\$500.00
Harvest International		10" Notched	10" Smooth	Price
Laser-Pro	LH	YTR026131	YTR026141	\$405.00
	RH	YTR026132	YTR026142	\$405.00
John Deere		10" Notched	10" Smooth	Price
MaxEmerge (7000, 7100)	LH	YTR021131	YTR021141	\$405.00
	RH	YTR021132	YTR021142	\$405.00
MaxEmerge 2, MaxEmerge Plus, MaxEmerge XP, MaxEmerge 5, ExactEmerge	LH	YTR020131	YTR020141	\$405.00
	RH	YTR020132	YTR020142	\$405.00
Kinze		10" Notched	10" Smooth	Price
2000, 3000	LH	YTR021131	YTR021141	\$405.00
	RH	YTR021132	YTR021142	\$405.00
4900	LH	YTR027131	YTR027141	\$425.00
	RH	YTR027132	YTR027142	\$425.00
White		10" Notched	10" Smooth	Price
8000	LH	YTR022131	YTR022141	\$405.00
	RH	YTR022132	YTR022142	\$405.00
9000	LH	YTR025131	YTR025141	\$405.00
	RH	YTR025132	YTR025142	\$405.00



## Step 2: Single Opener Fertilizer Options

Description		Product ID	Price
Spring Loaded Knife	LH	YTR2968901	\$125.00
	RH	YTR2968902	\$125.00
Injection Kit		YTR2968091	\$25.00

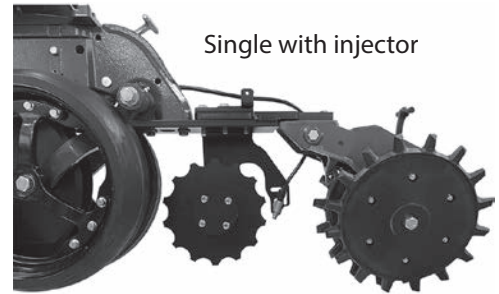

Single with injector

## Available as a dual or single-wheel opener

- Achieves consistent off-the-row placement for starter or liquid fertilizers
- Make quick adjustments between placement locations; options are 2" or 3" off the row
- Utilizes a 10" disc to open fertilizer slot
- Disc is located behind gauge wheel, eliminating fertilizer and damp soil buildup on gauge wheel
- Compact design makes planter installation quick and easy
- Adjust depth quickly with cordless impact or wrench
- Allows the use of other attachments on the front of the row unit
- Fits mounted and pull-type planters

## Step 2: Dual Opener Fertilizer Options

Description	Product ID	Price
Spring Loaded Knives	YTR2968992	\$250.00
Injection Kit	YTR2968912	\$50.00

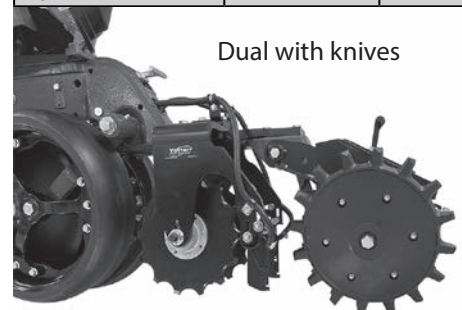

Dual with knives

## Step 1: Yetter 2968 Row-Unit Mount Fertilizer Opener (Dual) See Chart to the Right for Step 2

Case-IH		10" Notched	10" Smooth	Price
1200	LH lead opener	YTR053131	YTR053141	\$750.00
	RH lead opener	YTR053132	YTR053142	\$750.00
2000* - For Box Planters Refer to Chart Below	LH lead opener	YTR051131	YTR051041	\$750.00
	RH lead opener	YTR051132	YTR051042	\$750.00
Harvest International		10" Notched	10" Smooth	Price
Laser-Pro		YTR044133	YTR044143	\$650.00
John Deere		10" Notched	10" Smooth	Price
MaxEmerge (7000, 7100)		YTR041133	YTR041143	\$650.00
MaxEmerge 2, MaxEmerge Plus, MaxEmerge XP, MaxEmerge 5, ExactEmerge		YTR040133	YTR040143	\$650.00
Kinze		10" Notched	10" Smooth	Price
2000, 3000		YTR041133	YTR041143	\$650.00
4900		YTR045133	YTR045143	\$650.00
White		10" Notched	10" Smooth	Price
8000		YTR042133	YTR042143	\$650.00
9000		YTR043133	YTR043143	\$650.00

## Optional Equipment

Description	Product ID	Price
*Box Mount Kit for 2000 Series Case-IH Planters with boxes	YTR2968054	\$125.00

# YETTER 6200 FURROW MAX



The Furrow Max Closing System features multiple pressure settings that operate independently, and it helps overcome challenging planting conditions. First, closing discs successfully eliminate the compacted seed furrow sidewall, then they press soil firmly back around the seed. The pressing action of the firming wheel reduces air pockets, increasing crucial seed-to-soil contact and conserving moisture.



Furrow max with firming wheel

Step 1A: Furrow Max with firming wheel		
Harvest International	Product ID	Price
LaserPro	YTR620870	\$860.00
John Deere	Product ID	Price
MaxEmerge 2, ME Plus, ME Pro, XP, XP Pro, ME 5, EE, Black	YTR620870	\$860.00
MaxEmerge 2, ME Plus, ME Pro, XP, XP Pro, ME 5, EE, Green	YTR620070	\$860.00
Kinze	Product ID	Price
2000, 3000, Black	YTR620071	\$890.00
4900, Black	YTR620073	\$890.00
White	Product ID	Price
9000, Black	YTR620072	\$890.00

- Stage 1: Utilizes 8" smooth or serrated closing discs
- Stage 2: Utilizes 6.5" chevron-patterned firming wheel or V closing wheel attachment
- With true independent suspensions, firming wheel travels completely independently of the closing discs
- Offers four down pressure settings for closing discs and firming wheel
- Optional single or dual liquid fertilizer kit available

Step 1B: Furrow Max with V-Closing Wheels		
Description	Product ID	Price
MaxEmerge 2, ME Plus, ME Pro, XP, XP Pro, ME 5, EE, Black	YTR620080	\$460.00
MaxEmerge 2, ME Plus, ME Pro, XP, XP Pro, ME 5, EE, Green	YTR620880	\$460.00
*Closing wheels are not included in price*		



Furrow Max with V-closing wheels

Step 2: Furrow Max Closing Discs		
Description	Product ID	Price
8" Serrated Discs	YTR600013	\$120.00
8" Smooth Discs	YTR600017	\$120.00

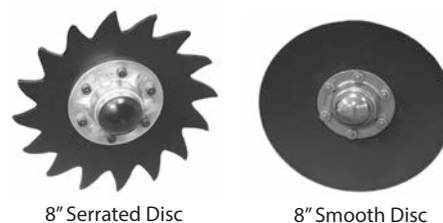

8" Serrated Disc

8" Smooth Disc

Step 3 Optional: Fertilizer Add-On Kit		
Description	Product ID	Price
LH Liquid Kit	YTR620085	\$40.00
RH Liquid Kit	YTR620885	\$40.00



Furrow Max w/ Fertilizer

# YETTER FARM EQUIPMENT

Since 1930, Yetter Farm Equipment has delivered innovative, profit-driven solutions for production agriculture. With a broad lineup of proven planting and harvesting tools, Yetter continues to support growers with equipment that drives success in the field.



**Yetter N-Keepers**



**Yetter Cover Crop Roller**

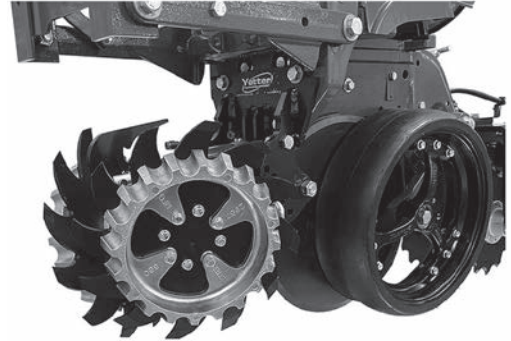

**Yetter Row Cleaners**

Replacement Parts for Yetter Residue Managers			
Parts for 8 Bolt Hub Built Oct 2021 & After	Vendor ID	Product ID	Price
Hub & Bearing Assembly, 2.812" D-Bolt	2965-500	YTR2965500	\$90.85
Hub & Bearing Assembly, 3.812" D-Bolt	2965-501	YTR2965501	\$90.85
13" Taper Tooth Wheel	2571-289	YTR2571289	\$85.00
13" Bevel Wheel, LH	2571-287-L	YTR2571287	\$103.00
13" Bevel Wheel, RH	2571-287-R	YTR2571887	\$103.00
13" Sharktooth Wheel	2571-286	YTR2571286	\$85.00
13" Sharktooth Finger Wheel	2571-600	YTR2571600	\$85.00
Bearing	2965-606	YTR2965606	\$31.32
Poly Floater Wheel for Sharktooth Wheel	2967-175	YTR2967175	\$55.00
Poly Floater Wheel for Sharktooth Finger Wheel	2967-188	YTR2967188	\$55.00
Floater Wheel, Aluminum	2967-186A	YTR2967886	\$55.00
Parts for 4 Bolt Hub Built Before Oct 2021	Vendor ID	Product ID	Price
Hub Cap	2965-352	YTR2965352	\$16.97
13" Taper Tooth Wheel	2967-404	YTR2967404	\$81.95
13" Bevel Wheel, LH	6200-350	YTR6200350	\$81.95
13" Bevel Wheel, RH	6200-351	YTR6200351	\$81.95
13" Sharktooth Wheel	2967-602	YTR2967602	\$45.00
13" Sharktooth Wheel, IF Hardox 500	IF2AA73405	IHL273405	\$72.00
13" Sharktooth Finger Wheel	2571-601	YTR2571601	\$85.00
Bearing	2570-594	YTR2570594	\$23.83
Bearing Insert	2570-715	YTR2570715	\$10.02
Hub	2965-351	YTR2965351	\$37.32
Seal	2550-069	YTR2550069	\$7.96
Floater Wheel, Aluminum	2967-186	YTR2967186	\$55.00
Hub & Bearing Assembly	2965-128	YTR2965128	\$102.13
HHCS, 5/8-11 X 3.812", GR8, Spindle Bolt	2570-742	YTR2570742	\$8.38
HHCS, 5/8-11 X 2.812", GR8, Spindle Bolt	2570-740	YTR2570740	\$7.33



**YTR2967886**



**YTR2967186**



**YTR2965128**



**YTR2967188**



**YTR2965500**



**YTR2967175**

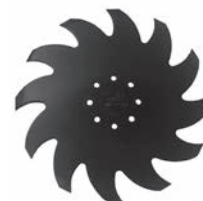

**YTR2571286**



**YTR2571600**

# OEM REPLACEMENT PARTS

Standard Profile Gauge Wheel Tires			
3/8" Flange			
Size	Brand	Product ID	Price
4.5" x 16"	OEM Replacement	PLT453811	\$39.95
	Otico	OTC084050	\$60.83
7/8" Flange (XP Style)			
Size	Brand	Product ID	Price
4.5" x 16"	OEM Replacement	PLT457811	\$39.95
	Otico	OTC084062	\$60.83
	MudSmith	MSW445000	\$55.00
3" x 16"	OEM Replacement	PLT307811	\$34.95
	Otico	OTC098188	\$39.00
	MudSmith	MSW331000	\$55.00

RID Profile Gauge Wheel Tires			
3/8" Flange			
Size	Brand	Product ID	Price
4.5" x 16"	OEM Replacement	PLT453821	\$42.95
	Otico	OTC087604	\$62.00
7/8" Flange (XP Style)			
Size	Brand	Product ID	Price
4.5" x 16"	OEM Replacement	MRT003731	\$46.95
	MudSmith	MSW446000	\$60.00
3" x 16"	MudSmith	MSW333000	\$60.00



4.5" x 16" RID



4.5" x 16" Standard Profile



PLT411359



PLT007949



PLT457811



PLT411864



Standard Tire



RID Tire

Gauge Wheel Assemblies							
Great Plains	Size	Profile	Bearing	Description	Product ID	Price	
Great Plains	4.5" x 16"	Standard	5/8" or 16mm	Solid	PLT866604	\$95.95	
	4.5" x 16"	Standard	5/8" or 16mm	Spoke	PLT880450	\$110.00	
	3" x 16"	Standard	5/8" or 16mm	Spoke	PLT880300	\$110.00	
John Deere	Size	Profile	Bearing	Description	Product ID	Price	
MaxEmerge, Early MaxEmerge 2	4.5" x 16"	Standard	Roll Pin	Solid	PLT432046	\$83.95	
Late MaxEmerge 2, MaxEmerge Plus, MaxEmerge Pro, 1530, 1535 with Plus	4.5" x 16"	Standard	Set Screw	Solid	PLT411359	\$110.00	
750, 1850	4.5" x 16"	Standard	5/8" or 16mm	Solid	PLT411864	\$83.95	
MaxEmerge XP, Pro-Series XP, MaxEmerge 5, ExactEmerge, 1530, 1535 with XP, 750, 1560, 1565, 1590, 1690, 1835, 1850, 1860, 1890, 1895, 1990	4.5" x 16"	Standard	5/8" or 16mm	Solid	PLT866604	\$95.95	
				Spoke	PLT880450	\$110.00	
	3" x 16"	Standard	5/8" or 16mm	Spoke	PLT880300	\$110.00	
Kinze	Size	Profile	Bearing	Description	Product ID	Price	
2000 series 1993 and newer	4.5" x 16"	Standard	5/8" or 16mm	Solid	PLT866604	\$99.95	
3000, 4000, 5000 series	4.5" x 16"	Standard	5/8" or 16mm	Solid	PLT007949	\$147.40	
2000, 3000, 4000, 5000 series	4.5" x 16"	Standard	5/8" or 16mm	Spoke	PLT880450	\$110.00	
				Spoke	PLT880300	\$110.00	
3" x 16"	Standard	5/8" or 16mm	Spoke	PLT880300	\$110.00		
White/Massey Ferguson	Size	Profile	Bearing	Description	Product ID	Price	
6000 Series	4.5" x 16"	Standard	Set Screw	Solid	PLT411359	\$110.00	
8000, 9000 series	4.5" x 16"	Standard	5/8" or 16mm	Solid	PLT866604	\$95.95	
				Spoke	PLT880450	\$110.00	
	3" x 16"	Standard	5/8" or 16mm	Spoke	PLT880300	\$110.00	

# PLANTING OEM REPLACEMENT PARTS



## Gauge Wheel Arm Kits

John Deere	Description	Product ID	Price
7000/7100 MaxEmerge	Mounts on 1" diameter pin, wheel mounts with M16 bolt ( must convert gauge wheels to bolt on style bearing) (Painted Black)	PLT106614	\$31.95
MaxEmerge XP, MaxEmerge 5, & Exact Emerge	Mounts with 16mm x 100mm bolt, wheel mounts with M16 bolt	PLT192817	\$31.95
Kinze	Description	Product ID	Price
2000 Series 1993-1999	Mounts on 1" diameter pin, wheel mounts with M16 bolt	PLT106614	\$31.95
3000 & 4000 Series	Left Hand Arm, Direct OEM replacement	PLT007975	\$48.40
	Right Hand Arm, Direct OEM replacement	PLT007976	\$49.10

## Gauge Wheel Arm Replacement Bushings

Description	Product ID	Price
Self Aligning Bushing, 1" inside diameter Used in PLT106614 arms	PLT197867	\$9.95
Self Aligning Bushing, 16mm (5/8") inside diameter Used in PLT192817 arms. Will NOT work in OEM arm	PLT192818	\$9.95
Full Thread Self Aligning Bushing, 16mm (5/8") inside diameter, John Deere: A57058 A92818 Replacement	PLT154179	\$9.95

## Closing Wheel Bracket Replacement Parts

John Deere	Description	Product ID	Price
Eccentric Bushing	OEM Replacement for 1/8" thick ears, 1" I/D round holes	PLT120550	\$2.39
	OEM Replacement for 1/4" hardened ears, 1" I/D round holes	PLT120650	\$5.95
	For hex style ears with hex step bushing	PLT120660	\$3.95
Hex Step Bushing	Hex step bushing, for use with PLT120660 eccentric bushing	PLT120661	\$1.95
T-handle	For SI closing wheel frames or OEM Replacement, John Deere MaxEmerge (7000, 7100), (Green)	PLT120750	\$9.50
	OEM Replacement, John Deere MaxEmerge Plus, Pro, XP, XP Pro, ME 5, EE	PLT864237	\$11.95
Spring	For SI closing wheel frames or OEM Replacement, John Deere MaxEmerge (7000, 7100)	PLT120751	\$8.50
	OEM Replacement, John Deere MaxEmerge Plus, Pro, XP, XP Pro, ME 5, EE	PLT857290	\$12.35
Closing Wheel Bracket Stop	OEM Replacement with reinforced spring hole. John Deere MaxEmerge Plus, Pro, XP, XP Pro, ME 5, EE	PPS025624	\$43.00
Kinze	Description	Product ID	Price
Closing Wheel Bracket Kit (includes hardware)	For roll pin attached closing wheels, Kinze 2000 series (early).	PLT120710	\$69.95
	For bolt-on closing wheels. Kinze 2000, 3000, 4000 series. (Early 2000 series must convert to bolt on style closing wheels)	PLT120720	\$67.95
Closing Wheel Bracket	For bolt-on closing wheels, Kinze 2000 (late), 3000, 4000 series.	PLT120761	\$36.95
Eccentric Bushing	OEM Replacement for 1/8" thick ears, 1" I/D round holes	PLT120550	\$2.39
	OEM Replacement for 1/4" hardened ears, 1" I/D round holes	PLT120650	\$5.95
	For hex style ears with hex step bushing	PLT120660	\$3.95
Hex Step Bushing	Hex step bushing, for use with PLT120660 eccentric bushing	PLT120661	\$1.95
T-handle	For SI closing wheel frames or OEM Replacement, Kinze 2000, 3000, 4000 Series, (Black)	PLT120753	\$9.50
Spring	For SI closing wheel frames or OEM Replacement, Kinze 2000, 3000, 4000 Series	PLT120751	\$8.50

# PLANTING OEM REPLACEMENT PARTS

## FOR PLANTERS AND SEEDERS/DRILLS

### Case-IH Closing Wheels

Case-IH	Description	Product ID	Price
Late 800, 900, 1200 series	8" Shark Tooth Closing Disc Assembly, LH	WPT112778	\$40.81
	8" Shark Tooth Closing Disc Assembly, RH	WPT212788	\$40.81
1200, 2100 series	Press Wheel Assembly, 5/8" ID bearing	MRT800419	\$98.00



WPT212788



MRT800419

### Closing Wheels

Wheel	Bearing Type	Product ID	Price
12" Cast	Roll Pin	PLT110000	\$59.00
12" Rubber	Roll Pin	PLT043899	\$38.95
	17mm (stud mount)	PLT043898	\$38.95
	5/8"/16mm (bolt mount)	PLT039970	\$38.95



PLT039970



PLT110000



PLT043899



PLT043898

### Seed Tube Guards/Inner Scrapers

John Deere	Product ID	Price
MaxEmerge, MaxEmerge 2, MaxEmerge Plus, MaxEmerge Pro	PLT061577	\$11.95
MaxEmerge XP, Pro-Series XP, MaxEmerge 5	PLT080203	\$11.95
Kinze	Product ID	Price
2000 Series	PLT061577	\$11.95
3000 series	PLT000302	\$11.95



PLT000302



PLT061577



PLT080203

### Seeder/Drill Seed Boots

John Deere	Description	Product ID	OEM#	Price
750, 1850	right hand	DRL280446	N280446	\$49.95
	left hand	DRL280447	N280447	\$49.95

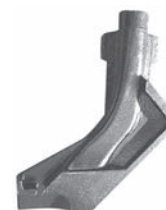

DRL280446



DRL280447

### Replacement Gauge Wheel & Closing Wheel Bearings

Description		Product ID	Price
Roll Pin	with sleeve	PLT035951	\$9.95
	without sleeve	PLT110001	\$8.95
Set Screw	with sleeve	PLT838106	\$8.95
	without sleeve	PLT885154	\$9.95
17mm	outside bearing, 1 per wheel	PLT110011	\$8.95
	inside bearing, 1 per wheel	PLT110022	\$10.95
5/8" or 16mm	Standard	PLT110250	\$9.95
	Peer SeedXtreme	PLT110025	\$22.95



PLT035951  
Bearing  
with Sleeve



PLT838106  
Bearing with  
Sleeve



PLT110250



PLT110011



PLT110022

*Specially formulated boron steel outwears leading competitors.*



#WPT926054

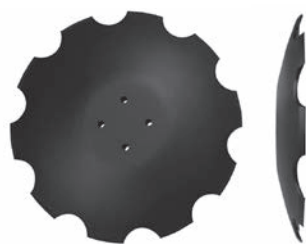

#WPT926566

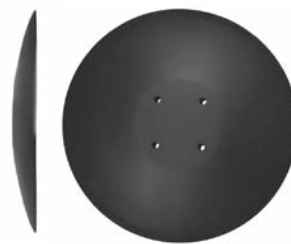

#WPT996566

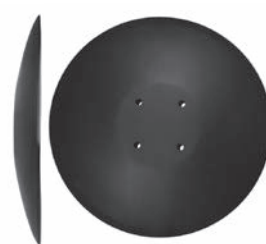

#WPT996554



The **Celsan blade** is single heat-treated, highly durable and made of high manganese steel that averages 15-20% longer life over standard blades. It is powder-coated to provide a lasting surface finish.

Wearparts High Speed Compact Disc Blades					
Model	Diameter	Thickness	Blade Type	Blade ID	Price
<b>Case-IH, K-Line</b>					
Speed-Tiller, Speedtiller	22"	6mm	Notched	WPT936005	\$80.28
	24"	6.5mm	Notched	WPT956506	\$127.06
<b>Degelman, Harvest International, Kinze</b>					
Pro-Till, Mach Till, Command Till	20"	6.5mm	Notched	WPT926554	\$84.77
	20"	6.5mm	Smooth	WPT996554	\$81.83
	22"	6mm	Smooth	WPT933606	\$109.77
	22"	6.5mm	Notched	WPT936542	\$111.48
	22"	6.5mm	V-Notched	WPT996542	\$126.86
<b>Horsch</b>					
Joker	20"	6mm	Notched	WPT926054	\$74.38
	18" - LH	8mm	Star	WPT959507	\$90.42
	18" - RH	8mm	Star	WPT959508	\$85.91
<b>John Deere, Norwood</b>					
2680H, Kwik-Till	20"	6.5mm	Notched	WPT926566	\$84.77
	20"	6.5mm	Smooth	WPT996566	\$81.83
<b>Kuhn</b>					
Optimer	22"	5mm	Notched	WPT935066	\$91.35
<b>Landoll</b>					
HSL	24"	6.5mm	Notched	WPT956569	\$131.49
<b>Lemken</b>					
Helliodor	18"	5mm	Notched	WPT915065	\$62.32
	20"	5mm	Notched	WPT925064	\$82.55
Rubin 9	24"	6mm	Notched	WPT956069	\$113.49
	30"	6mm	Notched	WPT996069	\$159.60
Rubin 10	25.4"	6mm	Notched	WPT966069	\$143.02
<b>Poettinger</b>					
Terradisc	23"	5mm	Notched	WPT945066	\$102.08
<b>Versatile</b>					
Fury	24.6"	8mm	Notched	WPT958053	\$194.37
	24.6"	8mm	Smooth	WPT998753	\$188.80

## High-Speed Hubs/Bearings: Maintenance-Free and Durable

Model	Bearing/Hub ID	Price
<b>Amazone</b>		
Catros	WPT090012	\$160.55
<b>Degelman, Harvest International, Kinze</b>		
Pro-Till, Mach Till, Command-Till	WPT090000	\$156.22
<b>Horsch</b>		
Joker	WPT090006	\$146.02
<b>John Deere, Norwood</b>		
2680H, Kwik-Till	WPT090007	\$141.22
<b>Kverneland</b>		
Standard Disc Harrow	WPT090008	\$131.97
<b>Kuhn</b>		
Optimer	WPT090011	\$134.63
<b>Lemken</b>		
Helliodor - LH	WPT090002	\$181.42
Helliodor - RH	WPT090003	\$181.42
Rubin 9 - LH	WPT090004	\$211.31
Rubin 9 - RH	WPT090005	\$222.43
<b>Poettinger</b>		
Terradisc	WPT090010	\$177.20
<b>Vaderstad</b>		
Carrier	WPT090001	\$114.69
<b>Versatile</b>		
Fury	WPT090007	\$141.22



#WPT090000



#WPT090006



#WPT090007

# VERTICAL TILLAGE BLADES



- Razor Edge
- Double Bevel
- Reverse Crimp Center
- Thickness: 5mm & 6.5 mm

## 3 ZONES OF HARDNESS

- 1 Increased Flexibility**  
(49-50 HRC)
- 2 Increased Durability**  
(50-55 HRC)
- 3 Maximum Wear**  
(55-58 HRC)

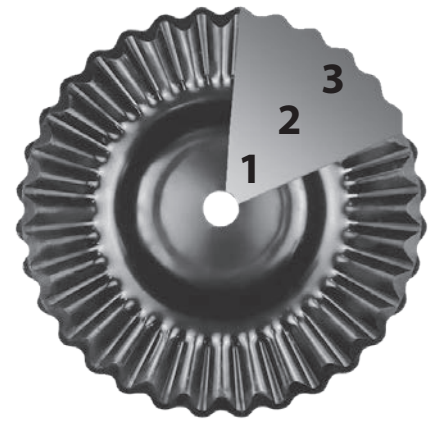

Wearparts Vertical Tillage Blades							
Model	Diameter	Thickness	OEM ID	FDN 200	Price	Celsan	Price
<b>Case-IH</b>							
330, 335 - Right Front, Left Rear	20"	6.5mm	87630572, 47654438	-	-	WPT926557	\$87.97
330, 335 - Left Front, Right Rear	20"	6.5mm	87630573, 47654439	-	-	WPT996557	\$87.97
<b>Great Plains</b>							
Turbo-Till	20"	5mm	820-261C	-	-	WPT925040	\$69.95
Turbo-Till, Turbo-Max, Turbo Chopper, Verti-Till	20"	6.5mm	820-011C, 820-261C	WPT126540	\$136.66	WPT926540	\$85.77
Turbo Chisel	22"	6.5mm	820-430C	-	-	WPT936540	\$106.69
<b>John Deere</b>							
2660VT	22"	6.5mm	KK89792	WPT136573	\$165.60	WPT936573	\$116.49
<b>Krause</b>							
Excellerator 8000 series	22"	6.5mm	Q8014420, 30-257	WPT136570	\$165.60	WPT936570	\$128.14
<b>Landoll</b>							
7000 Series	22"	6mm	155617	-	-	WPT936010	\$82.66
	24"	6mm	155617	-	-	WPT956010	\$102.66
<b>McFarlane</b>							
Reel Disc	20"	5mm	RD4477	-	-	WPT926056	\$85.18
<b>Sunflower</b>							
6000 Series	22.25"	5mm	SN16844	WPT135058	\$143.55	WPT935058	\$90.29
*Call for price and availability							

## SMART-TILL PARTS

S.I. Distributing stocks replacement tines, bearings and other wear items for the Smart-Till residue management tool.

Smart-Till Replacement Parts		
Description	Product ID	Price
Tine, Left Hand Carriage, Casting Mark: LF/RR	HCC231250	\$34.65
Tine, Right Hand Carriage, Casting Mark: RF/LR	HCC231251	\$34.65
Tine Bolt (two required per tine)	HCC202925	\$2.80
Tine Lock Nut (two required per tine)	HDW212500	\$1.22
Heavy Duty Spindle & Hub Assembly	HCC226334	\$178.64
Pillow Block Housing	HCC243748	\$58.50
Pillow Block Bearing	HCC243749	\$80.50
Roller Thrust Plate	HCC553001	\$6.88
C-Flex, 1" x 3", 3-Hole, For 2010 and newer models; serial number beginning with 310xxx	HCC553237	\$131.41
C-Flex, 1" x 3", 4-Hole, For 2009 and earlier models; serial number prior to 310xxx	HCC553183	\$136.95
Rock Guard	HCC553238	\$62.92
Rock Guard Retainer	HCC553239	\$8.80

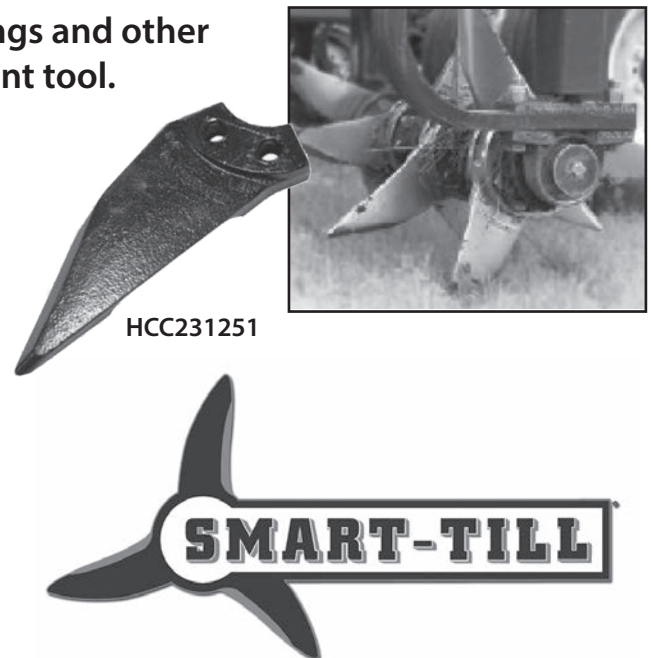

# RADURA DISC MOWER BLADES

Superior Performance and Safety,  
and INCREASES SERVICE LIFE.



**PROBLEM:** Disc mower blades, that are prematurely worn and weakened, as well as being chipped, provide inferior cutting quality.

**SOLUTION:** The design and precise craftsmanship of Radura disc mower blades provide superior performance and safety, and increases service life.

**Competitor's blade - 63 hours**



**Radura blade - 63 hours**



## A Very Affordable Upgrade!

**radura®**  
Highest Quality  
Replacement Parts  
Priced Right for Your Operation



**Unique Cold Rolled Cutting Edges are more wear resistant than ground or shaved edges. They also offer more stability.**

*The competition's edge feels sharp but wears much faster than a rolled edge.*

**Radura Cold Rolled Edge**



**Competition's Grounded Edge**



**Radura disc mower blades have been used to cut hay, alfalfa and grass for over 50 years.**

The Radura blade features a **cold rolled cutting edge**, whereas most other competitors grind their cutting edge. This grinding method weakens the steel and causes the blade to chip and wear prematurely. **With the special cold rolled process** used on the cutting edge of the Radura blade, the results are a **more wear-resistant edge that maintains its sharpness longer**. Each batch of Radura rotary disc mower blades is subjected to a rigorous quality control program, ensuring they meet DIN 11250 / ISO 5718-2 standards.



- Superior Cutting Quality
- Precise Quality Control for Performance and Safety
- Increased Service Life

# RADURA DISC MOWER BLADES

Radura Disc Mower Blades								
	Left	Right	Angle	Bevel	Shape	Price	Bolt	Nut
<b>AGCO</b>								
3006, 3007, 3008, 3009, 3010, 3309	RSP042059	RSP042057	11°	Top	10	\$2.33	RSP042134	RSP051061
	RSP052698	RSP052697	18°	Top	10	\$2.66		
3312, 3315, 9170, 9180, 9190, 9192	RSP042022	RSP042026	10°	Both	9	\$1.88	RSP052668	RSP052669
	RSP042031	RSP042030	11°	Bottom	10	\$2.16		
	RSP042011	RSP042010	11°	Top	10	\$2.37		
	RSP042050	RSP042049	18°	Bottom	10	\$2.14		
	RSP052497	RSP052498	18°	Top	10	\$2.54		
<b>Bush Hog</b>								
DM7, DM8, DM9, DM18, DM19, HM5, HM7, HM8	RSP042064	RSP042066	11°	Top	10	\$2.01	RSP052234	RSP052235
DM70, DM80, DM90, DM180, DM190, DM5406, DM5407, DM5408, DM5409	RSP042059	RSP042057	11°	Top	10	\$2.33	RSP042134	RSP051061
	RSP052698	RSP052697	18°	Top	10	\$2.66		
<b>Case-IH</b>								
725, 8309, 8312, 8315, 8850, DC515	RSP042022	RSP042026	10°	Both	9	\$1.88	RSP052668	RSP052669
	RSP042031	RSP042030	11°	Bottom	10	\$2.16		
	RSP042011	RSP042010	11°	Top	10	\$2.37		
	RSP042050	RSP042049	18°	Bottom	10	\$2.14		
	RSP052497	RSP052498	18°	Top	10	\$2.54		
DC92, DC92F, DC132, DC132F, DC162, DC162F, DX91, DCX101, DCX131, DCX131F, DCX161, RD132, RD162, RD182, RDX131, RDX161, RDX181, TD102, MD72, MD82, MD92, MDX71, MDX81, MDX91	RSP042056	RSP042055	7°	Top	10	\$2.29	w/o lifters RSP052673, w/ lifters RSP052939	RSP052674
	RSP041986	RSP041987	14°	Top	10	\$2.43		
DC93, DC103, DC133, DC163, RD193, RD163	RSP343225	RSP343226	7°	Top	10	\$2.91	w/o lifters RSP052673, w/ lifters n/a	RSP052674
	RSP255700	RSP255699	14°	Top	10	\$2.91		
	RSP271205	RSP271203	18°	Top	10	\$2.91		
3204 (SD), 3205 (SD), 3206 (SD), 3309 (SD)	RSP042064	RSP042066	11°	Top	10	\$2.01	RSP052234	RSP052235
3204 (HD), 3205 (HD), 3206 (HD), 3309 (HD)	RSP042056	RSP042055	7°	Top	10	\$2.29	n/a	n/a
	RSP052698	RSP052697	18°	Top	10	\$2.66		
DC101F, DC102, DC102F, DC103, DC132, DC132F, DC162, DC162F, DC92, DC92F, DC93, DCX101, DCX131, DCX131F, DCX161, DCX91, MD72, MD73, MD82, DM92, MD93, MDX71, MDX81, MDX91, RD132, RD16, RD182, RDX131, RDX161, RDX181, TD102, TD103	RSP054144	RSP054142	7°	Top	10	\$3.99	n/a	n/a
	RSP054136	RSP054133	14°	Top	10	\$4.31		
<b>Challenger</b>								
9195, 9196, 9283, 9286, 9295, 9296, DKH12, DKH15, DKHB, DKHC, DKHCT, DKHD, DKHDT, DKHE, DKHET, PTD10, PTD10B, PTD12, PTD12B, PTD15, PTD15B	RSP042022	RSP042026	10°	Both	9	\$1.88	RSP052668	RSP052669
	RSP042031	RSP042030	11°	Bottom	10	\$2.16		
	RSP042011	RSP042010	11°	Top	10	\$2.37		
	RSP042050	RSP042049	18°	Bottom	10	\$2.14		
	RSP052497	RSP052498	18°	Top	10	\$2.54		
HTD7, HTD7B, HTD8, HTD8B, HTD9, HTD9B, PTD9	RSP042059	RSP042057	11°	Top	10	\$2.33	RSP042134	RSP051061
	RSP052698	RSP052697	18°	Top	10	\$2.66		
1316S, 1373, 1376, 1393, 9313D, 9313S, 9316D, 9316S	RSP002500	RSP002400	11°	Top	10	\$2.57	RSP060022	RSP219970
	RSP002300	RSP002200	11°	Bottom	10	\$2.57		
	RSP009040	RSP008040	18°	Top	10	\$2.69		
	RSP002700	RSP002600	18°	Bottom	10	\$2.57		
<b>Claas</b>								
210, 250, 260, 290, 300, 340, 1100, 2650, 2700, 2750, 2800, 3000, 3050, 3100, 3200, 3450, 3500, 3550, 3600, 3900, 4000, 8400, 8500, 8550, 8600, 8700, 9100, 9200, 9300, 9400	RSP042015	RSP042014	10°	Top	10	\$2.35	n/a	n/a
<b>Deutz-Fahr</b>								
KM20, KM22, KM24, KM25, KM25F, KM2.17, KM2.19, KM2.33, KM222, KM252	RSP041864		Flat	Both	1	\$1.06	RSP042096	RSP042093
	RSP041870		Flat	Both	3	\$1.34		
	RSP041874		Flat	Both	1	\$0.92		
KM2.27, SM40, SM45, SM50, SM50F, SM55F	RSP041888	RSP041887	15°	Both	9	\$1.66	n/a	n/a
<b>Fella</b>								
SM165, SM206, SM215, SM216, SM240	RSP042018	RSP042019	10°	Top	10	\$2.24	n/a	n/a
SM120	RSP042064	RSP042066	11°	Top	10	\$2.01	RSP42096	RSP45702
KM20, KM22	RSP041864		Flat	Both	1	\$1.06	n/a	n/a

Continued on next page

Shape Reference:

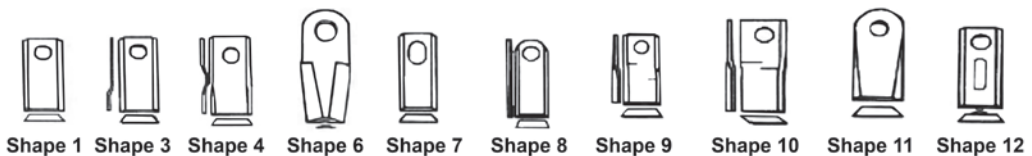

Visit our website for the most current product pricing [www.sidist.com](http://www.sidist.com)

# RADURA DISC MOWER BLADES

## Radura Disc Mower Blades (Continued)

	Left	Right	Angle	Bevel	Shape	Price	Bolt	Nut
<b>Gehl</b>								
162 (SD)	RSP041926	RSP041928	10°	Both	9	\$1.64	RSP042104	RSP042093
1162, 1165, DC2345, DC2365, DC2412, DC2415, DC2418	RSP042022	RSP042026	10°	Both	9	\$1.88	RSP042122	RSP053367
162(HD), 165, 2340 (BSN7602), 2360 (BSN7602), DC2340, DC2360	RSP042034	RSP042037	10°	Both	9	\$2.27	RSP042122	RSP053367
2310, DC2330 (BSN2227), DC1080, DC2350, DM140, DM160	RSP042064	RSP042066	11°	Top	10	\$2.01	RSP042096	RSP045702
<b>Hesston</b>								
870, 1320, 1340, 1345, 1355, 1360, 1365, 1375, 3312, 3315, 8070, 8500, 9070, 9075, 9080, 9170, 9180, 9183, 9185, 9190, 9192, 9195, 9196	RSP042022	RSP042026	10°	Both	9	\$1.88	RSP052668	RSP052669
	RSP042031	RSP042030	11°	Bottom	10	\$2.16		
	RSP042011	RSP042010	11°	Top	10	\$2.37		
	RSP042050	RSP042049	18°	Bottom	10	\$2.14		
	RSP052497	RSP052498	18°	Top	10	\$2.54		
1004, 1005, 1006, 1007, 1008, 3006, 3007, 3008, 3009, 3010, 3309	RSP042059	RSP042057	11°	Top	10	\$2.33	RSP042134	RSP051061
	RSP052698	RSP052697	18°	Top	10	\$2.66		
1030, 1040, 1050, 1060	RSP041978	RSP041979	11°	Top	10	\$1.78	N/A	N/A
<b>Frontier</b>								
DM1140, DM1150, DM1160, DM1270	RSP042034	RSP042037	10°	Both	9	\$2.27	RSP042122	RSP053367
<b>John Deere</b>								
240, 260, 1314, 1315, 1320 (Std. Disc), 1326 (Std. Disc), 1327 (Std. Disc)	RSP041926	RSP041928	10°	Both	9	\$1.64	RSP042104	RSP042093
1314, 1315	RSP041879	RSP041882	11°	Both	9	\$1.30	n/a	n/a
265 (BSN150001), 275 (BSN152001), 1350, 1360, 1460, 1470	RSP042022	RSP042026	10°	Both	9	\$1.88	RSP042122	RSP053367
500R, 525, 530, 535, 625, 630, 635, 730, 735, 830, 835, 915, 916, 925, 926, 935, 936, 945, 946, 955, 956, 990, 994, 995	RSP042022	RSP042026	10°	Both	9	\$1.88	RSP052670	RSP052671
	RSP308234	RSP308235	18°	Both	9	\$2.05		
265 (ASN150001), 270, 275 (ASN152001), 285 (check blade length), 1320 (HD Disc), 1326 (HD Disc), 1327 (HD Disc), R160, R200, R240, R280, R310	RSP042034	RSP042037	10°	Both	9	\$2.27	RSP042122	RSP053367
1320 (HD Disc), 1326 (HD Disc), 1327 (HD Disc)	RSP042074		Dome	Both	4	\$3.37	RSP042122	RSP053367
<b>Krone</b>								
AM203, AM243, AFA243, AM283, AFA283, AFL283, AMT283, AM323, AMT323, AM403, Big M, Big Mill	RSP041974	RSP041973	10°	Top	10	\$1.99	n/a	n/a
AM167, AM202, AM242, AM282, AFA243RS, AFA283RS, AFA323RS, AFL-243CV, AFL283CV, AFL243RS, AFL283RS, AFL323RS, AFL343RS, AM203S, AM243S, AM283S, 323S, AM243RS, AMT	RSP042051	RSP042052	7°	Top	10	\$1.99	RSP042128	RSP042109
<b>Kuhn</b>								
FC44, FC55, GMD33, GMD44, GMD55, GMD66, GMD77	RSP041926	RSP041928	10°	Both	9	\$1.64	RSP042104	RSP042093
	RSP041879	RSP041882	11°	Both	9	\$1.30		
	RSP041889		Flat	Both	1	\$1.54		
GMD283TG, GMD313TG, GMD400, GMD500, GMD600, GMD600GII, GMD700, GMD700GII, GMD702, GMD800, GMD800GII, GMD802, GMD802F, GMD883, GMD2850TL, GMD3150TL, GMD3550TL, GMD4050TL, FC200, FC202, FC240P, FC243, FC243RTG, FC243TG, FC250, FC280, FC280F, FC280P, FC280RTG, FC280TG, FC283, FC300, FC301, FC302, FC303, FC313, FC313F, FC350, FC352, FC353, FC813, FC883, FC4000, Alterna 400, Alterna 500	RSP042022	RSP042026	10°	Both	9	\$1.88	RSP042122	RSP053367
GMD44HD, GMD55HD, GMD66HD, GMD77HD, GMD240HD, GMD280HD, GMD310HD, GMD600HD, GMD600GIIHD, GMD700HD, GMD700GIIHD, GMD800HD, GMD800GIIHD	RSP042034	RSP042037	10°	Both	9	\$2.27	RSP042122	RSP053367
	RSP042035		Flat	Both	1	\$2.27		
GMD16, GMD20, GMD24, GMD28 s/n A1633 to A9999	RSP053400	RSP053401	11°	Both	9	\$2.03	n/a	n/a
FC2860, FC3160, FC3560, FC4060, FC3525DF, FD10030, GMD3151TL, GMD3510, GMD3525F, GMD3551TL, GMD4051TL, GMD5251TC, GMD10030	RSP053728	RSP053729	11°	Bottom	10	\$3.72	n/a	n/a
<b>Lely</b>								
Optimo 165, Optimo 205, Optimo 240, Optimo 280, Splendimo 320	RSP042064	RSP042066	11°	Top	10	\$2.17	n/a	n/a
<b>MacDon</b>								
R116	RSP052216	RSP052215	11°	Top	10	\$2.40	n/a	n/a
<b>Massey Ferguson</b>								
408, 411, 412, 415, 1345, 1355, 1363, 1365, 1366, 1372, 1375, 1383, 1386, 9070, 9075, 9080, 9175, 9183, 9185, 9186, 9190, 9192, 9195, 9196, 9283, 9295, 9296	RSP042022	RSP042026	10°	Both	9	\$1.88	RSP052668	RSP052669
1345, 1355, 1363, 1365, 1366, 1372, 1375, 1383, 1386, 9070, 9075, 9080, 9175, 9183, 9185, 9186, 9190, 9192, 9195, 9196, 9283, 9286, 9295, 9296	RSP042031	RSP042030	11°	Bottom	10	\$2.16	RSP052668	RSP052669
	RSP042011	RSP042010	11°	Top	10	\$2.37		
	RSP042050	RSP042049	18°	Bottom	10	\$2.14		
	RSP052497	RSP052498	18°	Top	10	\$2.54		

# RADURA DISC MOWER BLADES

## Radura Disc Mower Blades (Continued)

	Left	Right	Angle	Bevel	Shape	Price	Bolt	Nut
<b>Massey Ferguson (Continued)</b>								
1306, 1307, 1308, 1309, 1310, 1326, 1327, 1328, 1329, 1330, 1339, 1359, 5209 (SN>16012), 5212 (SN>16012), 5312, 5406, 5407, 5408, 5409, 5410	RSP042059	RSP042057	11°	Top	10	\$2.33	RSP042134	RSP051061
	RSP052698	RSP052697	18°	Top	10	\$2.66		
1316S, 1373, 1376, 1393, 9313D, 9313S, 9316D, 9316S	RSP002500	RSP002400	11°	Top	10	\$2.57	RSP060022	RSP219970
	RSP002300	RSP002200	11°	Bottom	10	\$2.57		
	RSP009040	RSP008040	18°	Top	10	\$2.69		
	RSP002700	RSP002600	18°	Bottom	10	\$2.57		
127	RSP042064	RSP042066	11°	Top	10	\$2.01	n/a	n/a
<b>New Holland</b>								
442 (BSNZ4750), 452, 462 (BSNZ1643)	RSP041879	RSP041882	11°	Both	9	\$1.30	RSP042104	RSP042093
442 (ASNZ4751), 462 (ASNZ1644), 463	RSP041926	RSP041928	10°	Both	9	\$1.64	RSP042104	RSP042093
408, 411, 412, 415	RSP042022	RSP042026	10°	Both	9	\$1.88	RSP042122	RSP053367
442 (HD Disc), 452 (HD Disc), 462 (HD Disc), 463 (HD Disc)	RSP042034	RSP042037	10°	Both	9	\$2.27	RSP042122	RSP053367
615, 616, 617, 720TD, 720HD, 750 HD, 820TD, 1409, 1410, 1411, 1412, 1431, 1432, 1441, 1442, 2331, 2332, 2353, 2355, 2358, H6730, H6740, H6750, H6830, H7220, H7230, H7320, H7330, H7450, H7460, H7550, H7560	RSP042056	RSP042055	7°	Top	10	\$2.43	w/o lifters RSP052673, w/ lifters RSP052939	RSP052674
	RSP041986	RSP041987	14°	Top	10	\$2.43		
313, 316, 416, 419	RSP343225	RSP343226	7°	Top	10	\$2.91	n/a	RSP052674
	RSP255700	RSP255699	14°	Top	10	\$2.91		
	RSP271205	RSP271203	18°	Top	10	\$2.91		
	RSP375859		Dome	Both	4	\$5.46		
DC101F, DC102, DC102F, DC103, DC132, DC132F, DC162, DC162F, DC92, DC92F, DC93, DCX101, DCX131, DCX131F, DCX161, DCX91, MD72, MD73, MD82, DM92, MD93, MDX71, MDX81, MDX91, RD132, RD16, RD182, RDX131, RDX161, RDX181, TD102, TD103	RSP054144	RSP054142	7°	Top	10	\$3.99	n/a	n/a
	RSP054136	RSP054133	14°	Top	10	\$3.99		
<b>New Idea</b>								
1345, 1355, 1365, 1372, 1375, 9070, 9075, 9080, 9175, 9185, 9190, 9192, 5070, 5512, 5515, 6070	RSP042022	RSP042026	10°	Both	9	\$1.88	RSP052668	RSP052669
	RSP042031	RSP042030	11°	Bottom	10	\$2.16		
	RSP042011	RSP042010	11°	Top	10	\$2.37		
	RSP042050	RSP042049	18°	Bottom	10	\$2.14		
	RSP052497	RSP052498	18°	Top	10	\$2.54		
5209 (ASN16012), 5212 (ASN16012), 5312, 5406, 5407, 5408, 5409, 5410 (SN>1007481), 5512	RSP052698	RSP052697	18°	Top	10	\$2.66	RSP042134	RSP051061
	RSP042059	RSP042057	11°	Top	10	\$2.33		
5209 (BSN16013), 5212 (BSN16012)	RSP042064	RSP042066	11°	Top	10	\$2.01	RSP052234	RSP052235
526, 527, 528, 5207, 5406 (SN 1001159-1007480), 5407 (SN 1001159-1007480), 5408 (SN 1001159-1007480), 5409 (SN 1001159-1007480), 5410 (SN<1007480), 5412	RSP042064	RSP042066	11°	Top	10	\$2.01	n/a	n/a
<b>PZ Zweegers</b>								
CM135, CM165, CM167, CM168, CM170, CM210, CM211, CM212, CM220	RSP041899		Dome	Both	4	\$1.37	n/a	n/a
CM215, 135, 164, 166, 167, 168, 170, 184, 210	RSP041892		Flat	Both	1	\$1.54	n/a	n/a
<b>Vermeer</b>								
5020, 6020, 7020, 8020, M5030, M5040, M6030, M6040, M7030, M7040, M8030, M8040, MC830, MC840, MC1030, MC2800, MC3300, MC3700, MC4500, RC5120, RC7120, RC9120, TM600, TM700, TM800, TM850, TM1200, TM1210, TM1400, TM1410	RSP596001	RSP596002	11°	Top	10	\$2.81	n/a	n/a
<b>Vicon</b>								
AM2800, CM216, CM217, CM2200, CM2800, DMP2800, GMR2800, KM281 (late model), KM216, KM391CP, KM2800, OM216, OM281	RSP042006	RSP042007	11°	Top	10	\$2.17	n/a	n/a
AM3200, CM165, CM167, CM240, CM247, CM1700, CM2400, KM165, KM240, KM241, KM281 (Early Model), KM321, KM3200, KM4000, KMR3800, KMT3001, DMP2400, DMP3200, GMR2400, GMR3200, OM165, OM241	RSP042064	RSP042066	11°	Top	10	\$2.01	n/a	n/a

Radura Disc Mower Blade Hardware		
Product ID	Description	Price
RSP042093	Nut	\$1.62
RSP042096	Bolt	\$2.07
RSP042100	Bolt	\$2.31
RSP042104	Bolt	\$2.17
RSP042109	Nut	\$1.44
RSP042122	Bolt	\$2.42
RSP042128	Bolt	\$2.96
RSP042134	Bolt	\$1.01

Radura Disc Mower Blade Hardware		
Product ID	Description	Price
RSP045702	Nut	\$0.16
RSP051061	Nut	\$3.16
RSP052234	Bolt	\$1.75
RSP052235	Nut	\$2.24
RSP052668	Bolt	\$1.01
RSP052669	Nut	\$2.63
RSP052670	Bolt	\$2.70

Radura Disc Mower Blade Hardware		
Product ID	Description	Price
RSP052671	Nut	\$0.35
RSP052673	Bolt (w/o Lifter)	\$2.48
RSP052674	Nut	\$2.63
RSP052939	Bolt (with Lifter)	\$3.35
RSP053367	Nut	\$1.96
RSP060022	Bolt	\$1.47
RSP219970	Nut	\$0.58

# BALING - POLY PICKUP BANDS

## Don't Settle for Metal!

Replace your baler's metal bands with poly pickup bands. These bands are manufactured from impact-resistant plastic and will not bend or break when you hit rocks or other objects in the field.



These pickup bands are a 1/2 inch thick and have an additional 1/4 inch thick reinforced support ring on the inside to strengthen and **maintain their shape** along with making them **impact resistant**.

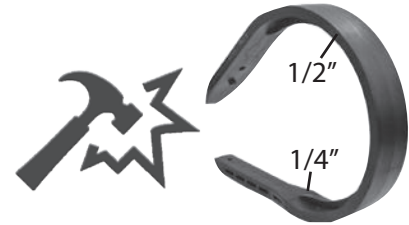
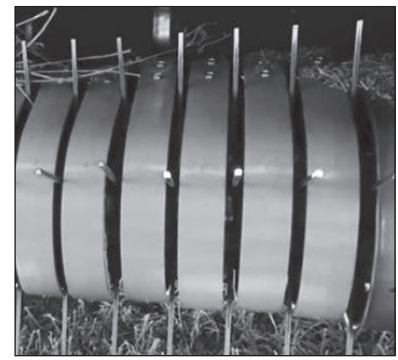

Each band comes complete with hardware. Installation is easy. You can replace just the worn out metal bands or replace all of them at once.

### May Wes Poly Pickup Bands

Case IH Square Balers					
Model	Head Size	Qty Req	OEM #	Product ID	Price/Ea
LB324, LB333, LB334, LB424, LB433, LB434, LBX322, LBX331, LBX332, LBX421, LBX422 (with standard and packer cutter head)	-	-	84468627, 84607815, 84801631, 84214800, 84274387	MYW083483	\$21.50
LB324, LB333, LB334, LB424, LB433, LB434, LBX322, LBX331, LBX332, LBX421, LBX422 (with roto cutter head)	-	-	84607781, 84274384	MYW083484	\$21.50
8550, 8570, 8575, 8585	-	-	700108607	MYW083480	\$28.95
SB521, SB531, SB541, SB551, SBX520, SBX530, SBX540, SBX550	-	-	86635483	MYW083676	\$28.95
Case IH Round Balers					
Model	Head Size	Qty Req	OEM #	Product ID	Price/Ea
RBX442, RBX443, RB444	-	11	86619049	MYW083589	\$28.95
RBX441	-	17	86619049	MYW083589	\$28.95
RBX443	-	11	86637150	MYW083590	\$28.95
RBX451, RBX452, RBX453, RBX461, RBX462, RBX463, RB454, RB464	1.5M	23	86618417	MYW083704	\$28.95
RBX453	1.8M	27	86618417	MYW083704	\$28.95
RB564	Standard	23	86643381	MYW083485	\$28.95
RBX452, RBX462, RBX463, RB454, RB464	1.8M	27	86643381	MYW083485	\$28.95
RBX452, RBX453, RBX462, RBX463, RB454, RB464	2.0M	31	86643381	MYW083485	\$28.95
RBX552, RBX562, RBX563, RB564	2.0M	Outer 10	86643381	MYW083485	\$28.95
	2.0M	Middle 21	87055363	MYW083486	\$28.95
RBX552, RBX553, RBX561, RBX562, RBX563, RB554	Standard	23	87041202	MYW083591	\$28.95
RB565	1.5M	23	84370744	MYW083650	\$28.95
RB565	2.0M	31	84310057	MYW083651	\$28.95
RB455, RB465	1.8M	27	84329282	MYW083817	\$28.95
RB455, RB465	2.0M	31	84329282	MYW083817	\$28.95
Claas Balers and Self-Propelled					
Model	Head Size	Qty Req	OEM #	Product ID	Price/Ea
Jaguar, Quadrant, Quantum, Rollant, Variant	-	-	987770, 986434	MYW083819	\$28.95
John Deere Round Balers					
Model	Head Size	Qty Req	OEM #	Product ID	Price/Ea
330, 335, 375, 385, 430, 435, 447, 448, 449, 456, 458, 459, 466, 467, 468, 469, 535, 545, 546, 547, 550, 556, 558, 559, 566, 567, 568, 569, 570, 572, 580, 582, 590, 592	-	-	CC32669, E85043, FH311772	MYW083478	\$28.95

# BALING - POLY PICKUP BANDS

<b>John Deere Round Balers (Continued)</b>					
447, 448, 449, 456, 458, 459, 466, 467, 468, 469, 535, 545, 546, 547, 550, 556, 558, 559, 566, 567, 568, 569	-	-	FH311995	MYW083845	\$28.95
Mega Wide Head - Outer 3	-	-	FH311994, E96760	MYW083701	\$28.95
<b>John Deere Self-Propelled Harvester</b>					
Model	Head Size	Qty Req	OEM #	Product ID	Price/Ea
630A, 640A, 645A, 630B, 640B, 645B, 630C, 640C, 645C	-	-	CC32669, E85043, FH311772	MYW083479	\$28.95
<b>New Holland Square Balers</b>					
Model	Head Size	Qty Req	OEM #	Product ID	Price/Ea
27P, 29P, 707W, 717W, 770W, 790W, 880W, 890W, 900W, 919W3, 919W4, 990W	-	-	86625275	MYW083489	\$28.95
590, 595, BB940, BB960, BB9050, BB9060, BB9070, BB9080, 230, 330, 340 (with roto cutter head)	-	-	84074345, 84214794, 84274385	MYW083482	\$21.50
276, 311, 315, 316, 320, 326, 565, 568, 570, 575, 580, BC5050, BC5060, BC5070, BC5080 (with roto cutter head)	-	-	86635482, 184550	MYW083677	\$28.95
585 (with roto cutter head)	-	-	-	MYW083489	\$28.95
590, 595, BB940, BB960, BB9050, BB9060, BB9070, BB9080, 230, 330, 340 (with standard and packer cutter head)	-	-	84801630, 89837845, 85005357, 84214799, 84274388	MYW083481	\$21.50
<b>New Holland Round Balers</b>					
Model	Head Size	Qty Req	OEM #	Product ID	Price/Ea
634,638	Standard	11	86619048	MYW083586	\$28.95
630, BR7050, BR7060, BR730, BR730A	Standard	17	86619048	MYW083586	\$28.95
640, 650, 660	Standard	23	86619048	MYW083586	\$28.95
640, 644, 648, 650, 654, 658, BR7060, BR7070, BR740, BR740A, BR750, BR750A, RB450, RB460	Wide/1.5M	23	86618414	MYW083703	\$28.95
644, 648, 654, 658, BR730A, BR740, BR740A	Standard	17	86637149, 86512793	MYW083587	\$28.95
664, 678, 688	Standard	23	86637149	MYW083587	\$28.95
BR7080, BR7090, BR770, BR770A, BR780, BR780A	Standard	23	87041203	MYW083588	\$28.95
BR7060, BR7070	1.8M	Outer 10	86643380	MYW083487	\$28.95
	1.8M	Middle 21	87055364	MYW083488	\$28.95
BR740, BR740A, BR750, BR750A	1.8M x.s.	Outer 10	86643380	MYW083487	\$28.95
	1.8M x.s.	Middle 17	87055364	MYW083488	\$28.95
BR7060, BR7070, BR740, BR740A, BR750, BR750A, BR780	2.0M	31	86643380	MYW083487	\$28.95
BR7090, BR780A	2.0M x.s.	Outer 10	86643380	MYW083487	\$28.95
	2.0M x.s.	Middle 21	87055364	MYW083488	\$28.95
RB450, RB460	1.8M	27	84329281	MYW083839	\$28.95
RB450, RB460	2.0M	31	84329281	MYW083839	\$28.95
RB550, RB560	1.5M	23	84370743	MYW083648	\$28.95
RB550, RB560	2.0M	31	84310058	MYW083649	\$28.95
<b>New Holland Self-Propelled Chopper</b>					
Model	Head Size	Qty Req	OEM #	Product ID	Price/Ea
280FP, 290FP, 380FPA, 380FPE, 346W, 356W, 366W	-	-	87696240, 86631272, 87584380	MYW083592	\$28.95
<b>Vermeer Round Balers</b>					
Model	Head Size	Qty Req	OEM #	Product ID	Price/Ea
I, Super I, J, Super J, K, L, XL, Super M, N, Rancher, Rebel	-	-	89982001	MYW083706	\$28.95
Pro Baler	-	-	510547156	MYW083818	\$28.95

# RASSPE™ BALER KNOTTERS for Square Balers



**The Specialist for  
Knotter Technology**



The process of knotting and tying have a major impact on the overall performance and efficiency of a square baler. Bale twine has to withstand enormous strain as the baled material rebounds after binding. **Therefore, knot strength is the be-all and end-all in the tying process.** Rasspe™ has a long-standing tradition of superior reliability and durability in twine knotters for square balers.

## RS 1450 High Density Double Knotter

This HD double knotter's minimal twine spacing of 6.8 inches / 172 mm makes it possible to use 4-6 knotters on 31.5-47.2 inches / 800-1200 mm chamber machines.

- Split hub for easy service and maintenance
- Great resistance to wear
- For hay, straw, corn stalks and silage bales
- Ties up to 120 lbf twines
- For high-density bales
- Designed for square balers

### RS 1450 Heavy Density Double Knotter

Make/Models	Without Cam Gear			With Cam Gear		
	OEM #	Product ID	Price	OEM #	Product ID	Price
Case-IH- 8570, 8575, 8576, 8580, 8585, 8590	700113321 700204084	RSB700321	\$1,118.63	-	RSB700084	\$1,371.88
Challenger- 2240, 2250, 2260, 2270, 2270XD, 2290						
Fendt- 12130, 1270N, 1270S, 1290N, 1290S						
Hesston- 4750, 4755, 4760, 4790, 4900, 4910						
Massey Ferguson- 2150, 2160, 2170, 2170XD, 2240, 2250, 2260, 2270, 2270XD, 2290						
New Holland- BB980						

## RS 6003 Single Knotter

The RS 6003 is a more rugged version of the single knotter and offers outstanding durability for use on high-performance balers. It is typically used on balers that produce small packs at high annual output rates.

- Great resistance to wear
- Split hub
- For hay, straw and silage bales
- 2-3 knotter modules
- Easy maintenance

### RS 6003 Single Knotter

Make/Models	Without Cam Gear			With Cam Gear		
	OEM #	Product ID	Price	OEM #	Product ID	Price
AGCO- 1841, 7120	700709740	RSB042951	\$1,063.86	700709845	RSB042997	\$1,245.76
Case-IH 8555						
Challenger- 1842, SB44						
Hesston- 4655, 4690, 4690S						
Massey Ferguson- 1841, 1842, 1843N, 1843S, 1844N, 1844S						



#RSB700321 - RS 1450 High Density Double Knotter



#RSB700084 - RS 1450 High Density Double Knotter with Cam Gear



#RSB042997- RS 6003 Single Knotter with Cam Gear

# BUSHEL PLUS MINI COMBINE

**Identical Crop Samples to a Combine, Only Portable!**



## Accurate Crop Samples in Less than 5 Minutes!

Bushel Plus' Mini Combine is a portable tool, comprised of a picker/threshing drum and an aerator/blower, for taking samples of wheat, barley, canola, sorghum, oats, soya, peas, field beans, and flax.

**Samples collected are identical to a combine giving you the perfect sample size for moisture content tests and quality analysis.**

This self-contained, electric unit comes with four interchangeable concaves (no tools required), a lithium-ion battery and a variable-speed brushless motor.



### Save Time and Fuel

Every farmer wants to get harvesting as soon as the crop is ready, but it can be time-consuming to test your crop to make sure conditions are right.

The Mini Combine gives you accurate grain samples in minutes, without the time and expense of taking your combine to the field.



Mini Combine		
Product ID	Description	Price
BPS144000	Mini Combine, Portable Crop Sampling Tool	\$1,565.00

## HCC GATEWAY CHAFFERS & SIEVES - SERVICE PARTS

All components of the HCC Gateway Chaffers and Sieves are replaceable for quick and economic repair.

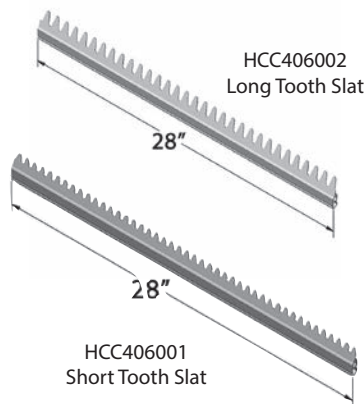
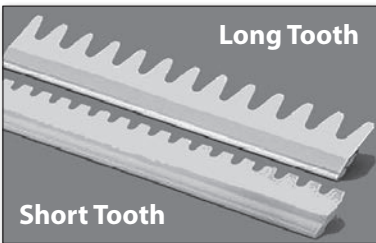

Gateway Service Parts		
Product ID	Description	Price
HCC406001	Slat, Short Tooth, 28"	\$10.25
HCC406002	Slat, Long Tooth, 28"	\$10.25
HCC909050	Slat, Flat, Long, 28"	\$10.25
HCC909051	Slat, Flat, Short, 28"	\$10.25
HCC409000	Connector, Female	\$3.00
HCC409001	Connector, Male	\$3.00
HCC409002	Center Connector, Long	\$1.90
HCC409003	Center Connector, Short	\$1.90
HCC409004	End Connector, RH	\$3.00
HCC409005	End Connector, LH	\$3.00
HCC212366	Push Nut, .25 diameter	\$0.65
HCC002641	Gateway Riser Kit, Hillside Divider	\$47.61



HCC409000  
Female  
Connector



HCC409001  
Male  
Connector



HCC409002  
Long Center  
Connector



HCC409003  
Short Center  
Connector



HCC409004  
End  
Connector, RH



HCC409005  
End  
Connector, LH



HCC212366  
Push Nut

Visit our website for easy ordering [www.sidist.com](http://www.sidist.com)

# AUGER EXTENSIONS KITS FOR COMBINES



**Gleaner Unloading Auger Extension Kit - #HRV130101**



**John Deere Unloading Auger Extension Kit - #HRV130106**



**John Deere Unloading Auger Extension Kit - #HRV130109**

*All unloading auger extensions kits come with complete hardware and instructions.*

## Unloading Auger Extension Kits

Case-IH	Product ID	Price
1400, 1600 series, 36" Auger Extension (round drive)	HRV130104	\$1,193.80
1600, 2100, 2300 series, 36" Auger Extension (spline drive)	HRV130105	\$1,256.58
Gleaner	Product ID	Price
L, M, N & Early R Series, 30" Auger Extension, 12" Diameter	HRV130101	\$1,130.80
Late R Series, 30" Auger Extension, 12" Diameter	HRV130102	\$1,332.06
Late R & S Series, 36" Auger Extension, 14" Diameter	HRV130103	\$1,225.76
John Deere	Product ID	Price
6620 - 9750, 36" Unloading Auger Extension	HRV130106	\$1,089.45
6620 - 9750, 24" - 30" Unloading Auger Extension	HRV130107	\$1,199.50
9560, 9660, 9760, 9750 Unloading Auger with end discharge - Standard Rate, 36" Auger Extension	HRV130108	\$1,247.51
9660STS, 9760STS, 9860STS, 9670STS, 9770STS, 9870STS - High Rate, 36" Auger Extension	HRV130109	\$1,508.28
9660STS, 9760STS, 9860STS, S660, S670, S680, S690 - High Rate, 36" Auger Extension for folding system	HRV130110	\$3,574.00

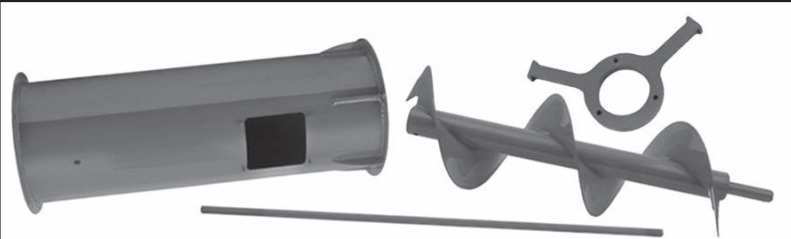

**Case-IH Unloading Auger Extension Kit - #HRV130105**

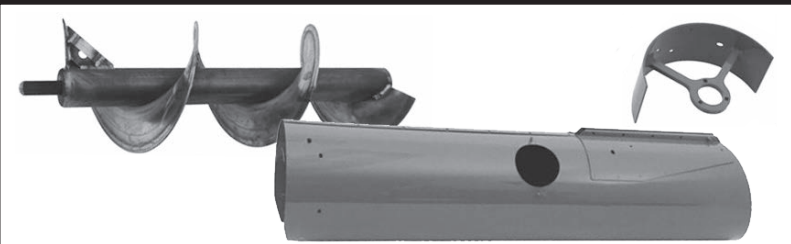

**John Deere Unloading Auger Extension Kit - #HRV130108**

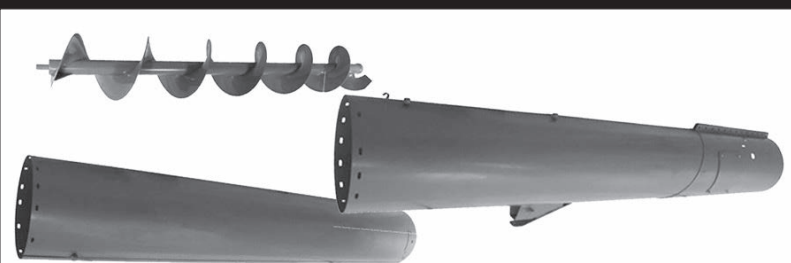

**John Deere Unloading Auger Extension Kit - #HRV130110**

# UNLOADING AUGER TUBES

Unloading Auger Tubes						
Case-IH	Description	Overall Length	Piece Length	OEM Number	Product ID	Price
1620, 1640, 1644, 1660, 1666, 1670, 1680, 1688, 2144, 2166, 2188, 2344, 2365, 2366, 2377, 2388 BSN HAJ300001	Inner Solid Unloading Tube	136", 172", 208"	90"	1317738C1	HRV180030	\$791.13
	Inner Perforated Unloading Tube	136", 172", 208"	90"	1317783C2	HRV131787	\$841.56
	Outer Unloading Tube	136"	46-1/2"	1317734C2	HRV131773	\$588.16
	Outer Unloading Tube	172"	82-1/2"	1317783C4	HRV180031	\$725.00
	Outer Unloading Tube	208"	118-1/2"	1317899C3	HRV180032	\$755.00
2388 ASN HAJ300001, 2577 ASN HAJ300001, 2588 ASN HAJ300001	Inner Solid Unloading Tube	18', 21'	126"	87557135	HRV875135	\$1,116.50
	Outer Unloading Tube	18'	82-1/2"	87581650	HRV875650	\$1,082.73
	Outer Unloading Tube	21'	118"	87581654	HRV875654	\$1,130.15
5088, 6088, 7088, 5130, 5140, 5150, 6130, 6140, 6150, 7130, 7140, 7150, 7230, 7240, 7250, 8230, 8240, 8250, 9230, 9240, 9250	Outer Unloading Tube, Standard Rate		198-1/4"	87743673	HRV877673	\$1,998.22
7230, 7240, 8230, 8240, 9230, 9240	Outer Unloading Tube, High Rate	21'	194-5/8"	47405760	HRV474760	\$2,065.54
7230, 7240, 7250, 8230, 8240, 8250, 9230, 9240, 9250	Outer Unloading Tube, High Rate, Folding		87-1/2"	47407783	HRV474783	\$1,541.29
7240 ASN YEG227001, 7250, 8240 ASN YEG227001, 8250, 9240 ASN YEG227001, 9250	Inner Unloading Tube, High Rate, Folding		172"	47551157	HRV475157	\$3,122.47
Challenger	Description	Overall Length	Piece Length	OEM Number	Product ID	Price
660, 670	Unloading Tube		213-1/2"	71399669	HRV713669	\$2,182.89
Gleaner	Description	Overall Length	Piece Length	OEM Number	Product ID	Price
L, M, N, R	Unloading Tube, Silver		145-5/8"	71383428	HRV180020	\$762.83
	Unloading Tube, Galvanized		145-5/8"	71368075	HRV180021	\$750.43
A65, A75	Unloading Tube, Silver		213-1/2"	71399669	HRV180024	\$2,295.00
R62, R72, R65, R75	Unloading Tube, Chassis Gray		180-3/4"	71390923	HRV180022	\$2,266.86
S67, S77	Unloading Tube		216-3/4"	71444325	HRV180023	\$2,329.06
John Deere	Description	Overall Length	Piece Length	OEM Number	Product ID	Price
6620, 7720, 8820 BSN 600001 -14' 8820 ASN 600001, 9400, 9410, 9450, 9500, 9510, 9550, 9600, 9610, 9650, 9650CTS, 9650STS, 9750STS -17'	Unloading Tube	14', 17'	144-1/2"	AH145049	HRV180010	\$950.25
7720, 8820 BSN 600001 -17' 8820 ASN 600001, 9400, 9410, 9500, 9510, 9550, 9600, 9610, 9650, 9650CTS, 9650STS, 9750STS -20'	Unloading Tube	17', 20'	180-1/2"	AH145050	HRV180011	\$1,155.50
9560, 9560STS	Outer Unloading Tube	18-1/2'	144"	AH210024	HRV180012	\$1,147.36
9560, 9560STS, 9570STS, 9660, 9660CTS, 9660STS, 9670STS, 9760STS, S550, S660	Outer Unloading Tube	21-1/2'	180-1/4"	AH210023	HRV180013	\$1,226.53
9660STS, 9760STS, 9860STS, 9670STS, 9770STS, 9870STS, S660 BSN 775000, S670 BSN 775000, S680 BSN 775000, S690 BSN 775000	Outer Unloading Tube, High Rate	22-1/2'	184"	AH203020	HRV803020	\$2,010.41
S660 ASN775000, S670 ASN775000, S680 ASN775000, S690 ASN775000, S760, S770, S780, S790	Outer Unloading Tube, High Rate	22-1/2'	161-5/8"	AXE68706	HRV868706	\$3,640.70
S660ASN765172, S670ASN765172, S680ASN765172, S690ASN765172, S760, S770, S780, S790	Middle Unloading Tube, High Rate	26', 28-1/2'	93-3/8"	AXE68701	HRV868701	\$2,906.50
9670STS, 9770STS, 9870STS, S660, S670, S680, S690, S760, S770, S780, S790	Outer Unloading Tube, High Rate	26'	112-1/4"	AXE68700	HRV868700	\$1,724.81
S660ASN765172, S670ASN765172, S680ASN765172, S690ASN765172, S760, S770, S780, S790	Outer Unloading Tube, High Rate	28-1/2'	130-7/8"	AXE68702	HRV868702	\$2,903.81
9670STS, 9770STS, 9870STS, S660 BSN 775000, S670 BSN 775000, S680 BSN 775000, S690 BSN 775000	Middle Unloading Tube, High Rate, Folding	22-1/2'	115-13/16"	AH209128	HRV809128	\$1,951.01
9670STS, 9770STS, 9870STS, S660 BSN 765171, S670 BSN 7765252, S680 BSN 766006, S690 BSN 765249	Outer Unloading Tube, High Rate, Folding	22-1/2'	66"	AXE28972	HRV847449	\$1,225.00
Massey Ferguson	Description	Overall Length	Piece Length	OEM Number	Product ID	Price
8570, 8780, 9690, 9790	Early Unloading Tube		178-1/2"	71396414	HRV180041	\$1,854.36
8560, 8780	Unloading Tube		142-1/2"		HRV180040	\$1,283.66
9690, 9790	Unloading Tube		213-1/2"	71399669	HRV180042	\$2,295.00

# BUSHEL PLUS MAD CONCAVES

**MAD Concaves: Always extended wear for precision threshing and increased capacity**

No more messing with wires or cover/filler plates. Make it easy to get better harvest results and maximize your profits.

**Designed to be aggressive with quality, reliability and durability top of mind!**

Swapping out traditional combine concaves for these innovative bar-and-grate style modular Bushel Plus MAD Concaves™ results in more efficient threshing, getting your grain out of the head and into the hopper quicker for decreased rotor loss and less dockage. This means higher quality crops and more money in your pocket. **Maximize Performance:** Maximize your combine's performance efficiency with Bushel Plus MAD Concaves™. They are easy-to-change, allowing you to quickly swap out inserts in minutes and save valuable time - critical in a busy harvest season.

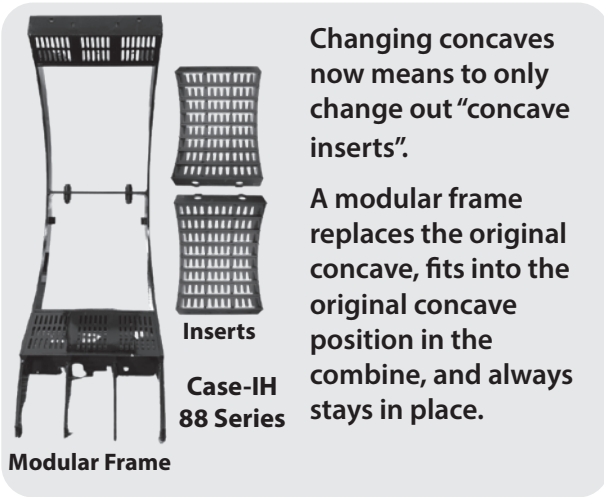

**HARVEST GAIN.  
MADE SIMPLE.**



Case-IH Flagship

New Holland 22" Twin Rotor

John Deere STS / S-Series

Case IH				
	Crops	Description	Product ID	Price
7010, 8010	Corn, Soybeans, Milo	Inserts: 2- LH O-Grates, 2- RH O-Grates	MDC202103	\$4,340.00
7120, 8120, 9120	Wheat, Flax	Inserts: 1- LH .225, 1- RH .225, 1- LH .300, 1- RH .300, 1- LH .375, 1- RH .375	MDC202105	\$5,400.00
7230, 8230, 9230	Canola, Oats, Barley, Peas	Inserts: 1- LH Finger Grate, 1- RH Finger Grate, 1- LH .375, 1- RH .375	MDC202104	\$3,600.00
7240, 8240, 9240	Wheat, Flax, Canola, Oats, Barley, Peas	Inserts: 1- LH Finger Grate, 1- RH Finger Grate, 1- LH .225, 1- RH .225, 1- LH .300, 1- RH .300, 1- LH .375, 1- RH .375	MDC202106	\$7,200.00
7260, 8260, 9260	Corn, Soybeans, Wheat, Milo	Inserts: 2- LH O-Grates, 2- RH O-Grates, 1- LH .225, 1- RH .225, 1- LH .300, 1- RH .300, 1- LH .375, 1- RH .375	MDC202107	\$9,740.00
(concaves only, no frame needed)	All Crops - Corn, Soybeans, Wheat, Milo, Flax, Canola, Oats, Barley, Peas	Inserts: 2- LH O-Grate, 2- RH O-Grate, 1- LH Finger Grate, 1- RH Finger Grate, 1- LH .225, 1- RH .225, 1- LH .300, 1- RH .300, 1- LH .375, 1- RH .375	MDC202108	\$11,540.00
Concave Kits				
	Crops	Description	Product ID	Price
1660, 1666, 1688	Corn, Soybeans, Milo	2-Split Frames, 1-Transition Lip, Inserts: 2- LH O-Grates, 2- RH O-Grates	MDC201104	\$5,465.00
2166, 2177, 2188	Canola, Barley, Oats, Peas	2-Split Frames, 1-Transition Lip, Inserts: 2- .375, 1- LH Finger Grate, 1- RH Finger Grate	MDC201102	\$4,625.00
2366, 2377, 2388, 2588	Wheat, Flax, Duram	2-Split Frames, 1-Transition Lip, Inserts: 2- .225, 2- .375	MDC201103	\$4,625.00
2577, 5088, 6088, 7088	Corn, Soybeans, Wheat, Milo, Flax, Duram	2-Split Frames, 1-Transition Lip, Inserts: 2- .225, 2- .375, 2- LH O-Grates, 2- RH O-Grates	MDC201105	\$8,205.00
5130, 6130, 7130	All Crops - Corn, Soybeans, Wheat, Milo, Flax, Duram, Canola, Barley, Oats, Peas	2- Split Frames, 1- Transition Lip, Inserts: 2- .225, 2- .375, 1- LH Finger Grate, 1- RH Finger Grate, 2- LH O-Grates, 2- RH O-Grates	MDC201106	\$9,575.00
5140, 6140, 7140				
5150, 6160, 7160				

Specialty crop inserts available upon request - call for pricing.

# BUSHEL PLUS MAD CONCAVES *Continued*

<b>Fendt</b>				
	<b>Concave Kits</b>		<b>Product ID</b>	<b>Price</b>
Ideal 7/T	Corn, Soybeans, Milo	Inserts: 4- O-Grates	MDC408101	\$4,320.00
	Wheat, Flax, Duram	Inserts: 2- .225, 2- .375	MDC408102	\$3,700.00
	Canola, Barley, Oats	Inserts: 2- Finger Grate, 2- .375	MDC408103	\$3,700.00
	Corn, Soybeans, Wheat, Milo, Flax, Duram	Inserts: 4- O-Grates, 2- .225, 2- .375	MDC408104	\$8,020.00
	All Crops - Corn, Soybeans, Wheat, Flax, Duram, Canola, Barley, Oats	Inserts: 4- O-Grates, 2- Finger Grates, 2- .225, 2- .375	MDC408105	\$9,870.00
<b>Fendt</b>				
	<b>Concave Kits</b>		<b>Product ID</b>	<b>Price</b>
Ideal 8/T, Ideal 9/T, Ideal 10/T	Corn, Soybeans, Milo	Inserts: 8- O-Grates	MDC400101	\$8,640.00
	Wheat, Flax, Duram	Inserts: 4- .225, 4- .375	MDC400102	\$7,400.00
	Canola, Barley, Oats	Inserts: 4- Finger Grate, 4- .375	MDC400103	\$7,400.00
	Corn, Soybeans, Wheat, Milo, Flax, Duram	Inserts: 8- O-Grates, 4- .225, 4- .375	MDC400104	\$16,040.00
	All Crops - Corn, Soybeans, Wheat, Flax, Duram, Canola, Barley, Oats	Inserts: 8- O-Grates, 4- Finger Grates, 4- .225, 4- .375	MDC400105	\$19,740.00
<b>John Deere</b>				
	<b>Concave Kits</b>		<b>Product ID</b>	<b>Price</b>
9650 STS, 9750 STS 9660 STS, 9760 STS, 9860 STS 9670 STS, 9770 STS, 9870 STS S650, S660, S670, S680, S690 S760, S770, S780, S790 S7 600, S7 700, S7 800, S7 900	Corn, Soybeans, Milo	2-Split Frames, 1-Transition Lip, Inserts: 2- LH O-Grates, 2- RH O-Grates, One Piece: 1- O-Grate	MDC101107	\$6,950.00
	Wheat, Flax, Duram	2-Split Frames, 1-Transition Lip, Inserts: 2- .225, 2- .375, One Piece: 1- O-Grate	MDC101110	\$6,110.00
	Canola, Barley, Oats	2- Split Frames, 1- Transition Lip, Inserts: 2- .375, 1- LH Finger Grate, 1- RH Finger Grate, One Piece: 1- O-Grate	MDC101111	\$6,110.00
	Corn, Soybeans, Wheat, Milo, Flax, Duram	2- Split Frames, 1- Transition Lip, Inserts: 2- .225, 2- .375, 2- LH O-Grates, 2- RH O-Grates, One Piece: 1- O-Grate	MDC101108	\$9,690.00
	All Crops - Corn, Soybeans, Wheat, Flax, Duram, Canola, Barley, Oats	2- Split Frames, 1- Transition Lip, Inserts: 2- .225, 2- .375, 1-LH Finger Grate, 1- RH Finger Grate, 2- LH O-Grates, 2- RH O-Grates, One Piece: 1- O-Grate	MDC101109	\$11,060.00
	<b>John Deere</b>			
	<b>Concave Kits</b>		<b>Product ID</b>	<b>Price</b>
X9 1000, X9 1100  (concaves only, no frame needed)	Corn, Soybeans, Pulses, Edible Beans, Milo	Inserts: 12-O-Grates	MDC109104	\$12,960.00
	Wheat, Flax	Inserts: 6- .225, 6- .435	MDC109101	\$11,100.00
	Canola, Barley, Oats	Inserts: 4- .225, 8- .435	MDC109102	\$11,100.00
	Wheat, Flax, Canola, Barley, Oats	Inserts: 6- .225, 8- .435	MDC109103	\$12,950.00
	All Crops - Corn, Soybeans, Wheat, Flax, Canola, Barley, Oats, Pulses, Edible, Beans, Milo	Inserts: 6- .225, 8- .435, 12- O-Grates	MDC109105	\$25,910.00
<b>New Holland</b>				
	<b>Concave Kits</b>		<b>Product ID</b>	<b>Price</b>
CR 970, CR 980 CR 9070, CR 9080, CR 9090, CR 8090 CR 8.80, CR 8.90, CR 9.80, CR 9.90, CR 10.90	Corn, Soybeans, Milo	2-Frames, Inserts: 4- O-Grate, Extensions: 2- .500	MDC301104	\$6,990.00
	Wheat, Flax	2-Frames, Inserts: 2- .225, 2- .375, Extensions: 2- .300	MDC301106	\$6,390.00
	Canola, Barley, Oats	2-Frames, Inserts: 2- .375, 2-Finger Grates, Extensions: 2- .300	MDC301105	\$6,390.00
	Corn, Soybeans, Wheat, Milo, Flax	2-Frames, Inserts: 2- .225, 2- .375, 4- O-Grates, Extensions: 2- .300, 2- .500	MDC301107	\$11,290.00
	All Crops - Corn, Soybeans, Wheat, Flax, Canola, Barley, Oats	2-Frames, Inserts: 2- .225, 2- .375, 2-Finger Grates, 4- O-Grates, Extensions: 2- .300, 2- .500	MDC301108	\$12,690.00

Specialty crop inserts available upon request - call for pricing.

# REPLACEMENT REEL TINES

## HCC Standard Reel Tinies

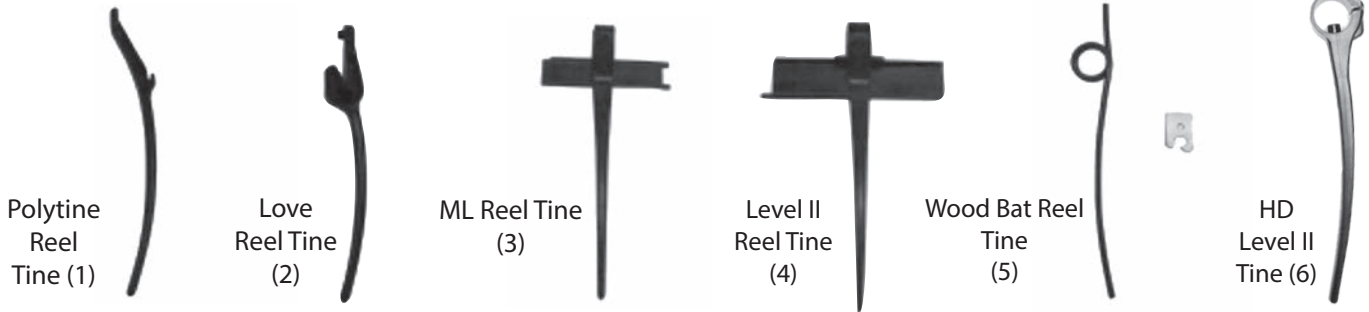

- (1) **Polytine Reels** have a teardrop shaped metal bat with notches spaced 4.5" (114 mm) apart. The tines fit into the notches and are fastened to the back of the metal bat approximately 3" (76 mm) above the notch. Supplied from 1984-1989.
- (2) **Love Reels** have a sheet metal bat and the tine fastens over the bottom edge. There is a projection that fits into a hole on the front of the bat approximately 2.5" (64 mm) above the edge. The Love Reel was not manufactured by HCC Inc.
- (3) **ML Reels** have a 1.375" (35 mm) tube with 0.4" (10 mm) round holes spaced approximately 4.5" (114 mm) apart. The tines have a round nub that fits into a round hole in the tube. Supplied from 1989-1999.
- (4) **Level II Reels** have a 1.375" (35 mm) tube with 0.5" (12.7 mm) hex holes spaced 6.0" (152 mm) apart. The tines have a hex nub that fits into a hex hole in the tube. Standard since 1999/2000. **(6) is a heavy-duty alternative.**
- (5) **Wood Bat Reels** have a wood bat with steel tines spaced approximately 4.5" (114 mm) apart. The tines are pressed into the bat and there is a metal clip riveted to the bat to provide support to the tine.
- (6) **Level II Reels, Heavy-Duty** are a heavy-duty alternative to (4) Level II Reels. The overall length of the heavy duty tine is 11-7/8" (302 mm) and the strap width is 1-1/8" (29 mm).

Replacement Reel Tinies					
Product ID	Description	Price/Each	Product ID	Description	Price/Each
HCC224014	Polytine reel tine (1)	\$1.49	HCC224047	Level II reel tine, full wing (4)	\$2.65
HCC224015	Love reel tine (2)	\$2.29	HCC224048	Level II reel tine, left hand wing (4)	\$2.85
HCC224016	ML reel tine, double wing (3)	\$2.15	HCC224049	Level II reel tine, right hand wing (4)	\$2.85
HCC224017	ML reel tine, right hand wing (3)	\$2.59	HCC224050	Level II reel tine, no wing (4)	\$2.85
HCC224018	ML reel tine, left hand wing (3)	\$2.59	HCC224081	Level II heavy duty reel tine, no wing (6)	\$3.83
HCC224019	ML reel tine, no wing (3)	\$2.59	HCC480056	Wood bat steel tine (5)	\$4.35
-	-	-	HCC480057	Clip, for wood bat steel tine (5)	\$0.34

Installation hardware included.

## THE PADDLE Replacement Reel Tinies



- When crop conditions make harvesting difficult and inefficient, the Paddle is the cost-effective alternative to standard tines.
- The Paddle provides full crop contact, even with short crop, and delivers positive and even feeding into the header.
- Helps reduce or eliminate the need for an expensive air reel.
- The patented tine mounting system makes installation fast and easy.

# PADDLE

*The Paddle's six-inch width lifts and feeds crop that standard tines miss.*



Original Tine Spacing	Paddle Tinies Per Reel Width				
	18'	20'	25'	30'	36'
4.5"	40	40	50	60	N/A
6.0"	30	40	40	50	60

Paddle Tinies		
Product ID	Description	Price/Each
HCC983950	Paddle Tine, Polytine reel (1)	\$12.25
HCC983845	Paddle Tine, ML reel (3)	\$9.75
HCC983846	Paddle Tine, Level II reel (4)	\$9.75
HCC983949	Paddle Tine, wood bat reel (5)	\$12.25

# REPLACEMENT REEL TINES

## 5-Finger Quick Tines



- Designed for use in soybeans, wheat, canola, chickpeas, lupins, and flax.
- Easily slips over the existing finger, attaching directly to the bar. No tools needed.



**#HRV983834 is designed to fit over:** Case-IH 2162, 2152, 2142; MacDon FD70, FD75, FD1; New Holland 86C, 83C, 82C

**#HRV983836 is designed to fit over:** John Deere 630FD, 635FD, 640FD, 645FD serial# 785,000 and above, 730FD, 735FD, 740FD, 745FD

**#HRV983849 is designed to fit over:** Case-IH 3162, 3152; New Holland 840CD, 880CF

**#HRV983838 is designed to fit over:** AGCO 300-800, 8000, 8200, 9250; Case-IH 1010, 1020, 2010, 2020, 3020; John Deere 900, 600, 600FD (before serial number 785000); Massey Ferguson 8000, 8200, 9250, 9700, 9750, 9800, 9850; New Holland 971, 973, 71C, 72C, 73C, 74C, 92C, 94C, 740CF

5 Finger Quick Tine		
Product ID	Description	Price/Ea
HRV983834	5 Finger Quick Tine, Case IH, MacDon, ND; FD - 5-1/2" wide	\$7.64
HRV983836	5 Finger Quick Tine, JD 600FD, 700FD - 5-1/2" wide	\$7.64
HRV983849	5 Finger Quick Tine, Case-IH, NH; 5-1/2" wide	\$7.64
HRV983838	5 Finger Quick Tine, AGCO, CIH, JD, M/F, NH - 4" wide	\$6.42

Make	Quick Tines Per Reel Width			
	30'	35'	40'	45'
John Deere	120	140	160	180
MacDon	105	125	140	155

## SNAP-ON & QUICK FINGER Replacement Tines



- **QUICK** Repair
- **EASY** Installation; **No Tools Required**



Snap On Replacement Tines		
Product ID	Description	Price/Ea
HRV983835	Replacement Snap On Tine, CIH, MacDon, NH; FD	\$5.49
HRV983837	Replacement Snap On Tine, JD 600FD, 700FD	\$5.49

**#HRV983835 is designed to fit over:** Case-IH 2162, 2152, 2142; MacDon FD70, FD75, FD1; New Holland 86C, 83C, 82C

**#HRV983837 is designed to fit over:** John Deere 630FD, 635FD, 640FD, 645FD serial# 785,000 and above, 730FD, 735FD, 740FD, 745FD

**The Quick Finger will fit the following pipe reels:**

AGCO: 300, 400, 500, 700, 800 series heads  
 CASE-IH: 1010, 1020, 2020, series heads  
 Caterpillar 1998 and later  
 John Deere 900, 600, early 600FD series heads  
 Massey Ferguson 9700, 9750, 9800, 9850 series heads  
 New Holland 971, 973, 71C, 73C, 72C, 74C series heads

**Note:** Will only properly fit Level II pipe reels with 6" tine spacing. Quick Finger will fit ML reels with 4.5" tine spacing but it will be 3/8" shorter than the original tine.

Quick Finger Replacement Tines		
Product ID	Description	Price/Ea
PDM010000	Quick Finger	\$2.35



# HCC ORBIT TRAC II REEL KIT



HCC has closed that gap with the Orbit™ Trac II Reel.

- Eliminates the Reel - Auger Gap
- Positively places crop into auger
- Reduces or eliminates slugging
- Resists wrapping in green crop
- On-farm installation in a few hours

Its revolutionary reel design brings the tines right up to the auger to positively place crop into the auger, providing true continuous crop flow.

**It allows you to harvest more crop in less time.**

**Unique design allows tines to swing directly past auger.**

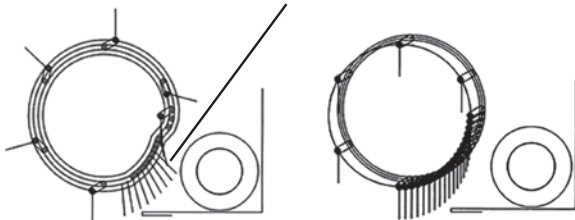

Orbit Reel™

Standard Reel

## Orbit Trac II Service Parts

Product ID	Product Description	Price
HCC031410	Orbit Trac II Update Kit, 22' and longer (Steel track for bottom half of Orbit Reel)	\$965.15
HCC031411	Orbit Trac II Update Kit, 20' and shorter, LH (Steel track for bottom half of Orbit Reel)	\$482.58
HCC031412	Orbit Trac II Update Kit, 20' and shorter, RH (Steel track for bottom half of Orbit Reel)	\$482.58
HCC031413	Orbit Trac II Update Kit, 22' and longer (Steel track for top half of Orbit Reel)	\$1,290.15
HCC031414	Orbit Trac II Update Kit, 20' and shorter, (Steel track for top half of Orbit Reel)	\$645.08
HCC483993	Steel Track, Inside	\$153.82
HCC483994	Steel Track, Outside	\$168.72
HCC243719	Roller, Orbit Reel	\$28.27
HCC212412	Nut, for Orbit Reel Roller	\$0.68
HCC243736	Bearing, Reel Arm, ML & Level II reels, req 2	\$1.84
HCC481776	Strap, Reel Arm Bearing, ML & Level II	\$2.11

**Note:** The Orbit Trac II Reel kit has all of the track made out of steel. The Orbit Trac II Reel kit is designed only for HCC Inc. Level II and ML tube-type reels. They have been original equipment on most headers since 1990.

## HCC Orbit Trac II Reel Kit

Product ID	Product Description	Price
<b>AGCO 400-8000 Series</b>		
HCC131371	AGCO, 400, 500, 800, 8000 series, 25-35'	\$4,030.05
HCC131372	AGCO, 400, 500, 800, 8000 series, 22' & shorter	\$2,101.90
<b>AGCO 8200</b>		
HCC131373	AGCO, 8200 series, 25-35'	\$3,954.25
HCC131396	AGCO, 8200 series, 20' & shorter	\$2,060.10
<b>Case-IH 1010 &amp; 1020 (Verify single eccentric or double eccentric reel.)</b>		
HCC131382	Case-IH, 1994 & prior, 22' & longer 1010 headers (-JJC0200000) & 1020 headers (-JJC0215000)	\$3,954.35
HCC131383	Case-IH, 1994 & prior, 20' & shorter 1010 headers (-JJC0200000) & 1020 headers (-JJC0215000)	\$2,104.45
HCC131380	Case-IH, 1995-1997, 22' & longer 1010 headers (JJC0200001-JJC0300000) & 1020 headers (JJC0215001-JJC0315000)	\$4,257.45
HCC131381	Case-IH, 1995-1997, 20' & shorter 1010 headers (JJC0200001-JJC0300000) & 1020 headers (JJC0215001-JJC0315000)	\$2,188.95
HCC131369	Case-IH, 1998 & newer, 22' & longer 1010 headers (JJC0300001- & CBJ023001-) & 1020 headers (JJC0315001- & CBJ023003-)	\$4,090.90
HCC131370	Case-IH, 1998 & newer, 20' & shorter 1010 headers (JJC0300001- & CBJ023001-) & 1020 headers (JJC0315001- & CBJ023003-)	\$2,102.45
<b>Case-IH 2010 &amp; 2020</b>		
HCC131376	Case-IH, 2010, 2020, 22-35'	\$3,932.65
HCC131377	Case-IH, 2010, 2020, 20' & shorter	\$2,010.50
<b>Case-IH 3020</b>		
HCC131532	Case-IH, 3020, 25-35'	\$4,164.90
HCC131533	Case-IH, 3020, 20'	\$2,176.30
<b>Honey Bee</b>		
HCC131385	Honey Bee, double eccentric	\$3,698.52
<b>John Deere 600 Series</b>		
HCC131374	John Deere, 600 series, 25' & longer (Will not fit Flex Draper)	\$4,304.25
HCC131375	John Deere, 600 series, 22' & shorter (Will not fit Flex Draper)	\$2,177.75
HCC131603	John Deere 640FD, 40'	\$3,661.93
<b>John Deere 900 Series</b>		
HCC131367	John Deere, 900 series, (serial # 645301-) 25' & longer	\$4,365.40
HCC131368	John Deere, 900 series, (serial # 645301-) 22' & shorter	\$2,729.40
<b>Massey Ferguson</b>		
HCC131388	Massey Ferguson, draper, double eccentric	\$3,872.05
HCC131384	Massey Ferguson, 1859, single eccentric	\$2,017.25
HCC131373	Massey Ferguson, 8200 series, 25-35'	\$3,954.25
HCC131396	Massey Ferguson, 8200 series, 20' & shorter	\$2,060.10
<b>New Holland</b>		
HCC131378	New Holland, 970-973, 25' & longer	\$4,083.55
HCC131379	New Holland, 970-973, 22' & shorter	\$2,128.65
HCC131376	New Holland 72C, 74C, 22-35'	\$3,932.65
HCC131377	New Holland 72C, 74C, 20' & shorter	\$2,010.50
HCC131400	New Holland 73C, 22' & longer	\$4,018.05
HCC131401	New Holland 73C, 20' & shorter	\$2,095.95
HCC131532	New Holland 740CF, 22' & longer	\$4,164.90
HCC131533	New Holland 740CF, 20' & shorter	\$2,176.30

# HCC FLIP REEL KIT

## Eliminate Crop Wrapping Around Bat Tubes



The Flip Reel Kit enhances reel performance with its tine flipping action that feeds heavy-duty crops into the header.

**Particularly effective with canola and other tall, stringy crops**

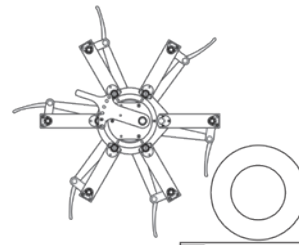

**HCC Flip Reel**

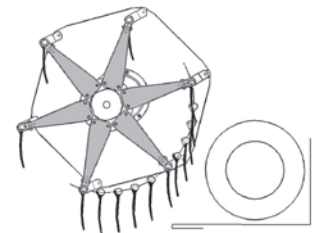

**Standard Reel**

Installation is easy and can be done on equipment you already own. You can install it yourself in a few hours.

Designed as a retro-fit for all HCC tube-type reels built since 1990. ML 4-1/2" tine spacing or Level II 6" tine spacings are designed to work with the Flip Reel Kit.

- Designed to fit HCC tube type reels built since 1990
- Fits Honey Bee headers equipped with HCC tube-type



HCC Flip Reel Kit		
Product ID	Product Description	Price
<b>AGCO</b>		
HCC031515	AGCO, 400, 500, 800, 8000 series, 25' & longer	\$2,490.54
HCC031520	AGCO, 400, 500, 800, 8000 series, 22' & shorter	\$1,352.96
HCC031510	AGCO, 8200, 9250 series, 25' & longer	\$2,707.42
HCC031521	AGCO, 8200, 9250 series, 22' & shorter	\$1,460.69
HCC031511	AGCO, 5100, 5200 draper, 25' & longer	\$2,558.40
HCC031522	AGCO 5100, 5200 draper, 22' & shorter	\$1,386.91
<b>Case-IH</b>		
HCC031516	Case-IH, 1010, 1020, 3020, 25' & longer	\$2,517.08
HCC031520	Case-IH, 1010, 1020, 3020, 22' & shorter	\$1,352.96
HCC031517	Case-IH, 2010, 2020, 25' & longer	\$2,517.08
HCC031523	Case-IH, 2010, 2020, 22' & shorter	\$1,378.06
<b>Honey Bee</b>		
HCC031357	Honey Bee, clamp mounted, 25' & longer	\$2,744.30
HCC031513	Honey Bee, bracket mounted, 25' & longer	\$2,770.87
<b>John Deere</b>		
HCC031518	John Deere, 600 flex series, 900 draper, 25' & longer	\$2,633.64
HCC031524	John Deere, 600 flex series, 22' & shorter	\$1,419.36
HCC031519	John Deere, 900 series, 25' & longer	\$3,351.50
HCC031525	John Deere, 900 series, 22' & shorter	\$2,295.15
HCC031365	John Deere, flex draper; 630FD, 635FD, 730FD, 735FD	\$2,687.71
HCC031351	John Deere, flex draper; 640FD, 645FD, 740FD, 745FD	\$2,677.02
<b>New Holland</b>		
HCC031515	New Holland, 971, 973, 25' & longer	\$2,490.54
HCC031520	New Holland, 971, 973, 22' & shorter	\$1,352.96
HCC031517	New Holland 72C, 74C, 25' & longer	\$2,517.08
HCC031523	New Holland 72C, 74C, 22' & shorter	\$1,378.06
HCC031515	New Holland 73C, 25' & longer	\$2,490.54
HCC031520	New Holland 73C, 22' & shorter	\$1,352.96
HCC031516	New Holland 740 CF, 25' & longer	\$2,517.08
HCC031520	New Holland 740 CF, 22' & shorter	\$1,352.96
<b>End Shield Kit (Recommended)</b>		
HCC031591	End Shield Kit, 25' & longer	\$868.84
HCC031600	End Shield Kit, 22' & shorter	\$495.60

## HCC REPLACEMENT REEL BUNDLES

HCC Replacement Reel Bundle				
Make	Model	Length	Product ID	Price
AGCO	400, 500, 700, 800, 8000 series	20'	HCC030541	\$2,318.20
		25'	HCC030561	\$2,750.00
		30'	HCC030581	\$3,545.16
		35'	HCC032082	\$3,850.00
	7200/ 8200/ 9250	20'	HCC030541	\$2,318.20
		25'	HCC030561	\$2,750.00
30'		HCC030581	\$3,545.16	
Case-IH	1020 (1)	20'	HCC030541	\$2,318.20
		25'	HCC030561	\$2,750.00
		30'	HCC030581	\$3,545.23
	2010/2020	20'	HCC030540	\$2,576.40
		25'	HCC030560	\$3,000.48
		30'	HCC030580	\$3,337.86
		35'	HCC032023	\$5,125.36
		3020	25'	HCC030562
	30'		HCC030582	\$3,569.64
	35'		HCC032023	\$5,125.35

HCC Replacement Reel Bundle				
Make	Model	Length	Product ID	Price
John Deere	900F	20'	HCC031956	\$2,320.08
		25'	HCC030562	\$2,847.79
		30'	HCC030580	\$3,337.83
	600F	20'	HCC030542	\$2,352.12
		25'	HCC030562	\$2,847.79
		30'	HCC030582	\$3,569.64
New Holland	72C/74C	20'	HCC030540	\$2,576.40
		25'	HCC030560	\$3,000.48
		30'	HCC030580	\$3,337.83
		35'	HCC032023	\$5,125.36
	740CF	25'	HCC030562	\$2,847.79
		30'	HCC030582	\$3,569.64
		35'	HCC032023	\$5,125.35

1) For Case-IH headers 1998 and newer with serial #JJC0315001 & CBJ023003 & up  
Please call for complete Reel replacement options for other models not listed above

If, for any reason, you are in need of a replacement reel, please consider HCC Replacement Reel Bundles. HCC Replacement Reel Bundles consist of the reel's center tube and the six bat tubes with the tines already installed.

- Lower Weight
- Stronger Construction
- Increased Visibility
- More Effective Crop Movement

Please note that the HCC Replacement Reel Bundles only fit HCC manufactured Level II reels which are defined by 6" tine spacing.

# MAY WES POLY SKID SHOES

## PUT MORE CROP IN THE COMBINE!

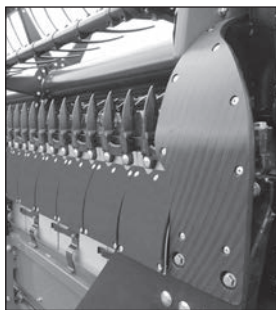

Run your head closer to the ground without pushing and piling soil, leaving little to no crop in the field.

**Even in Wet, Sticky Conditions**

Machine cut from solid sheets of solid virgin UHMW poly and formed to fit your head.

**Designed for a perfect fit.**

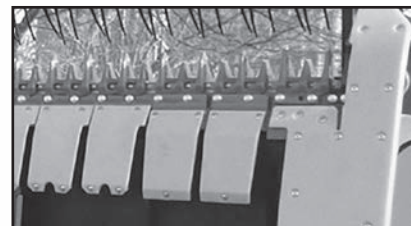

- Sold in complete kits, but are also available as individual replacement parts

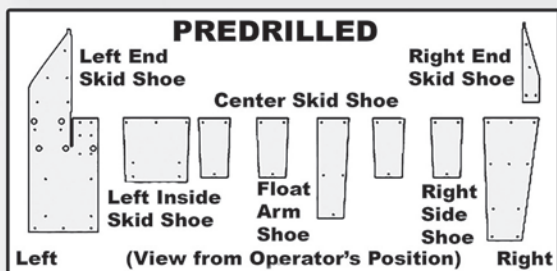

- Available as Predrilled or Undrilled for Easy Replacement

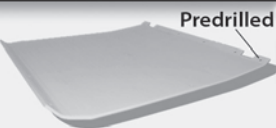

- Predrilled skid shoes are counter bored, allowing rivets or bolts to be recessed into the skid shoes

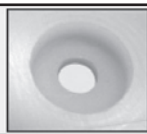

### Predrilled and Undrilled for Easy Replacement

**PREDRILLED:** Computerized drilling of counterbored holes makes them with .01" of factory drilled holes, making replacement easy and saving hours of labor compared to undrilled skid shoes. Counterboring holes allow for rivets or bolts to be recessed into skid shoes, keeping soil from building up on bolts or rivets.

**UNDRILLED:** Choose undrilled skid shoes when you need to match holes already drilled in metal shoes. For accuracy in drilling new poly skid shoes to match previous holes drilled, just position new shoes on factory metal shoe. Shine a light from behind the drilled metal shoe through white poly skid shoe. The light will shine through the hole, providing a marker for the placement of the new hole.

### May Wes Poly Skid Shoes

Make/Model/Thickness	Length	Product ID	Kit Price
AGCO Series III (pre-1987) 1/4" Pre-drilled	13'	MYW080183	\$465.00
	15'	MYW080186	\$515.00
	16'	MYW080189	\$530.00
	18'	MYW080192	\$552.00
	20'	MYW080195	\$650.00
	22'	MYW080198	\$690.00
AGCO 400, 500, 700/700C, 800/800C, 7000, 8000, Series III (1987 & newer) 1/4" Pre-drilled	24'	MYW080201	\$730.00
	13'	MYW081678	\$465.00
	15'	MYW081677	\$515.00
	16'	MYW081676	\$530.00
	18'	MYW081675	\$555.00
	20'	MYW081674	\$640.00
	22'	MYW081673	\$690.00
	24'	MYW081672	\$730.00
	25'	MYW081671	\$730.00
	30'	MYW081669	\$950.00
AGCO 7200/8200 1/4" Pre-drilled	20'	MYW083511	\$699.00
	25'	MYW083512	\$799.00
	30'	MYW083513	\$950.00
	35'	MYW083514	\$1,100.00
AGCO 9250 (AHD01001-CHD01100) High Profile 9250 (AHD01101-FHD01100) Low Profile High profile is determined by having 2-3/8" rise Low profile is determined by having 1" rise 1/4" Pre-drilled	25'	MYW083503	\$799.00
	30'	MYW083504	\$940.00
	35'	MYW083505	\$1,080.00
	40'	MYW083506	\$1,205.00
AGCO 9250 (CHD01101-FHD01100) High Profile High profile is determined by having 2-3/8" rise 1/4" Pre-drilled	25'	MYW083507	\$799.00
	30'	MYW083508	\$940.00
	35'	MYW083509	\$1,080.00
	40'	MYW083510	\$1,205.00
AGCO 9250 (after FHD01101) High Profile High profile is determined by having 2-3/8" rise 1/4" Pre-drilled	25'	MYW083572	\$799.00
	30'	MYW083573	\$940.00
	35'	MYW083574	\$1,080.00
	40'	MYW083575	\$1,205.00

Continued on next page.

# MAY WES POLY SKID SHOES

Make/Model/Thickness	Length	Product ID	Kit Price	Make/Model/Thickness	Length	Product ID	Kit Price	
<b>AGCO</b> 1/4" Pre-drilled 9250 (after FHD01101) Low Profile Low profile is determined by having 1" rise	25'	MYW083576	\$799.00	<b>Case-IH 2062</b> (before CCC0015328) <b>MacDon 974</b> (2005 & before) <b>New Holland 84C</b> (before PPP01119) 3/8" Pre-drilled	30'	MYW082577	\$1,140.00	
	30'	MYW083577	\$940.00		36'	MYW082576	\$1,240.00	
	35'	MYW083578	\$1,080.00	<b>Case-IH 2062</b> (after CCC0015328) <b>MacDon 974</b> (2006 & after) <b>New Holland 84C</b> (after PPP01119) 3/8" Pre-drilled		30', 36'	MYW083502	\$485.00
	40'	MYW083579	\$1,205.00					
<b>AGCO</b> 9255 (prior to serial number HHD01101) 1/4" Pre-drilled	25'	MYW083678	\$889.00		<b>Case-IH 3020 - single drive</b> <b>New Holland 740CF - single drive</b> 3/8 Molded Centers 1/4" Center/Ends Pre-Drilled	20'	MYW083317	\$478.00
	30'	MYW083679	\$1,050.00			25'	MYW083316	\$574.00
	35'	MYW083680	\$1,220.00	30'		MYW083315	\$670.00	
	40'	MYW083681	\$1,390.00	35'		MYW083314	\$766.00	
25'	MYW083894	\$889.00	<b>Case-IH 3020 - double drive</b> <b>New Holland 740CF - double drive</b> 3/8 Molded Centers 1/4" Center/Ends Pre-Drilled	20'		MYW083561	\$478.00	
30'	MYW083895	\$1,050.00		25'	MYW083560	\$574.00		
35'	MYW083896	\$1,220.00		30'	MYW083559	\$670.00		
40'	MYW083897	\$1,390.00		35'	MYW083558	\$766.00		
<b>AGCO</b> 9255 (after serial number HHD01101) Standard Skid 1/4" Pre-drilled	45'	MYW083898	\$1,490.00	<b>Case-IH 3020 - double drive</b> <b>New Holland 740CF - double drive</b> 3/8 Molded Centers 1/4" Center/Ends Pre-Drilled	20'	MYW083561	\$478.00	
	25'	MYW083899	\$889.00		25'	MYW083560	\$574.00	
	30'	MYW083900	\$1,050.00		30'	MYW083559	\$670.00	
	35'	MYW083901	\$1,220.00		35'	MYW083558	\$766.00	
	40'	MYW083902	\$1,390.00		<b>Case-IH 3152, 3162</b> <b>New Holland 840CD, 880CF</b> 3/8 Molded Centers 1/4" Center/Ends Pre-Drilled	25'	MYW083470	\$601.00
45'	MYW083903	\$1,490.00	30'	MYW083473		\$706.00		
<b>AGCO</b> 9255 (after serial number HHD01101) Low Skid 1/4" Pre-drilled	15'	MYW081735	\$402.00	35'		MYW083474	\$839.00	
	16.5'	MYW081736	\$447.00	40'		MYW083475	\$964.00	
	17.5'	MYW081737	\$495.00	45'		MYW083476	\$1,150.00	
	20'	MYW081738	\$542.00	<b>Case-IH 2142, 2152, 2162</b> <b>MacDon D50, D60, FD70</b> <b>New Holland 82C, 83C, 86C</b> 3/8" Pre-drilled	30', 35', 40', 45'	MYW083490	\$314.00	
	22.5'	MYW081739	\$589.00					
	25'	MYW081740	\$636.00					
30'	MYW081741	\$707.00						
20'	MYW082183	\$727.00	<b>MacDon</b> 974 (2005 & before) 3/8" Pre-drilled		21'			MYW083493
25'	MYW082180	\$895.00		25'	MYW083494	\$911.00		
30'	MYW082179	\$1,054.00	<b>MacDon</b> 974 (2006 & newer) 3/8" Pre-drilled	21', 25'	MYW083501	\$199.00		
20'	MYW082913	\$726.00						
25'	MYW082912	\$895.00	<b>Claas/Lexion/Caterpillar</b> F900, F750, F530, F525, F30, F20 1/4" Pre-drilled	15'	MYW082015	\$620.00		
30'	MYW082911	\$1,054.00		17'	MYW082014	\$695.00		
20'	MYW082917	\$726.00		20'	MYW082013	\$820.00		
25'	MYW082916	\$895.00		25'	MYW082012	\$1,025.00		
30'	MYW082915	\$1,057.00		30'	MYW082011	\$1,195.00		
20'	MYW082923	\$726.00	<b>New Holland</b> 973/73C 1/4" Pre-drilled	13'	MYW082187	\$483.00		
25'	MYW082922	\$895.00		15'	MYW082186	\$555.00		
20'	MYW082921	\$726.00		16'	MYW082185	\$581.00		
25'	MYW082920	\$895.00		18'	MYW082184	\$663.00		
30'	MYW082919	\$1,057.00		20'	MYW082183	\$727.00		
35'	MYW082918	\$1,240.00	22'	MYW082182	\$796.00			
<b>Case-IH 2052</b> (before CCC0014710) <b>MacDon 973</b> (2005 & before) 3/8" Pre-drilled	21'	MYW083495	\$714.00	24'	MYW082181	\$866.00		
	25'	MYW083496	\$834.00	25'	MYW082180	\$895.00		
	30'	MYW083497	\$996.00	30'	MYW082179	\$1,054.00		
	36'	MYW083498	\$1,160.00					
	39'	MYW083499	\$1,440.00					

Continued on next page.

# MAY WES POLY SKID SHOES

May Wes Poly Skid Shoes							
Make/Model/Thickness	Length	Product ID	Price/Ea	Make/Model/Thickness	Length	Product ID	Price/Ea
<b>John Deere</b> 200F 1/4" Pre-drilled Also available in 3/8"	13'	MYW081066	\$660.00	<b>John Deere</b> 200F 3/8" Pre-drilled Also available in 1/4"	13'	MYW090110	\$754.00
	15'	MYW081065	\$683.00		15'	MYW090109	\$790.00
	16'	MYW080858	\$707.00		16'	MYW090107	\$825.00
	18'	MYW080020	\$730.00		18'	MYW090106	\$895.00
	20'	MYW080024	\$764.00		20'	MYW090105	\$969.00
	22'	MYW080792	\$770.00		22'	MYW090104	\$990.00
	24'	MYW080552	\$801.00		24'	MYW090102	\$1,075.00
<b>John Deere</b> 900F 1/4" Pre-drilled Also available in 3/8"	13'	MYW081066	\$660.00	<b>John Deere</b> 900F 3/8" Pre-drilled Also available in 1/4"	13'	MYW090110	\$754.00
	15'	MYW080016	\$511.00		15'	MYW090108	\$830.00
	18'	MYW080020	\$730.00		18'	MYW090106	\$895.00
	20'	MYW080024	\$764.00		20'	MYW090105	\$969.00
	22'	MYW080171	\$680.00		22'	MYW090103	\$990.00
	24'	MYW080552	\$801.00		24'	MYW090102	\$1075.00
	25'	MYW080036	\$804.00		25'	MYW090101	\$1150.00
	30'	MYW080040	\$868.00		30'	MYW090100	\$1255.00
<b>John Deere</b> 600F 1/4" Pre-drilled Also available in 3/8"	18'	MYW082641	\$395.00	<b>John Deere</b> 600F 3/8" Pre-drilled Also available in 1/4"	18'	MYW090073	\$475.00
	20'	MYW082468	\$410.00		20'	MYW090072	\$492.00
	22'	MYW083310	\$445.00		22'	MYW090074	\$560.00
	25'	MYW082467	\$462.00		25'	MYW090071	\$602.00
	30'	MYW082466	\$580.00		30'	MYW090070	\$707.00
	35'	MYW082465	\$638.00		35'	MYW090069	\$820.00
<b>John Deere</b> 600FD 2012 1/4" Pre-drilled Also available in 3/8"	30'	MYW083631	\$577.00	<b>John Deere</b> 600FD 2012 3/8" Pre-drilled Also available in 1/4"	30'	MYW090083	\$754.00
	35'	MYW083632	\$625.00		35'	MYW090084	\$820.00
	40'	MYW083633	\$778.00		40'	MYW090085	\$895.00
Draper Skid Plate sold separately		MYW042196	\$336.00	Draper Skid Plate sold separately		MYW042196	\$336.00
<b>John Deere</b> 600FD 2013/2014 1/4" Pre-drilled Also available in 3/8"	30'	MYW083585	\$579.00	<b>John Deere</b> 600FD 2013/2014 3/8" Pre-drilled Also available in 1/4"	30'	MYW090082	\$754.00
	35'	MYW083567	\$675.00		35'	MYW090075	\$849.00
	40'	MYW083568	\$770.00		40'	MYW090076	\$933.00
Draper Skid Plate sold separately		MYW042196	\$336.00	Draper Skid Plate sold separately		MYW042196	\$336.00
<b>John Deere</b> 600FD 2015 1/4" Pre-drilled Also available in 3/8"	30'	MYW083634	\$577.00	<b>John Deere</b> 600FD 2015 3/8" Pre-drilled Also available in 1/4"	30'	MYW090086	\$754.00
	35'	MYW083635	\$675.00		35'	MYW090087	\$820.00
	40'	MYW083636	\$779.00		40'	MYW090088	\$984.00
	45'	MYW083637	\$866.00		45'	MYW090089	\$1,085.00
Draper Skid Plate sold separately		MYW042196	\$336.00	Draper Skid Plate sold separately		MYW042196	\$336.00
<b>John Deere</b> 600FD, 700FD 2016 & Newer After s/n 785000 1/4" Pre-drilled Also available in 3/8"	30'	MYW083672	\$577.00	<b>John Deere</b> 600FD, 700FD 2016 & Newer After s/n 785000 3/8" Pre-drilled Also available in 1/4"	30'	MYW090090	\$754.00
	35'	MYW083673	\$675.00		35'	MYW090091	\$820.00
	40'	MYW083674	\$779.00		40'	MYW090092	\$895.00
	45'	MYW083675	\$866.00		45'	MYW090093	\$984.00
Draper Skid Plate sold separately		MYW042289	\$347.00	Draper Skid Plate sold separately		MYW042289	\$347.00

# POLY AUGER FINGERS

**Keep your Auger Feeding Smoothly and Efficiently with NO Harm to the Combine!**

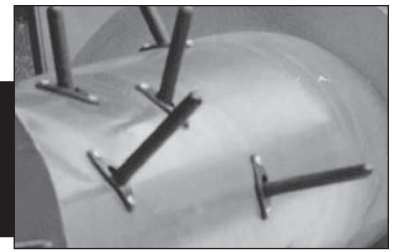

## The Common Sense Auger Finger Replacement Choice

The May Wes Poly Retractable Fingers are an ideal alternative to metal fingers because they are far less damaging when a metal finger breaks and is fed through the combine.



### No Harm to Your Combine!

Bent metal fingers can gouge and poke through the auger. Broken metal fingers do costly damage to the drum and thrasher system. The advantage of poly fingers over metal is when the poly fingers eventually break, the poly will disintegrate as it passes through the combine and will not damage the internal workings (i.e. rotors and cylinders).

### Strong & Resilient

May Wes Poly Retractable Fingers will not fray with heavy usage. These fingers are flexible and will bend past the breaking point of metal fingers.



**If they do break, the poly will disintegrate as it passes through the combine and will not damage the threshing system.**



No Harm to Combine



HIGH-IMPACT Strength



Poly Doesn't Rust!

Retractable Poly Fingers				
Make	Model	Product ID	Description	Price/Ea
AGCO	700, 800, 7000, 7200, 8000, 8200	MYW082620	Poly Finger Kit - 10-15/16" Long	\$14.40
		MYW083439	Poly Finger Kit - 11-7/16" Long	\$14.40
Case-IH	1010, 1020, 2142, 2152, 2162	MYW080646	Poly Finger Kit - 9-1/8" Long	\$14.40
	1020, 2020 - before CBJ020701	MYW083468	Poly Finger Kit - 10-5/8" Long	\$14.40
	2020 - CBJ020701 & later	MYW082481	Poly Finger Kit - 10-5/8" Long	\$14.40
	2042, 2052, 2062	MYW082615	Poly Finger Kit - 7-7/16" Long	\$16.80
	3016, 3020, 3152, 3162	MYW082131	Poly Finger Kit - 10-1/4" Long	\$14.40
Challenger	FH, FHB	MYW082620	Poly Finger Kit - 10-15/16" Long	\$14.40
		MYW083439	Poly Finger Kit - 11-7/16" Long	\$14.40
John Deere	200, 900	MYW080650	Poly Finger Kit - 10-1/4" Long	\$14.40
	600F, 600R, 600P	MYW082475	Poly Finger Kit - 11-1/4" Long	\$14.40
	600FD, 600D, 700FD	MYW083527	Poly Finger Kit - 10-5/8" Long	\$14.40
Lexion	V525, V530, V535, V540, V750, V900, F25, F30, F525, F530, F750, F900, G30, G525	MYW083472	Poly Finger Kit - 9-5/8" Long	\$14.40
	V1050, V1200, F535, F540, G535, G540	MYW082925	Poly Finger Kit - 10-7/8" Long	\$14.40
MacDon	872/873 combine adapter (with 11" auger drum)	MYW082615	Poly Finger Kit - 7-7/16" Long	\$16.80
	872/873 combine adapter (with 12" auger drum)	MYW083382	Poly Finger Kit - 8-3/16" Long	\$16.80
	FM100 Float Module	MYW083831	Poly Finger Kit - 9-1/8" Long	\$16.80
	CA20/CA25 combine adapter	MYW080646	Poly Finger Kit - 9-1/8" Long	\$14.40
New Holland	740CF, 760CG, 790CP, 880CF, 840CD	MYW082131	Poly Finger Kit - 10-1/4" Long	\$14.40
	74C - before PNL01781	MYW083468	Poly Finger Kit - 10-5/8" Long	\$14.40
	74C - PNL01781 & later	MYW082481	Poly Finger Kit - 10-5/8" Long	\$14.40
	82C, 83C, 86C	MYW080646	Poly Finger Kit - 9-1/8" Long	\$14.40
	84C	MYW082615	Poly Finger Kit - 7-7/16" Long	\$16.80
	971, 972, 973	MYW081366	Poly Finger Kit - 10-1/4" Long	\$14.40

All poly finger kits include poly finger, guide and hardware.

# POLY AUGER TROUGH LINERS

## ...For Grain Heads and Corn Heads

### Do You Have Holes in Your (Grain or Corn) Head?

May Wes Poly Auger Trough Liners provide a smooth, slick surface for the grain to flow out PLUS guard against corrosion!



**Grain Head**

### Durable Poly Won't Rust!

When the head is covered with the 1/8" thick UHMW poly May Wes Auger Trough Liners, wet grain and moisture will not cause corrosion.

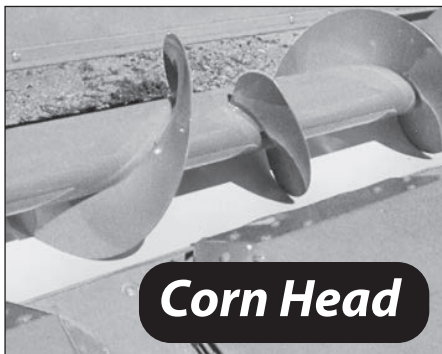

**Corn Head**



**Liner**

1/8" thickness

Grain Head

- Exceptional wear characteristics of the ultra high molecular weight (UHMW) poly.
- The 1/8" thick UHMW poly lining is much easier to replace than factory metal. Simply bolt and rivet into place.

**At 1/8" thick UHMW poly, May Wes auger trough liners cover the full length of the floor under the auger, not just the feed opening.**

### Grain Head Auger Trough Liners

Make/Model	Product ID	Length	Price/Ea
Case-IH 1020 series	MYW083715	15'	\$490.00
	MYW083716	17.5'	\$577.00
	MYW083716	20'	\$577.00
	MYW083717	22.5'	\$732.00
	MYW083718	25'	\$783.00
Case-IH 2020 series	MYW083719	30'	\$953.00
	MYW083725	20'	\$577.00
	MYW083726	25'	\$783.00
	MYW083727	30'	\$953.00
John Deere 200, 900 series	MYW083728	35'	\$1,056.00
	MYW083593	13' - 16'	\$490.00
	MYW083594	18' - 20'	\$608.00
	MYW083595	22' - 24'	\$721.00
	MYW083596	25'	\$783.00
John Deere 600 series	MYW083597	30'	\$953.00
	MYW082706	20'	\$577.00
	MYW082707	22'	\$691.00
	MYW082708	25'	\$773.00
	MYW082709	30'	\$902.00
New Holland 74C series	MYW082710	35'	\$1,056.00
	MYW083725	20'	\$577.00
	MYW083726	25'	\$783.00
	MYW083727	30'	\$953.00
	MYW083728	35'	\$1,056.00

### Save Money on Repairs!

#### Cornhead Auger Trough Liners

Make/Model	Product ID	Description	Prc/Ea
Case-IH 900, 1000 series	MYW082643	4-row	\$320.00
	MYW082644	6-row	\$366.00
	MYW082645	8-row	\$500.00
	MYW082646	12-row	\$732.00
Case-IH 2200, 2400, 3200, 3400	MYW082647	4-row	\$320.00
	MYW082648	6-row	\$366.00
	MYW082649	8-row	\$500.00
	MYW082650	12-row	\$732.00
New Holland 96C, 96D, 98C, 98D	MYW083850	16-row	\$958.00
	MYW083854	6-row	\$366.00
	MYW083855	8-row	\$500.00
	MYW083856	12-row	\$732.00
Case-IH 2600, 4200, 4400	MYW083857	16-row	\$958.00
	MYW082075	4-row	\$320.00
	MYW082076	6-row	\$366.00
	MYW082077	8-row	\$505.00
John Deere 40/90 series	MYW082078	12-row	\$737.00
	MYW082727	6-row	\$366.00
	MYW082728	8-row	\$500.00
John Deere 600 series	MYW082729	12-row	\$732.00



# POLY AUGER TROUGH LINERS for Grain Tanks



Provides a smooth, slick surface for the grain to flow out PLUS guard against corrosion! Full coverage of the trough underneath the auger keeps grain in the tank for maximum harvest potential.



**Save Money on Grain Tank Trough Repair:**  
Protect the area in your grain tank that needs it the most and wears out the quickest. Install the May Wes Grain Tank Auger Trough Liner over new or worn tank floor.

**Grain Tank Repair & Coverage:**  
Instead of trying to cut, weld or patch the floor of your grain tank, use the May Wes Grain Tank Auger Trough Liner. These kits contain all you need to cover the worn areas under the auger(s). Lead edges are covered with stainless steel for smooth flow of grain.

Grain Tank Auger Trough Liners			
Make	Product ID	Description	Prc/Ea
<b>Case-IH</b> (covers both augers)	MYW083313	7230, 7240, 7250, 8230, 8240, 8250, 9230, 9240, 9250	\$515.00
	MYW083383	5088, 5130, 6088, 6130, 7088, 7130	\$515.00
	MYW083311	7010, 7120, 8010, 8120, 9120	\$567.00
	MYW082582	2300 series, 2588	\$510.00
	MYW082581	2100 series	\$510.00
	MYW082580	1600 series (except 1620)	\$510.00
<b>Gleaner</b>	MYW082579	1400 series	\$510.00
	MYW082642	All Models	\$284.00
<b>John Deere</b> (covers both augers)	MYW083327	9660STS, 9670STS, 9760STS, 9770STS, 9860STS, 9870STS, S550, S660, S670, S680, S690	\$515.00
	MYW083199	9560STS, 9570STS, 9650STS, 9750STS	\$515.00
	MYW082584	9450, 9550, 9560, 9600, 9610, 9650, 9660	\$557.00
	MYW082583	9400, 9410, 9500, 9510	\$557.00
<b>New Holland</b>	MYW082799	All single auger TR Models	\$284.00
	MYW083399	NH CR920, CR940, CR960, CR970, CR980, CR9040, CR9070	\$567.00

## CROP DIVIDERS



UHMW poly grain platform Crop Dividers, with marker rods, are sold as pairs. Replacement marker rods are available.



Crop Dividers		
Case-IH	Product ID	Price/Pair
Red Crop Divider with Rods	MYW083843	\$212.00
John Deere - 900F, 600F, 600D, 600FD	Product ID	Price/Pair
Green Crop Divider with Rods	MYW083841	\$212.00
Replacement Parts	Product ID	Price/Pair
Marker Rod, Pair	MYW042432	\$19.00

## AIR FILTER BLASTER *Reduce fuel consumption and extend the life of filters.*

- Increases engine performance and equipment life.
- Safe for filters.
- Distribution of air only allows a maximum of 48 psi to come out of any one air jacket in the Filter Blaster.



Air Filter Blaster		
Product ID	Description	Price
MYW083685	Air Filter Blaster, 6" Rotor included	\$299.00
Optional Accessories		
MYW042311	3" Rotor, 3" - 4.5" inside diameter filter	\$59.00
MYW042312	4.5" rotor, 4.5" - 6" inside diameter filter	\$59.00
MYW042313	6" rotor, 6" - 9" inside diameter filter	\$59.00
MYW042314	9" rotor, 9" and greater inside diameter filter	\$59.00
MYW042315	12" extended shaft, filters with depths above 26"	\$59.00
MYW042316	Cage Assembly, 3" rotor	\$59.00

# MAY WES INNOVATIONS

## Snout Savers - Prevent damage to your combine snouts!

MayWes UHMW Poly Snout Savers' curved design for hollow points is used to lift the point off the ground and create a larger surface area for ground contact. This feature **keeps the snout from digging into the dirt and wrinkling the snout**, which results in costly replacement or repair and downtime. When ordering Snout Savers, you will need one fewer inside snout savers than the total number of rows on your corn head. For example: A 12-row corn head will need 11 inside (center) snout savers and two outside (end) snout savers.

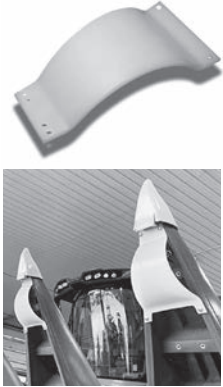
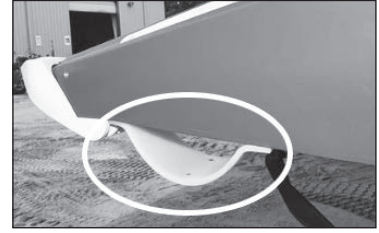

Poly Snout Savers		
Case-IH	Product ID	Price
2200, 2400, 3200, 3400; Inside Snout	MYW083795	\$27.00
2200, 2400, 3200, 3400; Outside Snout	MYW083797	\$27.00
2200, 2400, 3200, 3400; Inside Snout with cutout for Height Control Sensor	MYW083796	\$27.00
2200, 2400, 3200, 3400; Outside Snout with cutout for Height Control Sensor	MYW083798	\$27.00
Metal Head; Inside Snout	MYW080837	\$27.00
Metal Head; Outside Snout	MYW080838	\$27.00
4400; Inside Snout	MYW083928	\$27.00
4400; Outside Snout	MYW083929	\$27.00

Poly Snout Savers		
Drago	Product ID	Price
Inside Snout	MYW082606	\$27.00
Outside Snout	MYW082607	\$27.00
John Deere	Product ID	Price
600, 700, C-Series 30"; Inside Snout	MYW083624	\$27.00
600, 700, C-Series 20", 22"; Inside Snout	MYW084030	\$27.00
600, 700 Series 30"; Outside Snout	MYW083625	\$27.00
600, 700 Series 20", 22"; Outside Snout	MYW084032	\$27.00
Metal Head; Inside Snout	MYW080839	\$27.00
Metal Head; Outside Snout	MYW080840	\$27.00
Poly Heads	Product ID	Price
Inside Snout	MYW082606	\$27.00
Outside Snout	MYW082607	\$27.00

## ROW DIVIDER SHIELDS

These UHMW poly Row Divider Shields protect row dividers on John Deere 600/700/C Series Chopping Heads. They reinforce the divider and cover worn spots as well as heightens the effectiveness of the divider's purpose and eliminates windrowing of the trash. The pre-drilled shield is a fraction of the cost of replacing the OEM part.

John Deere Row Divider Shields			
Description	Row Spacing	Product ID	Price/Ea
600/700 Series (OEM #AXE19102)	20"/22"	MYW042124	\$65.00
600/700 Series (OEM #AXE18146)	30"	MYW042125	\$65.00
C-Series	20"/22"	MYW042759	\$75.00
C-Series	30"	MYW042760	\$75.00



## EAR SAVERS

**UHMW poly Ear Savers prevent loose corn ears from sliding over the gathering chains to the ground.** May Wes Ear Savers will not fold back like factory ear gates. They stay rigid, working

like a gate, yet soft enough to let through without knocking the ears off the corn stalk. May Wes Ear Savers are made of black soft polyurethane and last longer than OEM rubber.



Corn Head Ear Savers			
Case-IH	Row Size	Product ID	Price/Ea
4400 Inside	30"	MYW084400	\$18.00
4400 Outside		MYW084401	\$18.00
4400 Inside	20"/22"	MYW084402	\$18.00
4400 Outside		MYW084403	\$18.00
2200, 2400, 2600, 3200, 3400	30"	MYW082045	\$18.00
800, 900, 1000, & GVL Poly Head	30"	MYW080652	\$18.00
Cat/Lexion	Row Size	Product ID	Price/Ea
Cat/Lexion Inside	-	MYW082625	\$18.00
Cat/Lexion Outside	-	MYW082873	\$31.00
GVL Poly Snouts	Row Size	Product ID	Price/Ea
GVL Poly Snouts	-	MYW042880	\$18.00

Corn Head Ear Savers			
John Deere	Row Size	Product ID	Price/Ea
600 Series Inside	22"	MYW082780	\$18.00
600 Series Outside		MYW082779	\$18.00
600 Series Inside	30"	MYW082715	\$18.00
600 Series Outside		MYW082714	\$18.00
90 Series Poly Head; 1998 & Newer	30"	MYW082002	\$18.00
90 Series Poly Head Inside; 1997 & Older	30"	MYW082059	\$18.00
90 Series Poly Head Outside; 1997 & Older		MYW082060	\$18.00
40 Series	30"	MYW080664	\$18.00
New Holland	Row Size	Product ID	Price/Ea
96C, 96D, 98C, 98D, 996	-	MYW082045	\$18.00

# DUCK FOOT PADDLE TINES



## Unique Clip-on Paddle Tines



- Field-tested, with proven data, to reduce header loss
- Increased ground speed
- Clears the cutter bar and feeds crop more evenly for better threshing
- Fast and easy to install and remove
- Slower reel speed for less crop damage
- Unique clip system secures the paddle tine to the reel pipe
- Beneficial for lentils, soybeans, wheat, straight cut canola, flax, all cereals, hay, barley and more



## Increased Capacity

Increase the surface area to pull crop onto the platform and into the combine:

Area covered with factory tines: 14%

Area covered with Duck Foot Paddle tines added: 47%

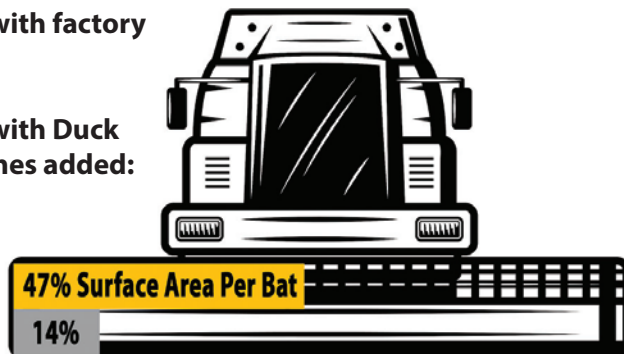

**DF1MD - 5 BAT** Fits: **Case-IH** 2142, 2152, 2162; **John Deere** 430, 435, 440; **MacDon** FD, FD1, FD2 and D series; **New Holland** 82C, 83C, 86C

Length	Tines	Product ID	Price
-	1	DFT011000	\$12.99
25'	115	DFT150250	\$1,421.40
30'	140	DFT150300	\$1,730.40
35'	165	DFT150350	\$2,039.40
40'	190	DFT150400	\$2,348.40
45'	215	DFT150450	\$2,657.40
50'	240	DFT150500	\$2,966.40

**DF2HC - 6 BAT** Fits: **AGCO** 300 - 8000, 8200, 9250; **Case-IH** 1010, 1020, 2010, 2020, 3020; **Claas Maxflex & Maxflo** 750-1200, G525, G530, F525, F530, F750, F900, S450-900; **John Deere** 900R, 900F, 600R, 600F, 600FD (before s/n 784,999); **Massey Ferguson** 5100, 5200, 7000, 7200, 8000, 8200, 9250, 9700, 9750, 9800, 9850; **New Holland** 71C, 72C, 73C, 74C, 88C, 92C, 94C, 740, 971, 973

Length	Tines	Product ID	Price
-	1	DFT012000	\$12.99
20'	110	DFT260200	\$1,359.60
25'	140	DFT260250	\$1,730.40
30'	170	DFT260300	\$2,101.20
35'	200	DFT260350	\$2,472.00
40'	230	DFT260400	\$2,842.80
45'	260	DFT260450	\$3,213.60
50'	290	DFT260500	\$3,584.40

**DF3PT - 5 BAT** Fits **MacDon** 973, 974; **Geringhoff**, 2020 & newer TruFlex and TruFlex Razor

Length	Tines	Product ID	Price
-	1	DFT013000	\$12.99
25'	115	DFT350250	\$1,421.40
30'	140	DFT350300	\$1,730.40
35'	165	DFT350350	\$2,039.40
40'	190	DFT350400	\$2,348.40
45'	215	DFT350450	\$2,657.40
50'	240	DFT350500	\$2,966.40

**DF3PT - 6 BAT** Fits: **Case-IH** 3152, 3162, 4152, 4162, DH213, DH253, DH303, DH363, DH403, 4F30, 4F40, 4F45, 4R30, 4R35, 4R40, 4R45; **Craty**; **GTS**; **John Deere** 600FD (after s/n 785,000), 700FD, HDR, HDF, RDF; **MacDon** 972; **New Holland** 880CF, 840CD

Length	Tines	Product ID	Price
-	1	DFT013000	\$12.99
20'	110	DFT360200	\$1,359.60
25'	140	DFT360250	\$1,730.40
30'	170	DFT360300	\$2,101.20
35'	200	DFT360350	\$2,472.00
40'	230	DFT360400	\$2,842.80
45'	260	DFT360450	\$3,213.60
50'	290	DFT360500	\$3,584.40

**DF4CL - 6 BAT** Fits: **Claas Convio** 2017 & newer

Length	Tines	Product ID	Price
-	1	DFT014000	\$12.99
20'	110	DFT460200	\$1,359.60
25'	140	DFT460250	\$1,730.40
30'	170	DFT460300	\$2,101.20
35'	200	DFT460350	\$2,472.00
40'	230	DFT460400	\$2,842.80
45'	260	DFT460450	\$3,213.60
50'	290	DFT460500	\$3,584.40

# KERNEL KEEPER



**If you save just two kernels per ear per acre, that's one bushel per acre!**



**Before Kernel Keeper**



**After Kernel Keeper:**  
Fewer kernels dislodged from the ear



## CUSHION, CAPTURE, COLLECT:

The dampeners **CUSHION** the impact of the ear on the deck plate absorbing the energy, resulting in fewer kernels dislodged from the ear.

The rails **CAPTURE** any dislodged kernels before they can slide between the deck plates.

The FingerBrushes sweep the captured kernels, **COLLECTING** into the auger bed and into the combine.

- Easy retrofit to current deck plates.
- All hardware is included for installation along with drill bit and rail alignment guides.

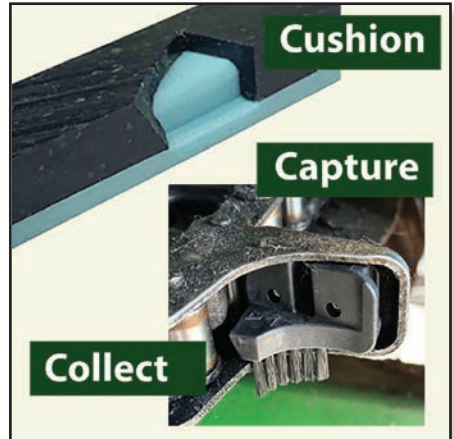

Kernel Keeper		
Two Rows Per Kit		
John Deere 40, 90 Series	Product ID	Price/Kit
40 Series, 90 Series	KKR601201	\$390.00
John Deere 600 series without Row Max Gathering Chain	Product ID	Price/Kit
600 Series (non-Row Max)	KKR611201	\$390.00
John Deere 600 series with Row Max, 700 series, C-series	Product ID	Price/Kit
600 Series with Row Max Update, 700 Series, C series	KKR621201	\$390.00

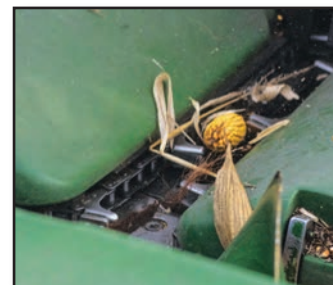

# MAY WES G4 STALK STOMPERS

Knock down corn stalks ahead of combine and tractor tires, preventing tire stubble damage.



Make/Model	Description	12" Shoe w/ Toolbar	Price	12" Shoe w/o Toolbar	Price
<b>AGCO Challenger 3000</b>	2-row	MYW084711	\$1,803.00	MYW084716	\$1,597.00
	4-row	MYW084712	\$2,395.00	MYW084717	\$2,112.00
	6-row	MYW084713	\$3,142.00	MYW084718	\$2,962.00
	8-row	MYW084714	\$3,966.00	MYW084719	\$3,683.00
	12-row	MYW084715	\$5,279.00	MYW084720	\$4,816.00
<b>Capello Diamant</b>	2-row	MYW084819	\$2,241.00	MYW084824	\$2,035.00
	4-row	MYW084820	\$2,910.00	MYW084825	\$2,781.00
	6-row	MYW084821	\$3,657.00	MYW084826	\$3,425.00
	8-row	MYW084822	\$4,584.00	MYW084827	\$4,275.00
	12-row (rigid head only)	MYW084823	\$5,794.00	MYW084828	\$5,511.00
<b>Capello Quasar</b>	2-row	MYW084739	\$1,751.00	MYW084745	\$1,571.00
	4-row	MYW084740	\$2,369.00	MYW084746	\$2,112.00
	6-row	MYW084741	\$3,116.00	MYW084747	\$2,962.00
	8-row	MYW084742	\$3,966.00	MYW084748	\$3,657.00
	12-row	MYW084743	\$5,305.00	MYW084749	\$4,816.00
	16-row	MYW084744	\$6,232.00	MYW084750	\$5,588.00
<b>Case-IH 900/1000 Series 6 Row ONLY</b>	2-row	MYW084981	\$1,288.00	MYW084857	\$1,133.00
	4-row	MYW084983	\$1,932.00	MYW084859	\$1,751.00
	6-row	MYW084984	\$2,884.00	MYW084860	\$2,678.00
<b>Case-IH 900/1000 Series 8 Row ONLY</b>	2-row	MYW084985	\$1,751.00	MYW084861	\$1,545.00
	4-row	MYW084986	\$2,421.00	MYW084862	\$2,215.00
	6-row	MYW084989	\$3,245.00	MYW084865	\$3,039.00
	8-row	MYW084990	\$3,708.00	MYW084866	\$3,528.00
<b>Case-IH 2600, 4200, 4400 series New Holland 99C, 980 series</b>	2-row	MYW084891	\$2,009.00	MYW084898	\$1,854.00
	4-row	MYW084892	\$2,653.00	MYW084899	\$2,498.00
	6-row	MYW084893	\$3,296.00	MYW084900	\$3,090.00
	8-row	MYW084894	\$3,914.00	MYW084901	\$3,554.00
	12-row	MYW084895	\$5,202.00	MYW084902	\$4,790.00
	12-row (folding heads)	MYW084943	\$6,155.00	MYW084944	\$5,717.00
	16-row	MYW084896	\$6,979.00	MYW084903	\$6,464.00
	18-row	MYW084897	\$7,700.00	MYW084904	\$7,185.00

Chart continued on next page.

## Stalks Damaging Your Tires?

Today's corn stubble is as tough as nails. Don't let it damage your expensive combine tires and tracks. May Wes G4 Stalk Stompers feature heavy duty Ultra-High-Molecular-Weight poly shoes and high quality steel.

UHMW is one of the slickest and toughest plastics in the world, and is even used to make armor plating!

## G4 Stalk Stompers' Advantages

- **Simplified Design**  
Torsion spring to handle shock
- **Closed tail** prevents accidental reverse damage
- **Reduced Weight by 25%**  
½" thick UHMW poly instead of steel
- **12" shoe width**  
optimal width for knocking down stalks
- **Easier to remove** and reposition for transport



# MAY WES G4 STALK STOMPERS



**Winner of the 2018 Made in Minnesota Manufacturing Awards Best Game-Changing B2C Product!**



**FARMERS TESTED.  
FARMERS APPROVED.**

*"I ran the May Wes G4 Stalk Stompers on 2,500 acres with heavier down pressure at 5.5 mph. The new light-weight stomper shoes wore better than the Quick Disconnect version.*

*I like the ease in handling the shoes and the ability to rotate the shoes for storage on the head. The G4 is less bulky and a cleaner, more efficient stalk leveling design."*

- Josh K. Hutchinson, MN

Make/Model	Description	12" Shoe w/ Toolbar	Price	12" Shoe w/o Toolbar	Price	
<b>Case-IH</b> 2200, 2400, 3200, 3400 <b>New Holland</b> 96C, 98C, 98D, 996 6 Row ONLY	2-row	MYW084908	\$1,751.00	MYW084924	\$1,494.00	
	4-row (all rows except 3 & 4)	MYW084909	\$2,272.00	MYW084925	\$2,060.00	
	6-row	MYW084911	\$3,477.00	MYW084927	\$3,193.00	
<b>Case-IH</b> 2200, 2400, 3200, 3400 <b>New Holland</b> 96C, 98C, 98D, 996 8 & 12 Row ONLY	2-row	MYW084912	\$2,009.00	MYW084928	\$1,829.00	
	4-row - no coverage under feeder-house	MYW084913	\$2,601.00	MYW084929	\$2,447.00	
	4-row	MYW084914	\$2,704.00	MYW084930	\$2,550.00	
	6-row	MYW084915	\$3,528.00	MYW084931	\$3,296.00	
	6-row - no coverage under feeder-house	MYW084916	\$3,451.00	MYW084932	\$3,219.00	
	8-row	MYW084917	\$4,223.00	MYW084933	\$3,914.00	
	12-row	MYW084918	\$5,588.00	MYW084934	\$5,073.00	
	16-row	Available Upon Request				
	18-row	Available Upon Request				
<b>Drago</b> Series I & II	2-row	MYW084653	\$1,700.00	MYW084662	\$1,468.00	
	4-row	MYW084654	\$2,189.00	MYW084663	\$2,009.00	
	6-row (requires MYW041958)	MYW084655	\$3,013.00	MYW084664	\$2,859.00	
	8-row	MYW084656	\$3,863.00	MYW084665	\$3,554.00	
	12-row (20", 22", 30" spacing)	MYW084657	\$5,073.00	MYW084666	\$4,584.00	
	12-row (folding heads)	MYW084659	\$5,871.00	MYW084668	\$5,382.00	
	16-row	MYW084660	\$6,103.00	MYW084669	\$5,614.00	
	18-row	MYW084661	\$6,979.00	MYW084670	\$6,438.00	
	<b>Drago</b> GT Series	2-row	MYW084639	\$1,803.00	MYW084646	\$1,623.00
		4-row	MYW084640	\$2,369.00	MYW084647	\$2,138.00
6-row		MYW084641	\$3,245.00	MYW084648	\$2,987.00	
8-row		MYW084642	\$3,966.00	MYW084649	\$3,708.00	
8-row (folding heads)		MYW084802	\$4,172.00	MYW084803	\$3,914.00	
12-row		MYW084643	\$5,305.00	MYW084650	\$4,867.00	
12-row (folding heads)		MYW084753	\$5,794.00	MYW084754	\$5,253.00	
16-row		MYW084644	\$6,335.00	MYW084651	\$5,665.00	
18-row		MYW084645	\$6,979.00	MYW084652	\$6,489.00	
<b>Fantini</b>		2-row	MYW084729	\$1,803.00	MYW084734	\$1,597.00
	4-row	MYW084730	\$2,369.00	MYW084735	\$2,112.00	
	6-row	MYW084731	\$3,142.00	MYW084736	\$2,962.00	
	8-row	MYW084732	\$3,966.00	MYW084737	\$3,683.00	
	12-row	MYW084733	\$5,176.00	MYW084738	\$4,713.00	
<b>Geringhoff</b> Horizon Series	2-row	MYW084685	\$1,313.00	MYW084692	\$1,133.00	
	4-row	MYW084686	\$1,931.00	MYW084693	\$1,726.00	
	6-row	MYW084687	\$2,884.00	MYW084694	\$2,678.00	
	8-row	MYW084688	\$3,863.00	MYW084695	\$3,554.00	
	12-row	MYW084689	\$5,047.00	MYW084696	\$4,532.00	
	16-row	MYW084690	\$5,974.00	MYW084697	\$5,434.00	
<b>Geringhoff</b> <b>Patriot</b> <b>Northstar</b> <b>Rota Disc</b>	18-row	MYW084691	\$6,824.00	MYW084698	\$6,232.00	
	2-row	MYW084671	\$1,314.00	MYW084678	\$1,133.00	
	4-row	MYW084672	\$1,932.00	MYW084679	\$1,726.00	
	6-row	MYW084673	\$2,884.00	MYW084680	\$2,678.00	
	8-row	MYW084674	\$3,863.00	MYW084681	\$3,554.00	
	12-row	MYW084675	\$5,047.00	MYW084682	\$4,532.00	
	16-row	MYW084676	\$5,974.00	MYW084683	\$5,434.00	
18-row	MYW084677	\$6,901.00	MYW084684	\$6,361.00		

Continued on next page.

# MAY WES G4 STALK STOMPERS

Make/Model	Description	12" Shoe w/ Toolbar	Price	12" Shoe w/o Toolbar	Price
<b>Harvestec</b> 5000 6000	2-row	-	-	MYW084721	\$1,082.00
	4-row	-	-	MYW084722	\$1,932.00
	6-row	MYW084723	\$2,884.00	MYW084726	\$2,678.00
	8-row	MYW084724	\$3,863.00	MYW084727	\$3,528.00
	12-row	MYW084725	\$5,047.00	MYW084728	\$4,584.00
<b>John Deere</b> 443/493 643/693 843/893 1243/1293	2-row (2 outer rows)	MYW084965	\$1,751.00	MYW084973	\$1,545.00
	4-row (4 outer rows)	MYW084966	\$2,421.00	MYW084974	\$2,215.00
	6-row (4 outer & 2 inner rows)	MYW084968	\$3,348.00	MYW084976	\$3,090.00
	6-row (outer rows)	MYW084969	\$3,245.00	MYW084977	\$3,039.00
	8-row	MYW084970	\$3,708.00	MYW084978	\$3,425.00
	12-row	MYW084971	\$5,253.00	MYW084979	\$4,790.00
<b>John Deere</b> 606C, 706C 608C, 708C 612C, 712C 616C, 716C 618C, 718C	2-row	MYW084624	\$1,803.00	MYW084631	\$1,597.00
	4-row	MYW084625	\$2,369.00	MYW084632	\$2,112.00
	6-row	MYW084626	\$3,142.00	MYW084633	\$2,962.00
	8-row	MYW084627	\$3,914.00	MYW084634	\$3,683.00
	12-row	MYW084628	\$5,356.00	MYW084635	\$4,816.00
	12-row (folding heads)	MYW084870	\$5,768.00	MYW084871	\$5,253.00
	16-row	MYW084629	\$6,644.00	MYW084636	\$6,026.00
	18-row	MYW084630	\$6,979.00	MYW084637	\$6,412.00
<b>John Deere</b> C6R C8F, C8R C12F, C12R C16F, C16R C18F, C18R	2-row	MYW084767	\$1,957.00	MYW084779	\$1,751.00
	4-row	MYW084768	\$2,472.00	MYW084780	\$2,369.00
	6-row	MYW084769	\$3,168.00	MYW084781	\$2,962.00
	8-row	MYW084771	\$4,017.00	MYW084783	\$3,734.00
	12-row	MYW084772	\$5,408.00	MYW084784	\$4,996.00
	12-row (folding heads)	MYW084773	\$5,794.00	MYW084785	\$5,356.00
	16-row	MYW084774	\$7,185.00	MYW084786	\$6,721.00
	16-row (folding heads)	MYW084775	\$7,751.00	MYW084787	\$7,288.00
	18-row	MYW084776	\$7,803.00	MYW084788	\$7,313.00
	18-row (folding heads)	MYW084777	\$8,112.00	MYW084789	\$7,571.00
<b>Lexion</b>	2-row	MYW084699	\$1,803.00	MYW084705	\$1,597.00
	4-row	MYW084700	\$2,369.00	MYW084706	\$2,112.00
	6-row	MYW084701	\$3,142.00	MYW084707	\$2,962.00
	8-row	MYW084702	\$3,966.00	MYW084708	\$3,657.00
	12-row	MYW084703	\$5,176.00	MYW084709	\$4,713.00
	16-row	MYW084704	\$6,103.00	MYW084710	\$5,562.00
<b>MacDon</b> C-Series	2-row	-	-	MYW084756	\$1,082.00
	4-row	-	-	MYW084757	\$1,932.00
	6-row	MYW084758	\$2,884.00	MYW084761	\$2,678.00
	8-row	MYW084759	\$4,017.00	MYW084762	\$3,708.00
	12-row	MYW084760	\$5,228.00	MYW084763	\$4,738.00

To reduce cost, the 2x2 toolbar can be removed from the kit. This is standard 2x2 square 3/16" sidewall tubing.

**If you don't see the make and model of your cornhead, contact us at 800-368-7773 for possible availability.**



Based on farmer feedback, the G4 Stalk Stomper features a simplified and space-saving torsion design that eliminates the spring, chain, pivot bolt and other bulky features found in most Stalk Stompers, making it easier for one person to install, remove and reposition for transport or storage.

The G4 is more compact with an 11.5" shorter length than previous models, providing more clearance for track combines and hassle-free storage and transport on folding corn heads.



May Wes widened the G4's shoe to 12" for optimal stalk leveling and reduced its weight by 25 percent.

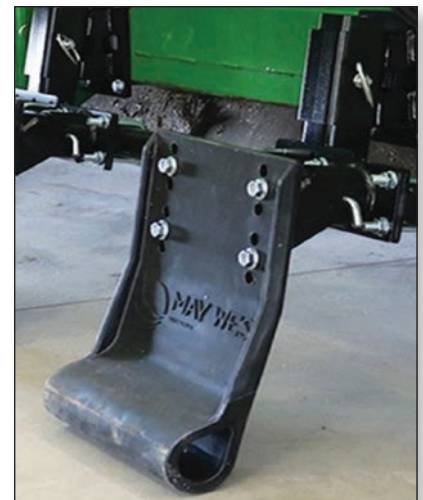

**MORE GRAIN  
IN THE BIN!**

**LESS IN  
THE FIELD!**



# BUSHEL PLUS SMARTPAN SYSTEM GRAIN LOSS MANAGEMENT SYSTEM



The Bushel Plus Smartpan System is precise, dependable, and designed to measure grain loss easily with any combine. With your safety in mind, all units are remote controlled and portable so that no wiring or bolts are needed to attach it to the combine. This magnetic drop pan can quickly and easily move from one combine to the other – no tools needed!

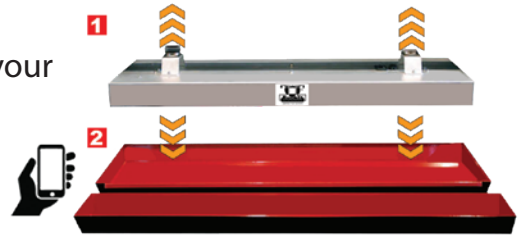

## Four Fast and Easy Steps to Measure your Loss and Put More Grain in the Bin!



**1 Mount**  
Attach the magnetic drop pan to any combine in seconds

**2 Drop**  
Safely release the drop pan using the remote or the SmartDrop app

**3 Separate**  
Clean the sample with the Bushel Plus Air Separator

**4 Calculate**  
Check your results with the SmartDrop App

**Savings from farmers have been reported anywhere from 2% to more than 10%.**

The Bushel Plus SmartPan System has revolutionized the checking-for-harvest-loss process. As featured on CORN WARRIORS USA – you can now quantify your grain loss and calibrate your loss monitor for immediate improvement! The Bushel Plus SmartPan System is PROVEN for corn, soybeans, and small grain such as wheat, oats, barley, canola and rice.

Harvest Lost:	
Before	After
8 BU/Acre Grain Loss	0.8 BU/Acre Grain Loss

**The Flagship: 40" BP System – with 40" long drop pans (wide & narrow) - BPS100401** The most popular system! Handy size to carry around in your pickup or grain truck — perfect when working with a lot of different combines. 40" is the ideal size to mount higher, under feederhouse, to avoid tall stalks or stubble. A good choice for corn and soybean growers.

**The Wide Setup: 60" BP System – with 60" long drop pans (wide & narrow) BPS100601** If you are a fan of windrowing straw when checking your grain loss and want to catch a sample from the entire width of your sieves then this is the fit for you.

**The BP Mini: 20" BP System – with 20" long drop pan (wide only) - BPS100200** Designed for use in 30" row crops when leaving high cut stubble (ex. corn & sorghum - falls in between stubble without tipping over). Also used with plot and research combines.

# BUSHEL PLUS SMARTPAN SYSTEM

**What's Included in the Kit:** BPS100401 and BPS100601 come with two different size (wide and narrow) drop pans for different stubble conditions – no tipping over in long stubble!

- Carrier (Attaches to the Combine)
- Wide Drop Pan
- Narrow Drop Pan
- Pan-Drop Remote/Lanyard
- Durable Field Scale
- Smart Charger
- Downloadable Bushel Plus App
- User Manual

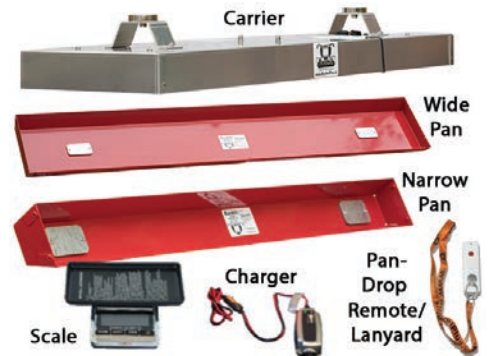

Bushel Plus SmartPan System			
System	Description	Product ID	Price/Each
The Flagship	40" SmartPan	BPS100401	\$1,975.00
The Wide Setup	60" SmartPan	BPS100601	\$2,175.00
The Mini	20" SmartPan (Chaff Deck Version)	BPS100200	\$998.00
Accessory			
Air Separator		BPS200101	\$765.00
Bushel Plus SmartPan System plus Air Separator			
System	Description	Product ID	Price/Each
The Flagship	40" SmartPan plus Air Separator	BPS200401	\$2,740.00
The Wide Setup	60" SmartPan plus Air Separator	BPS200601	\$2,940.00
The Mini	20" SmartPan plus Air Separator (Chaff Deck Version)	BPS200201	\$1,763.00

# TAILBOARD TRASH BLOWER TUBE

**Farmers Agree: "A Very Affordable Difference Maker!"**



The Tailboard Trash Blower Tube keeps crop residue from accumulating on the combine tailboard.

**No More Daily Tailboard Cleaning!**

- Keeps the tailboard free of crop residue
- Eliminates fire hazards



A tailboard, with the Tailboard Trash Blower Tube, after a full season of harvesting soybeans.



Without the Tailboard Trash Blower Tube



Installs in minutes, without any drilling or cutting

Tailboard Trash Blower Tube		
Product ID	Description	Price
SMT201600	Tailboard Trash Blower Tube, John Deere S650, S660, S670, S680, S690, S760, S770, S780, S790, S7 600, S7 700, S7 800, S7 900	\$169.00
SMT201900	John Deere X9 1000, X9 1100	\$185.00

- Since the tube is slotted to direct air across the tailboard, the tailboard stays clean at all times.
- The manufacturer tested it as 26 MPH wind at center of the tailboard compared to 0-5 MPH without.

**THE FIRST STEP IN A SUCCESSFUL  
HARVEST, IS A GREAT CUT!**

**EASY CUT II**  
by SCHUMACHER.

## Cutterbar Systems

### As far as U.S. Distribution, it All Started With S.I. Distributing

Despite all technological advances around the combine and platform, the cutting system is still the first part to touch your crop and determines your harvest success. The Schumacher cutting system is an essential component for successful combining and supports maximum performance of combine harvesters. EasyCut systems are deployed all around the world when it comes to harvesting soybeans, cereal and rice. All parts are bolted for easy handling and replacement.

In 1988, S.I. Distributing began selling the SCH Easy Cut cutting system, which was being manufactured in Germany for German made equipment. Along with Schumacher, S.I. Distributing adapted the parts to fit most combines, swathers, mower conditioners, and sickle bar mowers manufactured in the United States, S.I. Distributing was the first distributor in the U.S. for the Schumacher Company and today is still their largest aftermarket distributor in the nation.

### Superior Cutting, More Uptime and Less Maintenance

High quality spring steel guards, completely hardened sections and roller guides give the system durability and low maintenance. The EasyCut II system eliminates the need for any adjustments, meaning less downtime and provides high-cutting performance in the toughest conditions.

- **No Adjustments** - With the enclosed design of the guards, hold downs are eliminated, along with all the adjustments that come with them
- **Choices to Suit Every Harvest Condition** - Roller guides or wear plates; short or long guards; coarse, extra course, or fine tooth sickle sections
- **Easy Handling** - Most conversion kits and sectional knife assemblies can be shipped as a small parcel carrier



#### SCH Easy Cut II owners were asked:

#### **“What one feature convinced you to buy the Kit?”**

##### **Less friction -**

D.S., St. Marys, KS

##### **No hold downs needed -**

P.H., Lake City, MN

##### **No adjusting -**

R.B., South Hearst, ND

##### **Less wear on knife -**

C.R., Gibsonburg, OH

- **EasyCut II blunt guard eliminates spearing of residue**
- **SCH guards fully wrap around the backbone, increasing strength**
- **SCH guards are fully heat treated**
- **SCH sections are fully heat treated**
- **SCH sections will not bend**
- **SCH guards have two beveled cutting edges**
- **SCH rollers improve performance by reducing friction & vibration**

# SCH EASYCUT II CONVERSION KITS



## What's Included In Each Kit?

Each kit includes all the necessary parts to convert your current header into an Easy Cut II cutting system. Along with this, each kit includes installation instructions on how to assemble the kit.

Every conversion kit also includes 2 extra standard guards and a 10-pack of sections with mounting hardware.

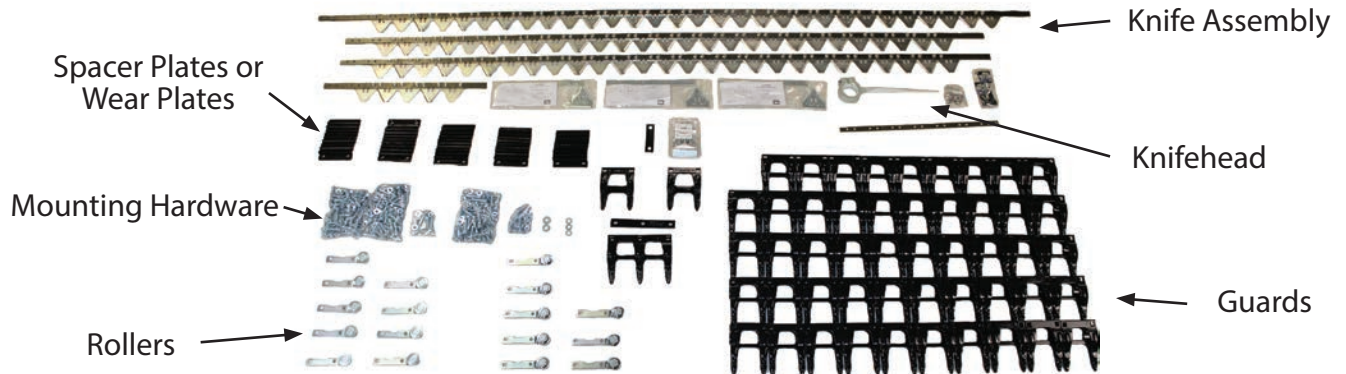

## SCH EASYCUT II OPTIONS



### Option 1) Roller Guide Conversion Kits

SCH roller guides greatly reduce the amount of force required from the knife drive to power the knife. On conventional cutting systems the knife runs against a wear plate. With the SCH roller guides, the knife runs against the top and bottom roller guides allowing the knife to move more freely. This also reduces the amount of wear on the knifeback. The top and bottom roller guides are alternated, which allows the knife to move more smoothly across the entire header.



**Top Roller - #SCP019035**



**Bottom Roller - #SCP019036**

Roller guide kits are a simple solution for end users that already have an SCH Easy Cut system with the conventional wear plates. These kits include the parts needed to convert an SCH wear plate cutting system to use the rollers guides. **Each roller guide kit includes:** top & bottom roller guides, spacer plates, and instructions.

**NOTE:** When installing a new roller guide kit on an existing SCH cutting system, a new knife assembly is recommended.

### Option 2) Wear Plate Conversion Kits

SCH wear plates have a similar concept to the conventional cutting systems on the market today but require less adjusting. The hardened wear plates support the knifeback from behind, while the section rides on top of the wear plate. This feature, along with using the SCH guard, creates a tight fit and eliminates the need for hold downs and any adjustments.

# SCH EASYCUT II CONVERSION KITS

Kit price includes all parts to convert to the **SCH EasyCut II SYSTEM**, including one pre-assembled knife with knifehead (without bearing), all guards and hardware, plus ten extra replacement sections with hardware and two extra guards. Please specify coarse (7 teeth per inch) or fine (11 teeth per inch) knife sections. Coarse is recommended for soybeans and alfalfa; fine is recommended for wheat and grasses. Also includes 10mm socket and 10mm wrench for section bolts.

**Note:** The ideal cutter bar speed is 540 RPM for optimum cutting performance.

SCH EasyCut Conversion Kit Prices							
Width	SCH Kit w/ Wear Plates	SCH Kit w/ Rollers	SCH Roller Guide Kit*	Width	SCH Kit w/ Wear Plates	SCH Kit w/ Rollers	SCH Roller Guide Kit*
7	\$944.00	\$1,029.00	\$123.00	21	\$1,989.00	\$2,233.00	\$335.00
8	\$1,012.00	\$1,105.00	\$128.00	21 DD	\$2,310.00	\$2,552.00	\$335.00
9	\$1,079.00	\$1,188.00	\$148.00	22	\$2,056.00	\$2,318.00	\$359.00
10	\$1,145.00	\$1,267.00	\$172.00	22 DD	\$2,375.00	\$2,638.00	\$359.00
11	\$1,213.00	\$1,343.00	\$172.00	22.5	\$2,116.00	\$2,387.00	\$359.00
12	\$1,287.00	\$1,433.00	\$198.00	24	\$2,183.00	\$2,471.00	\$378.00
12 DD	\$1,607.00	\$1,752.00	\$198.00	24 DD	\$2,503.00	\$2,790.00	\$378.00
13	\$1,357.00	\$1,510.00	\$213.00	25	\$2,243.00	\$2,537.00	\$401.00
14	\$1,442.00	\$1,612.00	\$229.00	25 DD	\$2,562.00	\$2,857.00	\$401.00
14 DD	\$1,763.00	\$1,930.00	\$229.00	27	\$2,362.00	\$2,692.00	\$425.00
15	\$1,536.00	\$1,712.00	\$245.00	30	\$2,522.00	\$2,874.00	\$483.00
16	\$1,612.00	\$1,796.00	\$263.00	30 DD	\$2,840.00	\$3,193.00	\$483.00
16 DD	\$1,930.00	\$2,114.00	\$263.00	35	\$2,790.00	\$3,204.00	\$563.00
16.5	\$1,653.00	\$1,846.00	\$263.00	35 DD	\$3,109.00	\$3,524.00	\$563.00
17	\$1,695.00	\$1,896.00	\$270.00	36	\$2,858.00	\$3,279.00	\$582.00
17.5	\$1,738.00	\$1,940.00	\$278.00	36 DD	\$3,177.00	\$3,599.00	\$582.00
18	\$1,780.00	\$1,989.00	\$278.00	39	\$3,100.00	\$3,626.00	\$632.00
18 DD	\$2,098.00	\$2,310.00	\$278.00	40	\$3,179.00	\$3,702.00	\$648.00
18.5	\$1,820.00	\$2,040.00	\$294.00	40 DD	\$3,498.00	\$4,020.00	\$648.00
19	\$1,865.00	\$2,084.00	\$312.00	42	\$3,310.00	\$3,855.00	\$676.00
20	\$1,931.00	\$2,166.00	\$312.00	45	\$3,476.00	\$3,889.00	\$707.00
20 DD	\$2,251.00	\$2,484.00	\$312.00	45 DD	\$3,796.00	\$4,209.00	\$707.00

\*Installing a roller guide kit on an existing SCH EasyCut cutting system requires a new knifeback.

Price Adjustments to SCH EasyCut Kits		
AGCO 5300, 5400 drapers	Add	\$200.00
Case-IH 3020, New Holland 740 grain platforms	Add	\$200.00
Case-IH 2052, 2062, 2152, 2162; 2 skid plates required per foot (SCP082817)	Add	\$37.52/ft
MacDon 973, 974, FD60, FD70, FD75, D60 (2006 & after) 2 skid plates required per foot (SCP082817)	Add	\$37.52/ft
New Holland 84C; 2 skid plates required per foot (SCP082817)	Add	\$37.52/ft
SCP083690: Optional 540 RPM, 11-1/2" backshaft pulley for Case-IH 1020 oil bath header.		\$111.00

SCH EasyCut Sickle Bar Mower Kit Prices		
Width	SCH Kit with Wear Plates	SCH Kit with Rollers
5	\$431.00	\$495.00
6	\$532.00	\$612.00
7	\$614.00	\$699.00
8	\$699.00	\$797.00
9	\$783.00	\$897.00
10	\$869.00	\$996.00

Kit price includes pre-assembled knife, without knifehead, all guards and hardware. Must re-use original equipment manufacturer (OEM) knifehead. No extra replacement parts are included. Please specify coarse (7 teeth per inch) or fine (11 teeth per inch) knife sections. Coarse is recommended for soybeans and alfalfa; fine is recommended for wheat and grasses.

# PRO CUT SECTIONS

Schumacher Pro Cut knife sections are completely thru-hardened, therefore extremely tough. **They don't bend.** Therefore, when hitting large stones or other objects, damage to guards is eliminated which is not the case with regular sections.



7-tpi

**Various Options**  
7-tpi, 11-tpi, or 4-tpi options available

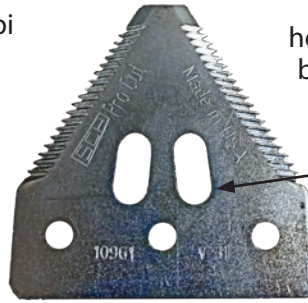

11-tpi

**Cut-Outs**  
help clean residue buildup and also reduces overall knife weight



4-tpi

SCH Pro Cut Replacement Knife Sections				
Description	Coarse 7-TPI	Fine 11-TPI	Extra Coarse 4-TPI	Price
Pro Cut Section (individual)	SCP010978	SCP010961	SCP010963	\$2.15
10-pack Pro Cut Sections (includes hardware)	SCP080502	SCP080504	SCP080506	\$27.94
Box of 25 Pro Cut Sections	SCP110978	SCP110961	SCP110963	\$53.78
Countersunk Pro Cut Section (individual)	SCP016223	SCP016222	n/a	\$3.78
2.5" Section, for center divider assemblies (individual)	SCP018792	SCP018334	n/a	\$7.96
Non-Serrated Half Section (individual)	SCP013935			\$1.84
<b>Coarse (7 teeth per inch) recommended for soybeans and alfalfa.</b>				
<b>Fine (11 teeth per inch) recommended for wheat and grasses.</b>				
<b>Extra Coarse (4 teeth per inch)</b>				

SCH Pro Cut Knife Section Hardware		
Description	Product ID	Price
Serrated Section Bolt, 6mm x 16mm (individual)	SCP010931	\$0.26
Countersunk Section Bolt, 6mm x 16mm (individual)	SCP010045	\$0.27
Flange Nut, 6mm (individual)	SCP013961	\$0.11
Serrated Section Bolt & Nut 50 Pack, 6mm x 16mm (hardware for 25 sections)	SCP080503	\$19.03



SCP010931



SCP010045



SCP013961

## ROLLER GUIDES



### Top Roller

holds knife straight to prevent section from tipping downward



### Bottom Roller

reduces vibration and wear of knifeback, prevents section from tipping upward

SCH roller guides offer a high performance alternative to the standard wear plates that are used on many machines in the market today.

Almost all SCH Easy Cut systems can be updated with roller guides.

SCH Roller Guides		
Product ID	Description	Price
SCP019035	SCH top roller guide, bolts on top of guard and edge of roller rides on top of section.	\$22.50
SCP019036	SCH bottom roller guide, bolts on top of guard and edge of roller rides on bottom of section.	\$22.50

# SPRING STEEL GUARDS

## What makes the SCH Easy Cut II steel guard so special?

The SCH Easy Cut guard is manufactured using a special alloy steel. A subsequent special hardening process gives the guard extremely high hardness, durability and wear life. The angled cutting edges of the guard holds the crop material better, resulting in a cleaner cut and a better flow of material. This also results in less power needed to cut the material.

### Blunt Tip

less spearing of crop and residue

### Increased Stability

guard is bolted on top and bottom of cutterbar, increasing the durability against all impacts

### Top & Bottom Cutting Edge

double cutting edges for balanced knife guidance

### Smooth Knife Movement

design of guard makes it possible to insert knives with connector bars already mounted



## REPLACEMENT SCH GUARDS

Description	Short 5-1/4" Long	Long 6-1/8" Long	Price/ Each
12mm 2-point guard	SCP017744	SCP016500	\$26.97
12mm 2-point open top guard	SCP017750	SCP010701	\$45.35
12mm 2-point open top center guard	SCP018051	SCP010637	\$47.51
12mm 3-point guard	SCP019092	SCP016503	\$54.00

Description	Short 5-1/4" Long	Long 6-1/8" Long	Price/ Each
14mm 2-point guard	SCP017745	SCP016501	\$26.97
14mm 2-point open top guard	SCP017751	SCP010702	\$45.35
14mm 2-point open top center guard	SCP018052	SCP010638	\$47.51
14mm 3-point guard	SCP019093	SCP016504	\$54.00

Description	Short 5-1/4" Long	Long 6-1/8" Long	Price/ Each
17mm 2-point guard	SCP017746	SCP016502	\$26.97
17mm 2-point open top guard	SCP017752	SCP010703	\$45.35
17mm 2-point open top center guard	SCP018053	SCP010639	\$47.51
17mm 2-point head guard, for Case-IH 1020*	SCP019158	---	\$49.67
17mm 3-point guard	SCP019094	SCP016505	\$54.00
*For most other models an open top guard can be used instead of a head guard.			

### Short

### Long



SCP017744



SCP016500



SCP017745



SCP016501



SCP017746



SCP016502

# GUARD WEAR INDICATIONS

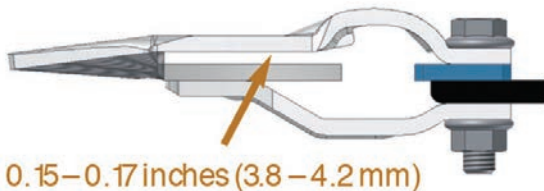

0.15–0.17 inches (3.8 – 4.2 mm)  
Optimal gap!



>0.21 inches (5.4 mm)  
Guard has to be changed!

## Check for Guard Wear

When cutting parts wear down, performance drops fast. You'll see slower cutting speeds, more crop loss, higher fuel use, added machine stress, and avoidable down-time.

### Guard wear. Check the gap.

Guards should be checked regularly for wear. A new guard has a gap of 0.15 – 0.17 inches (3.8 – 4.2 mm).

Wear with over 0.21 inches (5.4 mm) causes floating of the knife in the cutting gap. The rounded cutting edges will cause increased power requirements to drive the knife.

#### Identify Your Guard

Mark	Guard Type	Color
2	12mm Guard	Black
4	14mm Guard	Red
7	17mm Guard	Gray



**SCH Multi-Tool:** Call 800-368-7773 to receive a free SCH multi-tool to check your SCH guards.

## Check for Guard Wear



## SCH PARTS BAGS / PACKAGES

S.I. Distributing has created parts packages to make it easier for you to stock spare parts. These kits include a range of spare parts that vary depending on the platform. For SCP399100 and SCP399200, the bag is included at no charge.

**SCH Parts Bags are customized for your make and model.**



SCH Roller Guides Parts Bag



SCH Double Drive Parts Package



SCH Wear Plate Parts Bag

Product ID	Description	Price
SCP399100	SCH Wear Plates Parts Bag	\$325.00
SCP399200	SCH Roller Guides Parts Bag	\$410.00
SCP399300	SCH Double Drive Parts Package	\$195.00

NOTE: Please specify make, model and length of platform.

# SCH EASYCUT II REPLACEMENT PARTS

## SCH Knife Hardware



SCH Knife Hardware		
Product ID	Description	Price
SCP010931	Bolt, 6mm x 16mm, for section	\$0.26
SCP010067	Bolt, 6mm x 18mm, for knifehead & connector	\$0.23
SCP016282	Bolt, 6mm x 20mm, for knifehead	\$0.53
SCP010071	Bolt, 6mm x 25mm, for knifehead & overlap strap	\$0.43
SCP010072	Bolt, 6mm x 28mm, for knifeheads with top strap	\$0.24
SCP010045	Bolt, countersunk, 6mm x 16mm	\$0.27
SCP013961	Nut, flange, 6mm	\$0.11
SCP010937	Insert, for connector kit	\$0.81
SCP010941	Insert, for knifehead	\$0.44

## SCH Knifehead Hardware Pack



SCH Knifehead Hardware Packs		
Product ID	Description	Price
SCP083601	Knifeheads with top strap	\$5.53
SCP083784	Knifeheads without top strap	\$5.53
SCP083731	AGCO 5300, 5400, 8200, 9250, 9255, 9300 knifeheads	\$5.53
SCP083730	Claas Maxflex knifeheads	\$5.53
SCP083889	John Deere 600F auger platform knifeheads	\$5.53

## SCH Double Drive Parts



SCH Double Drive Parts		
Product ID	Description	Price
SCP013666	Overlap strap, 2 sections	\$24.48
SCP013665	Overlap strap, 3 sections	\$24.48
SCP016222	Section, countersunk, fine	\$3.78
SCP016223	Section, countersunk, coarse	\$3.78
SCP016004	Overlap roller	\$36.58
SCP010662	Spacer bushing, overlap roller, 2 required	\$2.01
SCP010045	Bolt, countersunk, 6mm x 16mm	\$0.27
SCP010071	Bolt, 6mm x 25mm, for overlap strap	\$0.43
SCP013961	Nut, flange, 6mm	\$0.11
SCP083893	Center Divider	\$32.38

## SCH Knife Connector Kits



SCH Knife Connector Kits & Knifeback		
Product ID	Description	Price
SCP083607	Connector bar, includes two extra bolts & inserts	\$28.95
SCP080000	Connector bar with three sections, includes two extra bolts & inserts	\$32.70
SCP010067	Bolt, 6mm x 18mm, for knifehead & connector	\$0.23
SCP010937	Insert, for connector kit	\$0.81
N/A	SCH knifeback (without sections); average cost per foot	\$8.56

# SCH EASYCUT II REPLACEMENT PARTS

SCH Skid Plates		
Product ID	Description	Price
SCP082817	Skid Plate, fits model year 2006 and after, MacDon 973, 974, FD60, FD70, FD75, D60; Case-IH 2052, 2062, 2152, 2162; Required when installing SCH EasyCut on these headers.	\$18.76
SCP080549	Carriage bolt, 10-1.5mm x 45mm, SCH skid plate	\$1.31
SCP080550	Carriage bolt, 10-1.5mm x 55mm, for use with SCH skid plate	\$1.42
HDW220003	Nut, flange, 10-1.5mm, SCH skid plate	\$0.15

## SCH Skid Plates



SCH Spacer Plates, Used with Roller Guides		
Product ID	Description	Price
SCP015810	4mm, 2-hole, used with roller guide (brown)	\$1.48
SCP015811	4mm, 3-hole, used with roller guide (brown)	\$1.81
SCP015813	5mm, 2-hole, used with roller guide (blue)	\$1.61
SCP015814	5mm, 3-hole, used with roller guide (blue)	\$2.08
SCP015816	6mm, 2-hole, used with roller guide (black)	\$1.78
SCP015817	6mm, 3-hole, used with roller guide (black)	\$2.23
SCP083789	8mm, 2-hole used with roller guide (black)	\$3.69
SCP083790	8mm, 3-hole used with roller guide (black)	\$6.48

## SCH Spacer Plates

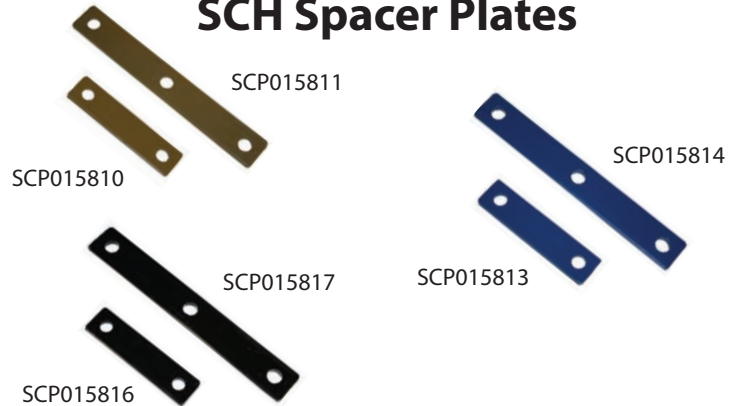

SCH Wear Plates		
Product ID	Description	Price
SCP017011	4mm, 2-hole, (brown)	\$3.08
SCP017014	4mm, 3-hole, (brown)	\$4.29
SCP010741	4mm, 4-hole, (brown)	\$4.15
SCP017012	5mm, 2-hole, (blue)	\$3.61
SCP017015	5mm, 3-hole, (blue)	\$4.82
SCP010742	5mm, 4-hole, (blue)	\$4.82
SCP017013	6mm, 2-hole, (black)	\$4.96
SCP017016	6mm, 3-hole, (black)	\$5.63
SCP010743	6mm, 4-hole, (black)	\$5.63
SCP010753	5mm, 4-hole, double sided, (blue)	\$7.43

## SCH Wear Plates



SCH Guard Hardware		
Product ID	Description	Price
HDW220029	Carriage bolt, 10-1.5mm x 35mm	\$0.40
HDW220002	Carriage bolt, 10-1.5mm x 40mm	\$0.45
HDW220015	Carriage bolt, 10-1.5mm x 45mm	\$0.50
HDW220016	Carriage bolt, 10-1.5mm x 50mm	\$0.55
HDW220027	Carriage bolt, 10-1.5mm x 55mm	\$0.65
HDW220034	Carriage bolt, 10-1.5mm x 60mm	\$0.70
SCP080549	Carriage bolt, 10-1.5mm x 45mm, for use with SCH skid plate	\$1.31
SCP080550	Carriage bolt, 10-1.5mm x 55mm, for use with SCH skid plate	\$1.42
SCP080560	Carriage bolt, 10-1.5mm x 45mm, AGCO 5300, 5400	\$2.75
SCP080561	Carriage bolt, 10-1.5mm x 60mm, AGCO 5300, 5400	\$2.92
HDW210221	Hex Head, 10-1.5mm x 40mm	\$0.36
HDW210222	Hex Head, 10-1.5mm x 45mm	\$0.46
HDW210223	Hex Head, 10-1.5mm x 50mm	\$0.52
HDW210225	Hex Head, 10-1.5mm x 60mm	\$0.56
HDW210224	Hex Head, 10-1.5mm x 70mm	\$0.66
HDW220003	Nut, flange, 10-1.5mm	\$0.15

## SCH Guard Hardware



# SCH KNIFE ASSEMBLIES

## Sectionalized Knife Assemblies

Today platforms are 30 feet or wider. Knife assemblies in one piece are very difficult to handle and transport. The SCH sectionalized knife assemblies eliminate this problem. The sectionalized knife assemblies are made up of individual sections - a head piece, middle pieces, a tail piece and connector bars. The longest single piece is less than 9 feet long and can be transported in a car, truck or shipped by courier.

The special connector bar joins the pieces fast and securely. SCH EasyCut sectional knife assemblies have only bolted sections. This also makes for a quick and easy replacement of individual knife sections or whole knife assembly segments. This is cost effective, and the individual parts are easy to replace.



- **Easy Handling**

Each knife assembly is packaged in a box less than 9' long

- **Universal Components**

Knives are made of different knife segments to make almost any length

- **Quick and Easy Replacement**

Each knife segment can be replaced by removing only a few bolts and nuts

- **High Strength Connection**

The connector bar is as strong as a piece of knifeback, acting like a single-piece knife

**Balanced Cutting Force**  
sections alternate one up / one down

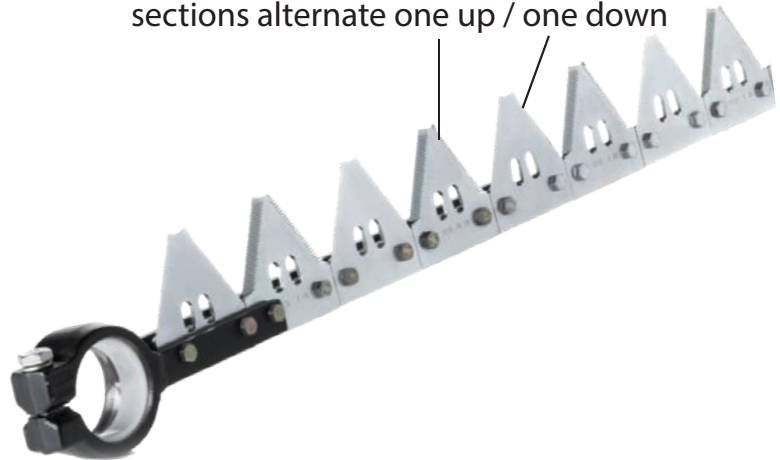

- **Small Parcel Shippable**
- **Ship by car or pickup truck**
- **Box is less than 9' long**
- **Easy handling**

### Features and Benefits:

- Sectional knife for flexible shipping options and easy handling
- High strength connector which performs like a single-piece knife
- Secure section mounting so sections remain tight on the knifeback
- Alternated section mounting for balanced cutting forces

# SCH KNIFE ASSEMBLIES

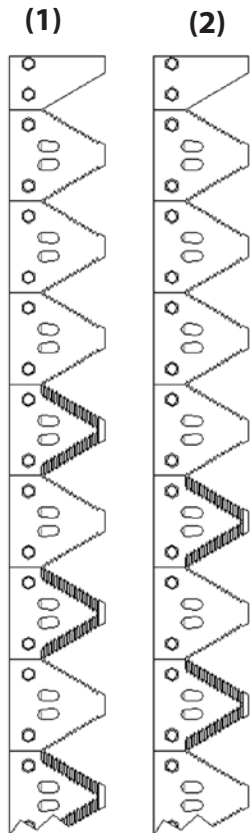

SCH Knife Assemblies Starting With A HALF Section					SCH Knife Assemblies Starting With A FULL Section				
Knife Assembly Length	Number of Sections	Original Knife Assembly Product ID (1)	Replacement Knife Assembly Product ID (2)	Price	Knife Assembly Length	Number of Sections	Original Knife Assembly Product ID (3)	Replacement Knife Assembly Product ID (4)	Price
7'	1/2 + 30	SCB210300	SCB210301	\$174.32	7'	30	SCB220300	SCB220301	\$174.32
8'	1/2 + 34	SCB210340	SCB210341	\$197.55	8'	34	SCB220340	SCB220341	\$197.55
9'	1/2 + 38	SCB210380	SCB210381	\$220.81	9'	38	SCB220380	SCB220381	\$220.81
10'	1/2 + 42	SCB210420	SCB210421	\$244.05	10'	42	SCB220420	SCB220421	\$244.05
11'	1/2 + 46	SCB210460	SCB210461	\$267.29	11'	46	SCB220460	SCB220461	\$267.29
12'	1/2 + 50	SCB210500	SCB210501	\$290.54	12'	50	SCB220500	SCB220501	\$290.54
13'	1/2 + 54	SCB210540	SCB210541	\$313.77	13'	54	SCB220540	SCB220541	\$313.77
15'	1/2 + 62	SCB210620	SCB210621	\$360.24	15'	62	SCB220620	SCB220621	\$360.24
16'	1/2 + 66	SCB210660	SCB210661	\$383.51	16'	66	SCB220660	SCB220661	\$383.51
17'	1/2 + 70	SCB210700	SCB210701	\$406.76	17'	70	SCB220700	SCB220701	\$406.76
18'	1/2 + 74	SCB210740	SCB210741	\$429.98	18'	74	SCB220740	SCB220741	\$429.98
20'	1/2 + 82	SCB210820	SCB210821	\$476.46	20'	82	SCB220820	SCB220821	\$476.46
22'	1/2 + 90	SCB210900	SCB210901	\$522.97	22'	90	SCB220900	SCB220901	\$522.97
24'	1/2 + 98	SCB210980	SCB210981	\$569.44	24'	98	SCB220980	SCB220981	\$569.44
25'	1/2 + 102	SCB211020	SCB211021	\$592.67	25'	102	SCB221020	SCB221021	\$592.67
27'	1/2 + 110	SCB211100	SCB211101	\$639.17	27'	110	SCB221100	SCB221101	\$639.17
30'	1/2 + 122	SCB211220	SCB211221	\$708.88	30'	122	SCB221220	SCB221221	\$708.88
35'	1/2 + 142	SCB211420	SCB211421	\$825.08	35'	142	SCB221420	SCB221421	\$825.08
36'	1/2 + 146	SCB211460	SCB211461	\$848.35	36'	146	SCB221460	SCB221461	\$848.35
40'	1/2 + 162	SCB211620	SCB211621	\$983.49	40'	162	SCB221620	SCB221621	\$983.49
45'	1/2 + 182	SCB211820	SCB211821	\$1,057.49	45'	182	SCB221820	SCB221821	\$1,057.49

Knifehead **NOT** Included  
NOTE: Add \$40 for all double drive kits.

- (1) & (3) Original knife assembly has the knife sections installed the same way as the original knife assembly.
- (2) & (4) Replacement knife assembly has the knife sections installed the opposite way as the original knife assembly.
- If unsure how the knife assembly starts, order the knife with a half section because the half section can be easily removed.
- Some knife assemblies may need cut to length to match original knife.
- Please specify coarse (7 teeth per inch) or fine (11 teeth per inch) knife sections.
- Coarse is recommended for soybeans and alfalfa; fine is recommended for wheat and grasses.

## SCH Knife Assembly Pieces and SCH Knifebacks

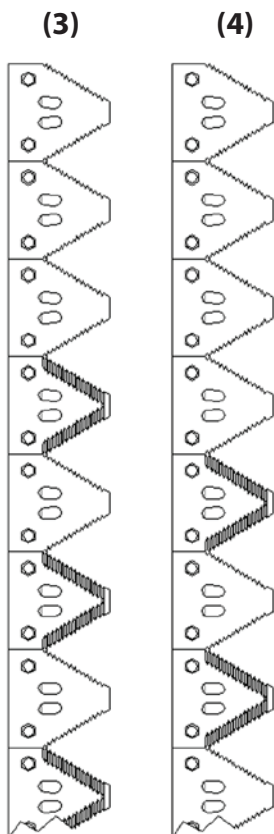









SCH Knife Assembly Pieces				
Product ID	Description	Length	Where Used	Price
SCB081602	Knife Assembly, #1 Bar	102.25"	Left hand drive end, 32 sections + 1/2 section, original	\$176.40
SCB081603	Knife Assembly, #1R Bar	99.25"	Left hand drive end, 31 sections + 1/2 section, replacement	\$171.58
SCB081604	Knife Assembly, #2 Bar	100.25"	Left hand drive end, 32 sections, original	\$172.95
SCB081605	Knife Assembly, #2R Bar	97.25"	Left hand drive end, 31 sections, replacement	\$168.15
SCB081606	Knife Assembly, #3 Bar	89.75"	Middle piece, 27 sections	\$155.19
SCB081607	Knife Assembly, #4 Bar	106.25"	Right hand end, 28 sections	\$166.74
SCB081608	Knife Assembly, #5 Bar	82.25"	Right hand end, 22 sections	\$130.38
SCB081609	Knife Assembly, #6 Bar	58.25"	Right hand end, 14 sections	\$93.82
SCB081610	Knife Assembly, #7 Bar	34.25"	Right hand end, 8 sections	\$49.51
SCB081611	Knife Assembly, #8 Bar	22.25"	Right hand end, 4 sections	\$28.39
SCB081612	Knife Assembly, #9 Bar	102.25"	Right hand drive end, 32 sections + 1/2 section, original	\$176.40
SCB081613	Knife Assembly, #9R Bar	99.25"	Right hand drive end, 31 sections + 1/2 section, replacement	\$176.40

Where used is in reference to left hand single-drive platforms.





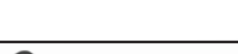







SCH Knifeback				
Product ID	Description	Length	Where Used	Price
SCP012022	Knifeback, #1 Bar	102.25"	Left hand end, drilled for 1/2 section, original	\$70.05
SCP012031	Knifeback, #1R Bar	99.25"	Left hand end, drilled for 1/2 section, replacement	\$68.77
SCP012023	Knifeback, #2 Bar	100.25"	Left hand end, drilled for full section, original	\$70.05
SCP012032	Knifeback, #2R Bar	97.25"	Left hand end, drilled for full section, replacement	\$68.77
SCP012024	Knifeback, #3 Bar	89.75"	Middle piece	\$65.96
SCP012025	Knifeback, #4 Bar	106.25"	Right hand end	\$74.16
SCP012026	Knifeback, #5 Bar	82.25"	Right hand end	\$57.72
SCP012027	Knifeback, #6 Bar	58.25"	Right hand end	\$49.45
SCP012030	Knifeback, #7 Bar	34.25"	Right hand end	\$23.91
SCP012028	Knifeback, #8 Bar	22.25"	Right hand end	\$16.50

Where used is in reference to left hand single-drive platforms.

# SCH EASYCUT II KNIFEHEADS



AGCO			
Product ID	Description	Price	
SCP002584	AGCO 8200, 9250, LH	\$168.66	
SCP002585	AGCO 9250, RH	\$168.66	
SCP081363	AGCO, 5100, 5200 draper, LH	\$186.48	
SCP013997	AGCO, 300 series flex, late model, LH; 400 series rigid, LH; 500, 800, 8000 series flex; 7/8" tie rod style, LH Note: Replaces OEM knifeheads with adjustable register	\$161.40	
SCP011222	AGCO, 300 series flex, late model, LH; 400 series rigid, LH; 500, 800, 8000 series flex; 3/4" tie rod style, LH; Note: Replaces OEM knifeheads with adjustable register	\$161.40	
SCP011195	AGCO, 300 series flex, early model bushing style, 300 & 700 rigid, LH	\$154.15	
SCP011252	AGCO, Hart Carter Series 2 floating cutter bar, LH	\$153.96	
SCP011279	AGCO, Hiniker floating cutter bar, LH	\$247.98	
SCP011266	AGCO, crank arm style, rigid, LH	\$155.24	

Case-IH			
Product ID	Description	Price	
SCP002401	Case-IH, 3020, LH	\$346.63	
SCP002896	Case-IH, 3020, double drive, RH	\$346.63	
SCP181379	Case-IH, 2142, 2152, 2162, all, 5 degree, LH, w/ bearing	\$195.00	
SCP181380	Case-IH, 2142, 2152, 2162, all, 5 degree, RH, w/ bearing	\$195.00	
SCP113667	Case-IH, 2142, 2152, 2162, 25' & shorter, 0 degree, LH, w/ bearing	\$156.56	
SCP113668	Case-IH, 2142, 2152, 2162, 25' & shorter, 0 degree, RH, w/ bearing	\$156.56	
SCP181373	Case-IH, 2052, 2062, 10 degree, LH, w/ bearing	\$195.00	
SCP181381	Case-IH, 2052, 2062, 10 degree, RH, w/ bearing	\$195.00	
SCP083815	Case-IH, 2020, S/N CBJ021301 and after, all "Y9ZL", LH	\$154.89	
SCP083816	Case-IH, 2020, S/N CBJ021301 and after, all "Y9ZL", double drive, RH	\$154.89	
SCP011213	Case-IH, 2020, S/N all "HAJ" & up to CBJ021301, LH	\$130.18	
SCP011214	Case-IH, 2020, S/N all "HAJ" & up to CBJ021301, double drive, RH	\$130.18	

Case-IH Continued			
Product ID	Description	Price	
SCP083792	Case-IH, 2020, double drive early style, LH	\$148.23	
SCP083793	Case-IH, 2020, double drive early style, double drive, RH	\$148.23	
SCP014266	Case-IH, 1010, 1020, LH	\$205.47	
SCP011226	Case-IH, 820, LH	\$152.02	
SCP011227	Case-IH, 810, 5" from center of knifehead bearing to center of first full section, LH	\$152.02	
SCP011252	Case-IH, 810, 4-1/4" from center of knifehead bearing to center of first full section, LH	\$153.96	
SCP011185	Case-IH, 230, 1190, 4000, 5000, LH	\$220.04	
SCP011259	Case-IH, 990, LH	\$152.02	
SCP011186	Case-IH, 1490, 1590, LH	\$303.76	
SCP015474	Case-IH, 8220, 8330, 8340, 8360, 8370, 8820, 8830, SC414, LH	\$126.48	
SCP015475	Case-IH, 8220, 8330, 8340, 8360, 8370, 8820, 8830, SC414, double drive, RH	\$126.48	
SCP083616	Case-IH, 8380, 8840, 8870, LH	\$206.05	
SCP083617	Case-IH, 8380, 8840, 8870, double drive, RH	\$206.05	

Caterpillar			
Product ID	Description	Price	
SCP016326	Caterpillar, flex head, LH	\$265.27	



Claas			
Product ID	Description	Price	
SCP016326	Claas, 8450, 8460, 20' and more, bearing not included, LH	\$265.27	
SCP015949	Claas, bearing for SCP016326 knifehead	\$186.23	
SCP011125	Claas 642, 8450, 8460, S450, 15' and less, bearing not included, LH	\$189.47	
SCP011127	Claas, bearing for SCP011125 knifehead	\$169.38	
SCP011252	Claas, Hart Carter Series 2 floating cutter bar, LH	\$153.96	





Gehl			
Product ID	Description	Price	
SCP083618	Gehl, 1070, 1090, LH	\$129.69	
SCP011229	Gehl, 2230, 2650, 2850, LH	\$143.87	







SCH Hardware Kits for Knifeheads			
Product ID	Description	Price	
SCP083601	Parts package, for knifeheads with top strap	\$5.53	
SCP083784	Parts package, for knifeheads without top strap	\$5.53	



# SCH EASYCUT II KNIFEHEADS







Hesston			
Product ID	Description	Price	
SCP113668	Hesston, 9300, lap double drive, RH, w/ bearing	\$156.56	
SCP081363	Hesston, 5100, 5200 draper, LH	\$186.48	
SCP014534	Hesston, 500, 520, 1070, 1071, 1085, 1090, 1091, 1095, 1110, 1150, 6450, 6455, 6465, 6550, 6655, 6665, LH	\$118.11	
SCP014535	Hesston, 1014+2, 6450, 6455, 6550, 6655, 6665, double drive, RH	\$118.11	
SCP083616	Hesston, 1170, 1275, 1160, 8400, 8450, 8840, 8870, 9125 LH	\$206.05	
SCP083617	Hesston, 1170, 1275, 8400, 8450, 8840, 8870, 9125, double drive, RH	\$206.05	
SCP011229	Hesston, 320, 420, 1014, 1260, 1265, 6400, 6600, 6610, LH	\$143.87	
SCP011258	Hesston, 600, 1010, PT-7, PT-10, LH	\$124.46	
SCP015474	Hesston, 1120, 1160, 8100, 8200, 8400, LH	\$126.48	
SCP015475	Hesston, 1120, 1160, 8100, 8200, 8400, double drive, RH	\$126.48	

Honey Bee			
Product ID	Description	Price	
SCP014226	Honey Bee, model year 2002-2010, LH	\$188.25	
SCP014227	Honey Bee, model year 2002-2010, double drive, RH	\$188.25	















John Deere			
Product ID	Description	Price	
SCP103187	John Deere 600FD, 700FD hydraflex draper, LH	\$217.89	
SCP103188	John Deere 600FD, 700FD hydraflex draper, double drive, RH	\$217.89	
SCP002557	John Deere 600F Auger Platform, Cast top mount, requires 2 open top guards	\$138.26	
SCP015421	John Deere, 600F Auger Platform, Steel bottom mount with top strap, Requires 1 open top guard	\$198.57	
SCP081352	John Deere, 900 series draper, LH	\$224.07	
SCP011207	John Deere, 200 & 900 series flex & rigid, LH	\$198.57	
SCP011121	John Deere, crank arm style, rigid, bearing not included, LH	\$112.09	
SCP011122	John Deere, bearing for SCP011121 knifehead	\$227.05	
SCP011196	John Deere, 130, 300, 1207, 1209, 1219, 1380, 1424, bushing style (serial #285000-), LH	\$145.69	















John Deere Continued			
Product ID	Description	Price	
SCP011197	John Deere, 300 double drives, bushing style (serial #285000-), double drive, RH	\$145.69	
SCP115427	John Deere, 130, 160, 230, 300, 710, 720, 820, 890, 895, 1207, 1209, 1219, 1380, 1424, 1600, 2280, 2320, 2420, needle bearing style, LH, w/ bearing	\$151.83	
SCP181378	John Deere, 300, 890, 895, 1600 double drives, needle bearing style, double drive, RH, w/ bearing	\$195.00	
SCP011220	John Deere, 78, 220, 230, 485, 710, 800, 830, 880, 1207, 1209, 2250, 2270, ball joint style (serial # -285000), LH	\$198.57	
SCP083663	John Deere, 50, 250, 350, 450, 3700, bearing style, LH	\$129.69	
SCP083662	John Deere, 50, 250, 350, 450, bushing style, LH	\$129.69	
SCP115428	John Deere 2360, LH, w/ bearing	\$151.83	

Lexion			
Product ID	Description	Price	
SCP002413	Lexion, F535, F540, LH	\$357.05	
SCP002412	Lexion, F535, F540, double drive, RH	\$357.05	
SCP016326	Lexion, F30, F530, LH	\$265.27	

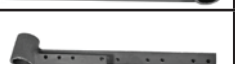

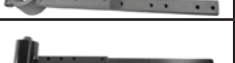
MacDon			
Product ID	Description	Price	
SCP181379	MacDon, D50, D60, D65, FD70, 30' & longer; D130, D135, D140, D145, FD75 FD130, FD135, FD140, FD145, all/ LH, w/ bearing	\$195.00	
SCP181380	MacDon, D50, D60, D65, FD70, 30' & longer; D130, D135, D140, D145, FD75 FD130, FD135, FD140, FD145, all/ RH, w/ bearing	\$195.00	
SCP181373	MacDon, 973, 974, 10 degree, LH, w/ bearing	\$195.00	
SCP181381	MacDon, 973, 974, 10 degree, RH, w/ bearing	\$195.00	
SCP113667	MacDon, 972, all; D50, D60, D65, FD70, 25' & shorter / LH, w/ bearing	\$156.56	
SCP113668	MacDon, 972, all; D50, D60, D65, FD70, 25' & shorter /RH, w/bearing	\$156.56	
SCP115428	MacDon, 910, 920 lap double drive, 942, 960, 973, 7000, LH, w/ bearing	\$151.83	
SCP181351	MacDon, 920 lap double drive, 942 double drive, RH, w/ bearing	\$189.36	
SCP115427	MacDon, 920, LH, w/ bearing	\$151.83	
SCP181378	MacDon, 920, double drive, RH, w/ bearing	\$195.00	
SCP183669	MacDon, 4000, LH, w/ bearing	\$254.89	

# SCH EASYCUT II KNIFEHEADS



Massey-Ferguson			
Product ID	Description	Price	
SCP002584	Massey-Ferguson 8200, 9250, LH	\$168.66	
SCP002585	Massey-Ferguson 9250, RH	\$168.66	
SCP013997	Massey-Ferguson, 7000, 9850, LH	\$161.40	
SCP011255	Massey-Ferguson, 8560, 8920, 9300, 9520, 9750, Rotary, LH	\$172.46	
SCP016326	Massey-Ferguson, 8450, 8460, 20' and more, bearing not included, LH	\$265.27	
SCP015949	Massey-Ferguson, bearing for SCP016326 knifehead	\$186.23	
SCP011125	Massey-Ferguson, 642, 8450, 8460, S450, 15' and less, bearing not included, LH	\$189.47	
SCP011127	Massey-Ferguson, bearing for SCP011125 knifehead	\$169.38	
SCP011211	Massey-Ferguson, Hart Carter & Hiniker floating cutter bar, knifehead bushing at 0-degree angle, LH Note: For replacement only. New kits will reuse the OEM knifehead.	\$209.17	
SCP011212	Massey-Ferguson, Hart Carter & Hiniker floating cutter bar, knifehead bushing at 5-degree angle, LH Note: For replacement only. New kits will reuse the OEM knifehead.	\$209.17	
SCP011263	Massey-Ferguson, 725, 925, LH	\$152.01	
SCP011188	Massey-Ferguson, 655, 675, 775, 785, LH	\$115.23	
SCP115428	Massey-Ferguson, 885, LH, w/ bearing	\$151.83	
SCP081363	Massey-Ferguson, 220 windrower, LH	\$186.48	

New Holland Continued			
Product ID	Description	Price	
SCP011214	New Holland, 73C; 74C S/N all "HAJ" & up to PNL018301; 970, 971, 972, 973, double drive, RH	\$130.18	
SCP181373	New Holland, 84C, 10 degree, LH, w/ bearing	\$195.00	
SCP181381	New Holland, 84C, 10 degree, RH, w/ bearing	\$195.00	
SCP083815	New Holland, 74C S/N PNL018301 and after, double drives, LH	\$154.89	
SCP083816	New Holland, 74C S/N PNL018301 and after, double drive, RH	\$154.89	
SCP014226	New Holland 88C, model year 2002-2010, LH	\$188.25	
SCP014227	New Holland 88C, model year 2002-2010, double drive, RH	\$188.25	
SCP011191	New Holland, 474, 489, 492, 1465, LH	\$189.57	
SCP011192	New Holland, 472, 477, 478, 479, 488, LH	\$231.98	
SCP083678	New Holland, 114 windrower, LH	\$151.60	
SCP083679	New Holland, 114 windrower, double drive, RH	\$151.60	
SCP011276	New Holland, 116, 910, 912, 1100, 1112, 1114, 1116, 1118, LH	\$115.23	
SCP011277	New Holland, 116, 910, 912, 1112, 1114, 1116, 1118, double drive, RH	\$115.23	
SCP011219	New Holland, 461, 467, 469, 490, LH	\$250.59	
SCP011224	New Holland, 495, 1495, LH	\$130.18	
SCP083614	New Holland, 1475, 2216, 2300, 2326, 2450, 2550, H7150, LH	\$206.05	
SCP083615	New Holland, 1475, 2216, 2300, 2326, 2450, 2550, H7150, double drive, RH	\$206.05	

## Owatonna

Product ID	Description	Price	
SCP011280	Owatonna, 200, 206, 217, 235, 260, 265, 270, 275, 285, 7/8-18 threads per inch, LH	\$143.87	
SCP011281	Owatonna, 260, 280, 7/8-14 threads per inch, LH	\$143.87	

## Versatile

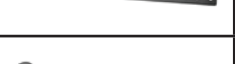
Product ID	Description	Price	
SCP083677	Versatile, 4030, LH	\$129.69	
SCP083680	Versatile, 4030, double drive, RH	\$129.69	
SCP011193	Versatile, 10, 400, 3-1/2" from center of knifehead bearing to center of first full section, LH	\$115.23	
SCP011217	Versatile, 400, 4400, 3" from center of knifehead bearing to center of first full section, LH	\$115.23	

# SCH EASYCUT II KITS

Mfg.	Type	Model Description	Guard	Wear Plate, Spacer	Lefthand Knifehead	Righthand Knifehead	Mfg.	Type	Model Description	Guard	Wear Plate, Spacer	Lefthand Knifehead	Righthand Knifehead
AGCO	Draper	9250	12mm	6mm	SCP002584	SCP002585	Case-IH	Flex	2020, S/N CBJ021301 and after	14mm	6mm	SCP083815	SCP083816
AGCO	Flex	300 Series, Early Style	12mm	6mm	SCP011195		Case-IH	Flex	3020	17mm	6mm	SCP002401	
AGCO	Flex	500, 800, 8000, 300 Series, 3/4" knifehead	12mm	6mm	SCP011222		Case-IH	Rigid	403 Hiniker	12mm	6mm	OEM	
AGCO	Flex	500, 800, 8000, 300 Series, 7/8" knifehead	12mm	6mm	SCP013997		Case-IH	Rigid	1010	14mm	5mm	SCP014266	
AGCO	Flex	7200, 8200	12mm	6mm	SCP002584		Case-IH	Windrower	201	17mm	6mm	OEM	
AGCO	Flex	Hart Carter, Pitman Drive (1pc head)	14mm	5mm	OEM		Case-IH	Windrower	230	14mm	5mm	SCP011185	
AGCO	Flex	Hart Carter, Pitman Drive (2pc head)	14mm	5mm	OEM		Case-IH	Windrower	275	14mm	5mm	OEM	
AGCO	Flex	Hart Carter, Series 2	14mm	5mm	SCP011252		Case-IH	Windrower	375	14mm	5mm	OEM	
AGCO	Rigid	300, 700 Series, Rigid	12mm	6mm	SCP011195		Case-IH	Windrower	721	17mm	5mm	OEM	
AGCO	Windrower	5100, 5200	12mm	6mm	SCP081363		Case-IH	Windrower	725	17mm	5mm	OEM	
Case-IH	Mower	#9, 7/16" BB	17mm	6mm	OEM		Case-IH	Windrower	1275	14mm	5mm	SCP011229	
Case-IH	Mower	#9, 1/2" BB	17mm	5mm	OEM		Case-IH	Windrower	5000, 7/16" BB	17mm	6mm	SCP011185	
Case-IH	Mower	#31	17mm	4mm	OEM		Case-IH	Windrower	5000, 1/2" BB	17mm	5mm	SCP011185	
Case-IH	Mower	1100, 100, 7/16" BB	17mm	6mm	OEM		Case-IH	Windrower	6000	17mm	6mm	SCP015428	
Case-IH	Mower	1100, 100, 1/2" BB	17mm	5mm	OEM		Case-IH	Windrower	8220	14mm	5mm	SCP015474	
Case-IH	Mower	1200	17mm	6mm	OEM		Case-IH	Windrower	8340	14mm	5mm	SCP015474	
Case-IH	Mower	1300	17mm	6mm	OEM		Case-IH	Windrower	8360, 7/16" BB	17mm	6mm	SCP015474	
Case-IH	Mo-Co	990	14mm	5mm	SCP011259		Case-IH	Windrower	8370, 8830, 3/8" BB	14mm	5mm	SCP015474	
Case-IH	Mo-Co	1190	17mm	6mm	SCP011185		Case-IH	Windrower	8370, 8830, 7/16" BB	17mm	6mm	SCP015474	
Case-IH	Mo-Co	1490, 1590	17mm	6mm	SCP011186		Case-IH	Windrower	8380, 8840, 8870, 7/16" BB	17mm	6mm	SCP083616	SCP083617
Case-IH	Mo-Co	8330	17mm	6mm	SCP015474		Case-IH	Windrower	8820	17mm	6mm	SCP015474	SCP015475
Case-IH	Mo-Co	SC414	17mm	6mm	SCP015474		Case-IH	Windrower	HDX162	14mm	5mm	SCP083614	SCP083615
Case-IH	Draper	2042, 2052, 2062 Flex, SCH skid plates required	14mm	5mm	SCP081373		Caterpillar	Flex	Caterpillar, 3/8" BB	14mm	5mm	SCP016326	
Case-IH	Draper	2142, 2152, 2162 Rigid, SCH skid plates required	14mm	5mm	SCP081379	SCP081380	Caterpillar	Flex	Caterpillar, 5/16" BB	12mm	5mm	SCP016326	
Case-IH	Draper	4000	14mm	6mm	SCP011185		Caterpillar	Flex	Caterpillar, 1/2" BB	17mm	5mm	SCP016326	
Case-IH	Flex	503	14mm	5mm	OEM		Claas	Windrower	S450	12mm	6mm	SCP011125	
Case-IH	Flex	810 (4-1/4" center of first section)	14mm	5mm	SCP011252		Ford	Mower	501	17mm	6mm	OEM	
Case-IH	Flex	810 (5" center of first section)	14mm	5mm	SCP011227		Ford	Mower	505	17mm	6mm	OEM	
Case-IH	Flex	810 Hiniker	12mm	6mm	SCP011227		Ford	Mower	515	17mm	6mm	OEM	
Case-IH	Flex	810 Pitman Drive	14mm	5mm	OEM		Ford	Mower	642	12mm	6mm	OEM	
Case-IH	Flex	820	17mm	6mm	SCP011226		Frontier	Mower	1477	17mm	6mm	OEM	
Case-IH	Flex	1020	17mm	5mm	SCP014266		Gehl	Mo-Co	1070	17mm	6mm	SCP083618	
Case-IH	Flex	2020, early style	14mm	5mm	SCP083792	SCP083793	Gehl	Mo-Co	1090	17mm	6mm	SCP083618	
Case-IH	Flex	2020, S/N all "HAJ" & up to CBJ021301	14mm	5mm	SCP011213	SCP011214	Gehl	Mo-Co	1216 Hydra Swing	14mm	5mm	SCP013667	
							Gehl	Mo-Co	2130	12mm	6mm	SCP014534	
							Gehl	Mo-Co	2160, 1/4" BB	12mm	6mm	SCP014534	
							Gehl	Mo-Co	2160, 7/16" BB	17mm	6mm	SCP014534	
							Gehl	Mo-Co	2170	12mm	6mm	SCP011280	
							Gehl	Mo-Co	2270	12mm	6mm	SCP011280	
							Gehl	Mo-Co	2650	12mm	6mm	SCP011229	

The SCH EasyCut II Kits pages are a list of the most common machines that can be converted to the SCH EasyCut II cutter bar system. This may also be helpful in determining which parts to order for certain machines.

If your machine is not listed, this does not mean that we do not fit that machine. Please call for assistance.

# SCH EASYCUT II KITS

Mfg.	Type	Model Description	Guard	Wear Plate, Spacer	Lefthand Knifehead	Righthand Knifehead	Mfg.	Type	Model Description	Guard	Wear Plate, Spacer	Lefthand Knifehead	Righthand Knifehead
Gehl	Mo-Co	2850	12mm	6mm	SCP011229		Hesston	Windrower	9300	14mm	5mm	SCP013667	SCP013668
Gehl	Mo-Co	HK108	12mm	6mm	OEM		Honey Bee	Draper	Draper	12mm	6mm	SCP014226	
Gehl	Windrower	2230	17mm	5mm	SCP011229		Honey Bee	Draper	Draper, 8mm wear plates	12mm	8mm	SCP014226	
Gehl	Windrower	2240	12mm	6mm	SCP011280		Honey Bee	Flex	3/16" BB, 8mm wear plates	12mm	8mm	SCP014226	SCP014227
Hesston	Mo-Co	1010	12mm	6mm	SCP011258		Honey Bee	Flex	1/4" BB	12mm	6mm	SCP014226	SCP014227
Hesston	Mo-Co	1070, 1071, 3/8" BB	14mm	5mm	SCP014534		Honey Bee	Flex	Series 3	12mm	6mm	OEM	
Hesston	Mo-Co	1070, 1071, 1/2" BB	17mm	5mm	SCP014534		John Deere	Mower	#5, 3/8" BB	14mm	5mm	OEM	
Hesston	Mo-Co	1085, 1090, 1091, 1095	14mm	5mm	SCP014534		John Deere	Mower	#5, 7/16" BB	17mm	6mm	OEM	
Hesston	Mo-Co	1110	17mm	5mm	SCP014534		John Deere	Mower	#8, #38, #39	14mm	5mm	OEM	
Hesston	Mo-Co	1120	17mm	6mm	SCP015474		John Deere	Mower	#8W	14mm	5mm	OEM	
Hesston	Mo-Co	1150	14mm	5mm	SCP014534		John Deere	Mower	#9	17mm	5mm	OEM	
Hesston	Mo-Co	1160, 8200, 1/4" BB	12mm	6mm	SCP015474		John Deere	Mower	#10	17mm	6mm	OEM	
Hesston	Mo-Co	1160, 8200, 7/16" BB	17mm	6mm	SCP015474		John Deere	Mower	#11	14mm	5mm	OEM	
Hesston	Mo-Co	1170	14mm	5mm	SCP083616	SCP083617	John Deere	Mower	#37	17mm	6mm	OEM	
Hesston	Mo-Co	1260, 7/16" BB	17mm	6mm	SCP011229		John Deere	Mower	50 (Bushing Knifehead)	17mm	6mm	SCP083662	
Hesston	Mo-Co	1265 Hydra Swing	17mm	6mm	SCP011229		John Deere	Mower	250, 350, 450, 3700 (Bearing Knifehead)	14mm	4mm	SCP083663	
Hesston	Mo-Co	1275	17mm	6mm	SCP083616	SCP083617	John Deere	Mower	250, 350, 450 (Bushing Knifehead)	14mm	4mm	SCP083662	
Hesston	Mo-Co	1660, 1/4" BB	12mm	6mm	SCP083616		John Deere	Mo-Co	485 (Ball Joint Knifehead)	14mm	5mm	SCP011220	
Hesston	Mo-Co	PT 10	14mm	5mm	SCP011258		John Deere	Mo-Co	710	17mm	5mm	SCP011220	
Hesston	Windrower	320	17mm	6mm	SCP011229		John Deere	Mo-Co	720 (Ball Joint Knifehead)	17mm	5mm	SCP011220	
Hesston	Windrower	420	17mm	6mm	SCP011229		John Deere	Mo-Co	720, 820, 7/16" BB	17mm	6mm	SCP015427	
Hesston	Windrower	500, 1/2" BB	17mm	5mm	SCP014534		John Deere	Mo-Co	720, 820, 1/2" BB	17mm	5mm	SCP015427	
Hesston	Windrower	520, 7/16" BB	17mm	6mm	SCP014534		John Deere	Mo-Co	820, 1/2" BB (Ball Joint Knifehead)	17mm	5mm	SCP011220	
Hesston	Windrower	600	14mm	5mm	SCP011258		John Deere	Mo-Co	1207, 1209, 1219 (Ball Joint Knifehead)	14mm	5mm	SCP011220	
Hesston	Windrower	1014 Hydra Swing	14mm	5mm	SCP011229		John Deere	Mo-Co	1207, 1209, 1219 (Bearing Knifehead)	14mm	5mm	SCP015427	
Hesston	Windrower	2262, 1/2" BB	17mm	5mm	SCP014534	SCP014535	John Deere	Mo-Co	1207, 1209, 1219 (Bushing Knifehead)	14mm	5mm	SCP011196	
Hesston	Windrower	5100, 5200	12mm	6mm	SCP081363		John Deere	Mo-Co	1380, 1424 (K10)	14mm	5mm	SCP011196	
Hesston	Windrower	6400, 6600, 5/16" BB	12mm	5mm	SCP011229		John Deere	Mo-Co	1380, 1424 (K42)	14mm	5mm	SCP015427	
Hesston	Windrower	6400, 6600, 3/8" BB	14mm	5mm	SCP011229		John Deere	Mo-Co	1600 (Bearing Knifehead)	14mm	5mm	SCP015427	SCP081378
Hesston	Windrower	6400, 6600, 7/16" BB	17mm	5mm	SCP011229		John Deere	Draper	78	14mm	5mm	SCP011220	
Hesston	Windrower	6450, 6465	17mm	6mm	SCP014534	SCP014535	John Deere	Draper	160	14mm	5mm	SCP015427	
Hesston	Windrower	6455	14mm	5mm	SCP014534	SCP014535	John Deere	Draper	130, 3/8" BB	14mm	5mm	SCP011196	
Hesston	Windrower	6550	17mm	5mm	SCP014534	SCP014535	John Deere	Draper	130, 7/16" BB	17mm	6mm	SCP011196	
Hesston	Windrower	6600, 6610, 3/8" BB	14mm	5mm	SCP011229		John Deere	Auger	220, 230 (Ball Joint Knifehead)	14mm	5mm	SCP011220	
Hesston	Windrower	6600, 7/16" BB	17mm	6mm	SCP011229		John Deere	Auger	230, 240 (Needle Bearing)	14mm	5mm	SCP015427	
Hesston	Windrower	6655, 6665	14mm	5mm	SCP014534	SCP014535							
Hesston	Windrower	8100	17mm	5mm	SCP015474	SCP015475							
Hesston	Windrower	8400, 9125, 3/8" BB	14mm	5mm	SCP083616	SCP083617							
Hesston	Windrower	8400, 9125, 7/16" BB	17mm	6mm	SCP083616	SCP083617							
Hesston	Windrower	8450, 3/8" BB	14mm	5mm	SCP083616	SCP083617							
Hesston	Windrower	8450, 8840, 8870, 7/16" BB	17mm	6mm	SCP083616								

If your machine is not listed, this does not mean that we do not fit that machine. Please call for assistance.

# SCH EASYCUT II KITS

Mfg.	Type	Model Description	Guard	Wear Plate, Spacer	Lefthand Knifehead	Righthand Knifehead	Mfg.	Type	Model Description	Guard	Wear Plate, Spacer	Lefthand Knifehead	Righthand Knifehead
John Deere	Draper	930, 936	12mm	6mm	SCP081352		M/F	Draper	885	14mm	5mm	SCP015428	
John Deere	Flex	200 Series	12mm	6mm	SCP011207		M/F	Draper	9250	12mm	6mm	SCP002584	SCP002585
John Deere	Flex	600F Series HydraFlex	12mm	6mm	SCP015421		M/F	Flex	1859, 9100 Series; Hart Carter	14mm	5mm	OEM	
John Deere	Draper	600FD, 700FD HydraFlex Draper	12mm	5mm	SCP0103187	SCP103188	M/F	Flex	7200, 8200	12mm	6mm	OEM	
John Deere	Flex	900 Series	12mm	6mm	SCP011207		M/F	Flex	9224 Rotary	12mm	6mm	SCP011255	
John Deere	Flex	Hart Carter, Pitman Drive	14mm	5mm	OEM		M/F	Flex	9850 (AGCO Manufactured)	12mm	6mm	SCP013997	
John Deere	Rigid	55	12mm	6mm	SCP011207		M/F	Windrower	35	12mm	4mm	OEM	
John Deere	Rigid	55, Hart Carter, Pitman Drive	14mm	5mm	OEM		M/F	Windrower	200	12mm	6mm	OEM	
John Deere	Rigid	200 Series	12mm	6mm	SCP011207		M/F	Windrower	775	12mm	5mm	SCP011220	
John Deere	Rigid	900 Series	12mm	6mm	SCP011207		M/F	Windrower	785	12mm	5mm	SCP011188	
John Deere	Windrower	300 (Bushing Knifehead)	14mm	5mm	SCP011196	SCP011197	M/F	Windrower	3850	12mm	6mm	SCP011222	
John Deere	Windrower	300, 1380, 1424 (Bearing Knifehead)	14mm	5mm	SCP015427	SCP081378	M/F-Claas	Windrower	36, 44	12mm	6mm	OEM	
John Deere	Windrower	580, 1/4" BB	12mm	6mm	OEM		M/F-Claas	Flex	8450, 8460	12mm	6mm	SCP011125	
John Deere	Windrower	580, 5/16" BB	12mm	4mm	OEM		M/F-White	Flex	8560, 9520, 1/4" BB	12mm	6mm	SCP011255	
John Deere	Windrower	590, 3/8" BB	14mm	5mm	OEM		M/F-White	Flex	8560, 8920, 9300, 9330, 9520, 9750, 3/8" BB	14mm	5mm	SCP011255	
John Deere	Windrower	800, 2250, 2270, 3/8" BB	14mm	5mm	SCP011220		M/F-Claas	Rigid	8460	12mm	6mm	SCP011125	
John Deere	Windrower	800, 7/16" BB	17mm	6mm	SCP011220		MacDon	Mo-Co	4000	14mm	5mm	SCP083669	
John Deere	Windrower	800, 1/2" BB	17mm	5mm	SCP011220		MacDon	Mo-Co	A30-S	17mm	6mm	SCP081379	
John Deere	Windrower	830	14mm	5mm	SCP011220		MacDon	Auger	920	14mm	5mm	SCP015428	SCP081351
John Deere	Windrower	880	14mm	5mm	SCP011220		MacDon	Draper	942	14mm	5mm	SCP015428	SCP081351
John Deere	Windrower	890	17mm	5mm	SCP015427		MacDon	Draper	972	14mm	5mm	SCP013667	SCP013668
John Deere	Windrower	2250	14mm	5mm	SCP011220		MacDon	Draper	974 Flex, SCH skid plates required	14mm	5mm	SCP081373	
John Deere	Windrower	2270	14mm	5mm	SCP011220		MacDon	Draper	FD70 Flex, SCH skid plates required	14mm	5mm	SCP081379	SCP081380
John Deere	Windrower	2280	14mm	5mm	SCP011196		MacDon	Draper	FD75 Flex, SCH skid plates required	14mm	5mm	SCP081379	SCP081380
John Deere	Windrower	2320, 2420	14mm	5mm	SCP015427		MacDon	Draper	D60 Rigid, SCH skid plates required	14mm	5mm	SCP081379	SCP081380
John Deere	Windrower	2360	14mm	5mm	SCP015428		MacDon	Flex	973, SCH skid plates required	14mm	5mm	SCP015428	
Kosch	Mower	4840	17mm	6mm	OEM		MacDon	Windrower	910	14mm	5mm	SCP015428	
Lexion	Flex	F30, F530	12mm	6mm	SCP016326		MacDon	Windrower	920	14mm	5mm	SCP015428	SCP081351
Lexion	Flex	F535, F540; 8mm plates	12mm	4mm	SCP002413	SCP002412	MacDon	Windrower	960	14mm	5mm	SCP015428	
Love	Flex	Love Bar	14mm	5mm	OEM		MacDon	Windrower	3000	14mm	5mm	OEM	
M/F	Mower	#41	17mm	6mm	OEM		MacDon	Windrower	5000, 5020	14mm	5mm	SCP013667	
M/F	Mower	#42	17mm	5mm	OEM		MacDon	Windrower	5010	17mm	5mm	SCP013667	
M/F	Mower	410	14mm	5mm	OEM		MacDon	Windrower	7000	14mm	5mm	SCP015428	
M/F	Mo-Co	81	17mm	6mm	OEM		Mccormick	Mower	Mower, 7/16" BB	17mm	6mm	OEM	
M/F	Mo-Co	725	14mm	5mm	SCP011263		New Holland	Mower	405	17mm	5mm	OEM	
M/F	Mo-Co	925	14mm	5mm	SCP011263		New Holland	Mower	450, 455, 1/4" BB	12mm	6mm	OEM	
M/F	Auger	1880	14mm	5mm	OEM		New Holland	Mower	450, 455, 3/8" BB	14mm	6mm	OEM	
M/F	Draper	220	12mm	6mm	OEM								
M/F	Draper	655, 675, 775, 785	12mm	4mm	SCP011188								

The SCH EasyCut II Kits pages are a list of the most common machines that can be converted to the SCH EasyCut II cutter bar system. This may also be helpful in determining which parts to order for certain machines.

# SCH EASYCUT II KITS

Mfg.	Type	Model Description	Guard	Wear Plate, Spacer	Lefthand Knifehead	Righthand Knifehead	Mfg.	Type	Model Description	Guard	Wear Plate, Spacer	Lefthand Knifehead	Righthand Knifehead
New Holland	Mower	450, 455, 7/16" BB	17mm	6mm	OEM		New Idea	Mower	251, 254	17mm	6mm	OEM	
New Holland	Mower	451, 456, 1/4" BB	12mm	6mm	OEM		New Idea	Mower	252	14mm	5mm	OEM	
New Holland	Mower	451, 456, 3/8" BB	14mm	5mm	OEM		New Idea	Mower	522, 3/8" BB	14mm	5mm	OEM	
New Holland	Mower	451, 456, 7/16" BB	17mm	6mm	OEM		New Idea	Mower	522, 7/16" BB	17mm	6mm	OEM	
New Holland	Mower	451, 456, 1/2" BB	17mm	5mm	OEM		New Idea	Mower	522, 1/2" BB	17mm	5mm	OEM	
New Holland	Mo-Co	467	17mm	6mm	SCP011219		New Idea	Mo-Co	290	17mm	6mm	OEM	
New Holland	Mo-Co	461, 469, 7/16" BB	17mm	6mm	SCP011219		New Idea	Mo-Co	299	14mm	5mm	OEM	
New Holland	Mo-Co	472, 477, 478	17mm	6mm	SCP011192		New Idea	Mo-Co	509	14mm	5mm	SCP011186	
New Holland	Mo-Co	474, 3/8" BB	14mm	5mm	SCP011191		New Idea	Mo-Co	5107	17mm	6mm	OEM	
New Holland	Mo-Co	488, 479	17mm	6mm	SCP011192		New Idea	Mo-Co	5109	17mm	6mm	OEM	
New Holland	Mo-Co	489, 3/8" BB	14mm	5mm	SCP011191		New Idea	Mo-Co	5112	14mm	5mm	SCP011186	
New Holland	Mo-Co	489, 7/16" BB	17mm	6mm	SCP011191		New Idea	Mo-Co	5114	14mm	5mm	SCP011186	
New Holland	Mo-Co	490	17mm	6mm	SCP011219		New Idea	Flex	711	17mm	6mm	SCP011282	
New Holland	Mo-Co	492, 3/8" BB	14mm	5mm	SCP011191		New Idea	Flex	713, 813 Uni Harvester	12mm	6mm	OEM	
New Holland	Mo-Co	492, 7/16" BB	17mm	6mm	SCP011191		New Idea	Flex	715 Uni Harvester	12mm	6mm	OEM	
New Holland	Mo-Co	495, 1495	17mm	6mm	SCP011224		New Idea	Flex	7165	12mm	6mm	SCP011282	
New Holland	Mo-Co	880	14mm	5mm	OEM		New Idea	Flex	815	12mm	6mm	SCP011282	
New Holland	Mo-Co	1496	14mm	5mm	OEM	OEM	Oliver	Mower	82	17mm	5mm	OEM	
New Holland	Mo-Co	H7150	12mm	5mm	SCP083614	SCP083615	Oliver	Flex	525	14mm	5mm	OEM	
New Holland	Flex	73C	14mm	5mm	SCP011213	SCP011214	Oliver	Flex	7600	14mm	5mm	OEM	
New Holland	Flex	74C, S/N all HAJ & up to PNL018301	14mm	5mm	SCP011213	SCP011214	Owatonna	Mower	20, Pitman Drive	12mm	6mm	OEM	
New Holland	Flex	74C, S/N PNL018301 and after	14mm	6mm	SCP083815	SCP083816	Owatonna	Mo-Co	200	12mm	6mm	SCP011280	
New Holland	Flex	740CF	17mm	6mm	SCP002401		Owatonna	Windrower	235	12mm	6mm	SCP011280	
New Holland	Draper	84C Flex	14mm	5mm	SCP081373		Owatonna	Windrower	260, 270, 280	12mm	6mm	SCP011280	
New Holland	Draper	88C Flex, 1/4" BB	12mm	6mm	SCP014226	SCO014227	Owatonna	Windrower	265, 275, 285	12mm	6mm	SCP011280	
New Holland	Flex	94C, 8mm Plates	12mm	8mm	SCP014226		Owatonna	Windrower	280	14mm	5mm	SCP015428	
New Holland	Flex	972	14mm	5mm	SCP011213	SCP011214	Owatonna	Windrower	280, 7/8"-18 Threaded Knifehead	12mm	6mm	SCP011281	
New Holland	Flex	973	14mm	5mm	SCP011213		Renn	Windrower	2000	12mm	6mm	SCP011220	
New Holland	Flex	9750 Rotary	14mm	5mm	SCP011255		Rowse	Mower	3/8" BB	14mm	5mm	OEM	
New Holland	Rigid	971	12mm	6mm	SCP011213		Rowse	Mower	7/16" BB	17mm	6mm	OEM	
New Holland	Windrower	114	14mm	5mm	SCP083678	SCP083679	Sickle Bar Mower	Mower	1/4" BB	12mm	6mm	OEM	
New Holland	Windrower	116, 1116	14mm	5mm	SCP011276	SCP011277	Sickle Bar Mower	Mower	5/16" BB	12mm	4mm	OEM	
New Holland	Windrower	499, 1469, 1499	14mm	5mm	OEM	OEM	Sickle Bar Mower	Mower	3/8" BB	14mm	5mm	OEM	
New Holland	Windrower	905	14mm	5mm	OEM		Sickle Bar Mower	Mower	7/16" BB	17mm	6mm	OEM	
New Holland	Windrower	910, 3/8" BB	14mm	5mm	SCP011276	SCP011277	Sickle Bar Mower	Mower	1/2" BB	17mm	5mm	OEM	
New Holland	Windrower	910, 7/16" BB	17mm	6mm	SCP011276		Sickle Bar Mower	Mower	17/32" BB	17mm	4mm	OEM	
New Holland	Windrower	912	14mm	5mm	SCP011276	SCP011277	Versatile	Windrower	#10	12mm	6mm	SCP011193	
New Holland	Windrower	1100	14mm	5mm	SCP011276		Versatile	Windrower	400, 3" C.O.F.S.	12mm	6mm	SCP011217	
New Holland	Windrower	1112	14mm	5mm	SCP011276	SCP011277	Versatile	Windrower	400, 3/1/2" C.O.F.S.	12mm	6mm	SCP011193	
New Holland	Windrower	1114	14mm	5mm	SCP011276	SCP011277	Versatile	Windrower	2800, 4018, 4020, 4022, 4025, 4750	12mm	6mm	OEM	OEM
New Holland	Windrower	1118	14mm	5mm	SCP011276	SCP011277	Versatile	Windrower	4030	12mm	6mm	SCP083677	SCP083680
New Holland	Windrower	1465, 3/8" BB	14mm	5mm	SCP011191		Versatile	Windrower	4400	12mm	6mm	SCP011217	
New Holland	Windrower	1475, 3/8" BB	14mm	5mm	SCP083614		Vicon	Windrower	722	12mm	6mm	SCP011188	
New Holland	Windrower	1475, 2450, 2550, 2300	14mm	5mm	SCP083614	SCP083615	White	Flex	Kwik Cut	14mm	5mm	OEM	
New Holland	Windrower	2216	14mm	5mm	SCP083614	SCP083615	White	Windrower	6200	12mm	6mm	SCP011188	
New Holland	Windrower	2326	14mm	5mm	SCP083614	SCP083615							
New Idea	Mower	#40	17mm	6mm	OEM								

# AS SERIES CROP LIFTERS

**Optimum performance in difficult conditions and lodged crops**



- Helps lift and feed down crops
- Crop lifters are essential in the harvest of different crops such as down wheat, oats, milo and other common cereal grains.
- Spring steel
- Secure and quick attachment
- Closed slimProfile to prevent reel tine interference
- **For use on rigid headers and locked flex headers**



Improved concave sliding skid allows for better sliding dynamics.

SCH AS Series Crop Lifters		
Product ID	Description	Price
SCP416445	SCH ASK-100 croplifter w/spool, guards that are 5.7 - 6.0" long; SCH Easy- Cut I & II; will not work with EC II short guards	\$39.95
SCP116588	SCH ASK-121 croplifter w/spool; guards that are 5.75 - 6.125" long	\$39.95
SCP016587	SCH ASK-120 croplifter w/spool; guards that are 6.1 - 6.4" long	\$39.95
SCP116589	SCH ASK-127 croplifter w/spool; guards that are 6.5 - 6.7" long	\$39.95
SCP010142	SCH AS-100/2 croplifter w/spool; JD 600 series rigid & draper, 900 series draper with 4" OEM long guards; H213405, H229539	\$39.95
SCP213549	SCH AS-100/5 croplifter w/spool; guards that are 5.4 - 5.8" long; JD 200, 900 series auger platforms with OEM guards, H113571, H145791, H153719, H171031	\$39.95
SCP416440	SCH ASO Croplifter; John Deere short-long-short & long-short-long guards; SCH Easy Cut II short guards with hardware pack	\$39.95

**Note:** Croplifters for other guards not listed above may be available.  
Call with measurement from tip of guard point to the center of the guard bolt hole for correct fit.

## PRO FLEX LIFTERS

**High quality lifter finger ensures longer life and reduced distortion**

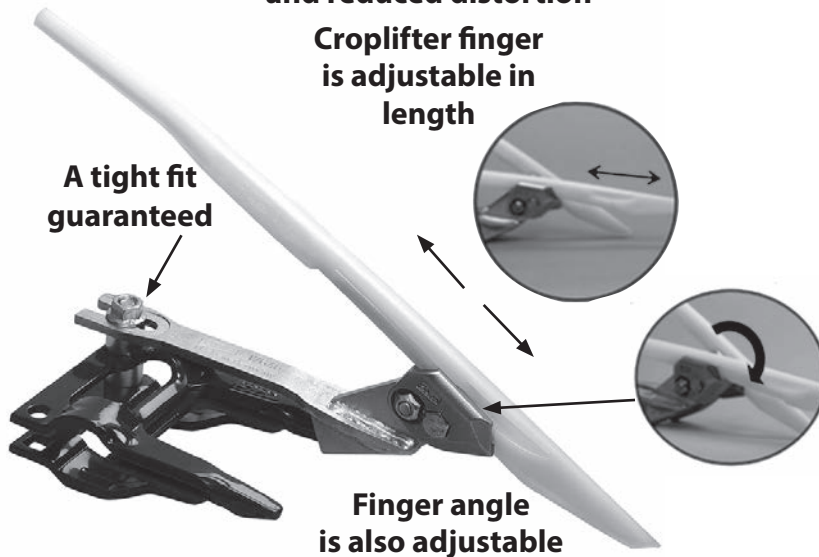

A tight fit guaranteed

Croplifter finger is adjustable in length

Finger angle is also adjustable

**The white color of the lifter finger provides maximum visibility in all crop conditions.**

When ordering please specify the make and model of your head. Also, specify the type of guards that are on the head.

### SCH Pro Flex Lifter Complete Kit

Product ID	Description	Price
SCP399400	Pro Flex Lifter with hardware	\$69.95

### Farmer Testimonial

**Mike Johnson,**

In Canada grows 1,000 + acres of various types of edible beans.

"In comparison to other lifters, the PRO FLEX lifter is much stronger and experienced longer wear along with less breakage on the finger. The simple adjustment, combined with the easy removal and mounting, reduces any unnecessary downtime. The white color of the PRO FLEX finger was much easier to see in the crop."

### SCH Pro Flex Lifter Replacement Finger

Product ID	Description	Price
SCP017937	Replacement Finger	\$13.24

# SCH PRO-DRIVE KNIFE DRIVES

**PROBLEM:** Most knife drives lose stroke length and force.

**SOLUTION:** The SCH Pro Drive's planetary gear system is in rotation at all times. This produces a 100% linear knife movement, compared with wobble boxes or other oscillating and pendulum drives.

The design of the PRO-DRIVE ensures a 100% linear knife movement:

- Less wear on all components
- Less vibrations
- Low power demand

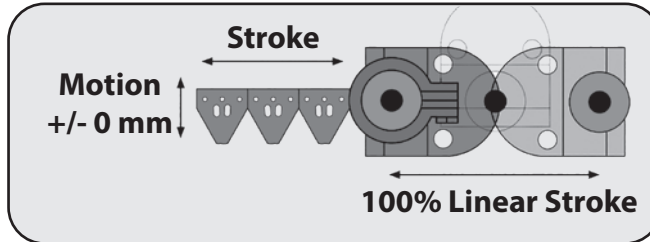

SCH Vertical Belt Driven Pro-Drive



- **Higher Cutting Speed**
- **High Output Forces Using Lower Torque**
- **Low Maintenance** Uses grease lubrication instead of conventional oil bath

## Higher Ground-Travel Cutting Speeds

Testimonial from Huron County, Michigan:

*"I bought a SCH ProDrive knife for my 1020 header this spring. Put 500 acres on it and couldn't be happier! Ground speed was faster by .5 mph to 1 mph, even with worn-out dull guards. I can't wait to see what it will do with brand new knives and guards next fall."*



### All SCH Pro-Drive Conversion Kits Include:

- SCH Pro-Drive, vertical, 85mm (3.3") stroke
- Drive pulley for SCH Pro-Drive
- Mounting bracket(s) for SCH Pro-Drive
- Knifehead
- Extra nylon ring for knifehead



**Warranty:** SCH Pro-Drives have a 1 year warranty on parts and labor from date in service.

### Makes Changing Knives, Even in the Field, a Breeze

The SCH engineers have devised a brilliant method of attaching the knifehead to the drive that is a major advancement. Designed as a trapezoidal claw, the connection is easy and accurate. No bolts to line up, no bearings to adjust or shim, no fear that dirt might get into bearings, bushings, etc. **Makes changing knives even in the field a breeze.**

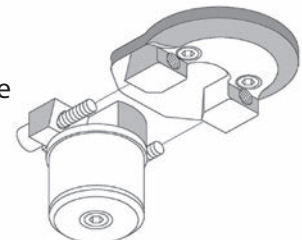

# SCH PRO-DRIVE KITS

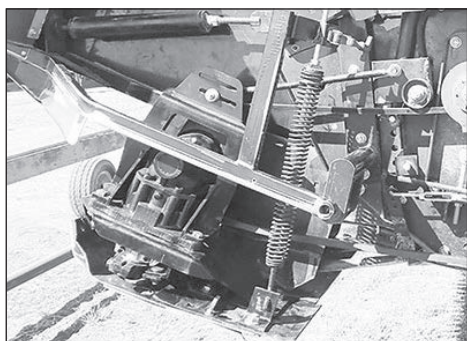

## AGCO SERIES FLEX HEADERS

AGCO 300, 500, 800, 8000 Series Flex Headers			
Description	With SCH Cutter Bar	With AGCO Cutter Bar	Price
300, 500, 800, 8000 Series Headers	SCK100150	SCK100155	\$2,650.00

**Note:** Please specify the tie rod bolt size (3/4" or 7/8") with AGCO cutter bar.

## CASE-IH 1010 RIGID & 1020 FLEX HEADERS

Case-IH 1020 Flex Headers			
Description	With SCH Cutter Bar	With CIH Cutter Bar	Price
Greaseable wobble box, S/N JJC0215000 and lower	SCK100130	SCK100140	\$2,995.00
Oil bath wobble box, S/N JJC0215001 - JJC0323604	SCK100131	SCK100141	\$2,995.00
Oil bath wobble box, S/N JJC0323605 and up; CBJ023001 & up	SCK100132	SCK100142	\$2,995.00

  

Case-IH 1010 Rigid Header			
Description	With SCH Cutter Bar	With CIH Cutter Bar	Price
Rigid, 1010	SCK100133	SCK100143	\$2,600.00



Shown with runner

## JOHN DEERE 200, 900 SERIES FLEX & RIGID HEADERS

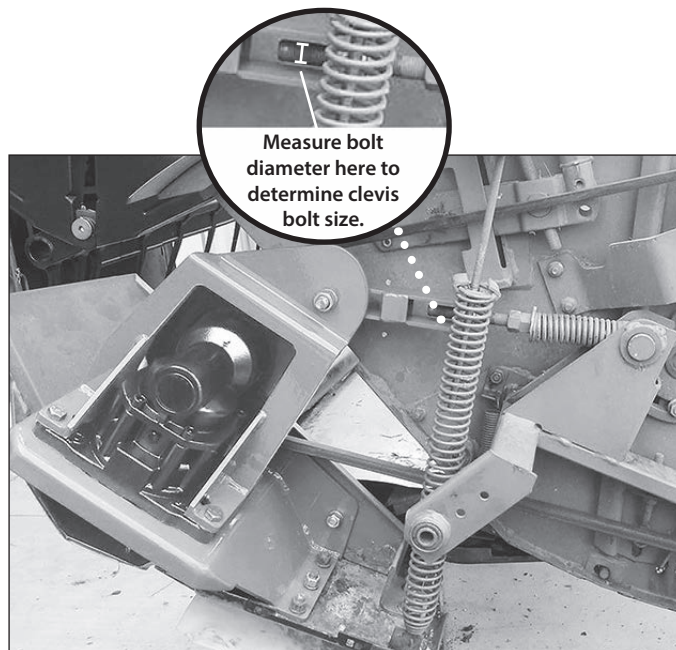

John Deere 200, 900 Series Flex Headers				
Description	Clevis Bolt Size*	With SCH Cutter Bar	With JD Cutter Bar	Price
4420, 6620 & 7720 Combines through 1985; All 9000 Series Combines	1/2"	SCK100100	SCK100110	\$2,650.00
	12mm	SCK100102	SCK100112	\$2,650.00
	16mm	SCK100104	SCK100114	\$2,650.00
6620 & 7720 Combines after 1985; All 8820 Combines	1/2"	SCK100101	SCK100111	\$2,650.00
	12mm	SCK100103	SCK100113	\$2,650.00
	16mm	SCK100105	SCK100115	\$2,650.00

**Note:** \*The clevis bolt size refers to the size of the bolt used on the flex knife drive horizontal stabilizer spring.

John Deere 200, 900 Series Rigid Headers			
Description	With SCH Cutter Bar	With JD Cutter Bar	Price
4420, 6620 & 7720 Combines through 1985; All 9000 Series Combines	SCK100106	SCK100116	\$2,650.00
6620 & 7720 Combines after 1985; All 8820 Combines	SCK100107	SCK100117	\$2,650.00

## MASSEY-WHITE 9750 FLEX HEADERS

Massey-White 9750 Flex Headers			
Description	With SCH Cutter Bar	With M/F Cutter Bar	Price
9750 Headers	SCK100160	SCK100162	\$2,650.00

**Note:** Knifehead for Massey-White cutting system is not available. A knifehead clamp is provided that must be welded to original knifehead strap.

# SCH PRO-DRIVE KITS PARTS

## SCH Vertical Belt Driven Pro-Drive

Description	Product ID	Price
SCH Pro-Drive 85V, vertical, 85mm (3.3") stroke; Replaces drive on SI Distributing's aftermarket Pro-Drive Kits; AGCO 300-8000; CIH 1010, 1020; JD 200-900; MF-White 9750 Note: Does not include pulley; Includes SCP012766 bearing block assembly.	SCP014869	\$1,940.00
SCH Pro-Drive 89V, vertical, 89mm (3.5") stroke Replaces John Deere #DE19785 on 620F, 622F, 625F, 630F, 635F flex platforms & 622R, 625R, 630R rigid platforms. Note: Does not include pulley; Includes SCP014230 bearing block assembly.	SCP014714	\$2,110.00
SCH Pro-Drive 89V, vertical, 89mm (3.5") stroke Replaces John Deere #DE19786 on 925D, 930D, 936D draper platforms. Note: Does not include pulley; Includes SCP014230 bearing block assembly.	SCP014697	\$1,895.00
SCH Pro-Drive 85V, vertical, 85mm (3.3") stroke Replaces drive on AGCO & Massey Ferguson 7200, 8200. Note: Does not include pulley; Includes SCP014230 bearing block assembly.	SCP014811	\$2,245.00



**Vertical Pro-Drive**

## SCH Pro-Drive Bearing Blocks and Bearing Block Replacement Parts

Description	Product ID	Price
Bearing block assembly 17mm, greaseable bearing; Includes: nylon ring & 10mm allen head bolts; SCH Pro-Drive 85V, 85H, 130V, 130H	SCP012766	\$157.77
Bearing block assembly 17mm, sealed bearing; Includes: nylon ring & 10mm allen head bolts; SCH Pro-Drive 85V, 85H, 130V, 130H	SCP014739	\$157.77
Bearing block assembly 27mm, greaseable bearing; Includes: nylon ring & 12mm hex head bolts; AGCO/MF 7200, 8200, 9250 (#71416424), Claas Maxi Flex, JD 600F, 600R, 600D, 600FD, 700FD, 925D, 930D, 936D	SCP014230	\$212.48
Bearing block assembly 27mm, sealed bearing; Includes: nylon ring & 12mm hex head bolts; AGCO/MF 7200, 8200, 9250 (#71416424), Claas Maxi Flex, JD 600F, 600R, 600D, 600FD, 700FD, 925D, 930D, 936D,	SCP014742	\$212.48
Bolt, 10mm x 35mm allen head	SCP010099	\$0.54
Bolt, 12mm x 45mm hex head	SCP010114	\$3.08
Bearing, for greaseable bearing block	SCP010258	\$119.71
Nylon ring, for Pro-Drive knifehead	SCP012543	\$10.09



**Bearing Block Assembly #SCP012766**

## SCH Knifeheads for Pro-Drive With SCH Cutter Bar

Description	Product ID	Price
AGCO flex and rigid knifehead	SCP011341	\$188.31
Case-IH flex and rigid knifehead	SCP011340	\$188.31
John Deere 200, 900 series knifehead	SCP011339	\$188.31
Massey-Ferguson/Hart Carter knifehead	SCP011329	\$188.31
Massey-White 9750 knifehead	SCP083748	\$188.31



#SCP083748



#SCP011339



#SCP011340



#SCP081359

## SCH Knifeheads for Pro-Drive With OEM Cutter Bar

Description	Product ID	Price
AGCO 300-800 series, 3/4" Clamp	SCP081353	\$85.96
AGCO 300-800 series, 7/8" Clamp,	SCP081354	\$85.96
Claas Knifehead	SCP083629	\$224.20
Case-IH 3" system Knifehead	SCP081355	\$228.50
John Deere 200, 900 series knifehead	SCP081359	\$224.06
Weld-on Clamp for Custom Knifehead	SCP011236	\$49.55

## SCH Pulleys for Vertical Pro-Drive

Description	Product ID	Price
Pulley, 6-bolt, 180mm	SCP012775	\$153.50
Pulley, 6-bolt, 190mm	SCP083744	\$153.50
Pulley, 6-bolt, 200mm	SCP012780	\$153.50
Pulley, 6-bolt, 210mm	SCP012782	\$153.50
Pulley, 6-bolt, 220mm	SCP012785	\$153.50
Pulley, 6-bolt, 230mm	SCP012788	\$153.50
Pulley, 6-bolt, 240mm	SCP012802	\$153.50
Hub, required if replacing keyed pulley w/ 6-bolt pulley	SCP012579	\$57.60



**Pulley**



**Mounting Bracket #SCP083817**

## SCH Pro-Drive Mounts and Other Components

Description	Product ID	Price
AGCO Flex Mounting Bracket	SCP082715	\$303.76
AGCO U-bracket, for flex mount	SCP082705	\$167.94
John Deere Flex mounting bracket	SCP083817	\$341.22
John Deere U-bracket, for flex mount	SCP082702	\$167.94
John Deere late 900 series Clevis, 16mm	SCP083626	\$39.61
John Deere for early 900 series Clevis, 12mm	SCP083627	\$39.61
John Deere 200 series Clevis, 1/2"	SCP083628	\$39.61
Mounting plate, used to manufacture custom bracket	SCP083625	\$91.60

# HORIZONTAL PRO-DRIVES



SCH Horizontal Hydraulic Motor Driven Pro-Drive		
Description	Product ID	Price
SCH Pro-Drive 85H, horizontal, 85mm (3.3") stroke; Replaces Honey Bee #27884; Note: Does not include motor adaptor; Includes flywheel & SCP012766 bearing block assembly.	SCP012466	\$1,525.00
SCH Pro-Drive 85H, horizontal, 85mm (3.3") stroke; Replaces Honey Bee #27884; Note: Includes flywheel, 1" motor adaptor & SCP012766 bearing block assembly	SCP002430	\$1,650.00
SCH Pro-Drive 85H, horizontal, 85mm (3.3") stroke; Replaces Honey Bee #27884; Note: Includes flywheel, 1-1/4" motor adaptor & SCP012766 bearing block assembly	SCP015744	\$1,650.00

**Warranty: SCH Pro-Drives have a 1 year warranty on parts and labor from date in service.**

## SCH Pro-Drive Bearing Blocks and Bearing Block Replacement Parts

Description	Product ID	Price
Bearing block assembly 17mm, greaseable bearing; Includes: nylon ring & 10mm allen head bolts; SCH Pro-Drive 85V, 85H, 130V, 130H	SCP012766	\$157.77
Bearing block assembly 17mm, sealed bearing; Includes: nylon ring & 10mm allen head bolts; SCH Pro-Drive 85V, 85H, 130V, 130H	SCP014739	\$157.77
Bearing block assembly 27mm, greaseable bearing; Includes: nylon ring & 12mm hex head bolts; AGCO/MF 7200, 8200, 9250 (#71416424), Claas Maxi Flex, JD 600F, 600R, 600D, 600FD, 700FD, 925D, 930D, 936D	SCP014230	\$212.48
Bearing block assembly 27mm, sealed bearing; Includes: nylon ring & 12mm hex head bolts; AGCO/MF 7200, 8200, 9250 (#71416424), Claas Maxi Flex, JD 600F, 600R, 600D, 600FD, 700FD, 925D, 930D, 936D,	SCP014742	\$212.48
Bolt, 10mm x 35mm allen head	SCP010099	\$0.54
Bolt, 12mm x 45mm hex head	SCP010114	\$3.08
Bearing, for greaseable bearing block	SCP010258	\$119.71
Nylon ring, for Pro-Drive knifehead	SCP012543	\$10.09

## SCH Pro-Drive Hydraulic Motor Adapters

Description	Product ID	Price
Adapter, for 25.4mm (1") shaft	SCP012573	\$77.01
Adapter, for 31.7mm (1-1/4") shaft	SCP012563	\$77.01
Adapter, for 32.0mm shaft	SCP012564	\$77.01

Only Used with Horizontal Pro-Drives

## SCH PRO-DRIVE KIT FOR CUSTOM APPLICATIONS

Kit includes: SCH horizontal or vertical pro-drive, mounting plate, knifehead, and a hydraulic motor mounting bracket.

### SCH Pro-Drive Kits For Custom Applications

Description	Product ID	Price
SCH Horizontal Pro-Drive custom kit, for hydraulic motor driven applications.	SCK100180	\$2,150.00
Hydraulic Motor, 100cc, 1.25" shaft (optional)	SCP027906	\$625.00
SCH Vertical Pro-Drive custom kit, for belt driven applications.	SCK100190	\$2,295.00

**Note:** Custom Pro-Drive kits must be used in conjunction with a SCH EasyCut II cutting system.



Horizontal drive shown

## Reduce Vibration

**JOHN DEERE  
STABILIZER KIT**  
Recommended for John  
Deere 25' - 30' Flex Heads  
to Reduce Vibration



### John Deere Stabilizer Kit

Description	Product ID	Price
Stabilizer kit, for John Deere 900 series flex heads	SCP082802	\$281.00

### Stabilizer Replacement Parts

Description	Product ID	Price
Tie rod assembly (1)	SCP082706	\$119.00
Bracket, anchor (2)	SCP082707	\$23.00
Bracket, angle (3)	SCP082708	\$160.00
"H" bracket (4)	SCP082709	\$34.00

# RADURA REPLACEMENT GUARDS

**Forged  
Replacement  
Guards**



**John Deere**  
HRV133982

- **High wear resistance**
- **High stability**
- **Great strength**



**Case IH**  
HRV129901



**Case IH**  
HRV121501



**John Deere**  
HRV124002



**John Deere**  
HRV134000



**John Deere**  
HRV187011



**John Deere**  
HRV134051



**MacDon**  
HRV118301

## Radura Guards

Model	Product ID	Description	OEM#	Price
<b>AGCO</b>				
Series 3, 300, 400, 500, 700, 800, 7000, 8000, 8200, 9250	HRV122500	Guard, 2-point, double hardened	71341601, 71116504 71386962	\$12.70
<b>Case-IH</b>				
820, 1010, 1020, 2010, 2020 (CBJ020001 & up)	HRV000329	Head guard, 2-point, double hardened	1326787C3, 87442329	\$24.48
1010, 1020, 2010, 2020 (CBJ020001 & up)	HRV129901	Guard, 2-point, without trash bar, double hardened	1307299C2, 877442324 334305A1	\$15.62
2010, 2020 (prior to CBJ020000 & all HAJ)	HRV121501	Guard, 2-point, with trash bar, 4-1/4" long, double hardened	86615982, 700707147	\$15.73
1042, 1052, 2042, 2052, 2062, 2142, 2152, 2162	HRV183442	Guard, 2-point, double hardened	47687886, 87421451	\$14.43
	HRV118301	Guard, LH end guard, 2-point, double hardened	47709129, 87422039	\$17.50
	HRV118302	Guard, RH end guard, 2-point, double hardened	47709128, 87422040	\$17.50
	HRV118345	Head guard, 2-point, double hardened	47709127, 87422041	\$16.95
2142, 2152, 2162	HRV124338	Guard, bottom center guard, overlap, 2-point, double hardened	47709132, 87561546	\$22.69
	HRV124344	Guard, top center guard, overlap, 2-point, double hardened	47709134, 87561096	\$22.65
3020, 3152, 3162	HRV129730	Guard, 2-point, double hardened	87702973	\$16.16
	HRV129740	Head guard, 2-point, double hardened	87702974	\$24.38
<b>John Deere</b>				
200, 900	HRV124002	Guard, 2-point, double hardened	H113571, H145791 H153719, H171031	\$13.13
	HRV134000	Guard, 3-point, double hardened	H25603, H171032 H153855	\$22.00
600F, 600FD, 700FD, HDF, RDF Standard blunt point guard	HRV133982	Guard, 3-point, double hardened, long-short-long	H213398, H229537	\$21.03
	HRV135072	Guard, 3-point, double hardened, short-long-short	H213507, H229538	
600F, 600FD, 700FD No-till blunt point (no cross bar)	HRV187021	Guard, 3-point, double hardened, long-short-long	H218702	\$17.03
	HRV187011	Guard, 3-point, double hardened, short-long-short	H218701	
600F, 600FD, 700FD Blunt point non-clog guard (no cross bar)	HRV187030	Guard, 3-point, double hardened, long-long-long Used in conditions where crop gets tangled	H218703	\$17.57
600FD, 700FD, HDF, HDR, RDF	HRV180141	Guard, 3-point, double hardened, overlap, RH	HXE19625	\$29.67
	HRV180143	Guard, 3-point, double hardened, overlap, LH	HXE18172	\$29.67
	HRV180142	Guard, 3-point, double hardened, center guard	AH226928	\$29.67
600D, 600R, 900D Long point guard	HRV134051	Guard, 3-point, double hardened, long-short-long	H213405, H229539	\$18.32
	HRV135081	Guard, 3-point, double hardened, short-long-short	H213508, H229540	

Continued on next page.

# RADURA REPLACEMENT PARTS

Radura Guards (Continued)				
Model	Product ID	Description	OEM#	Price
<b>John Deere Continued</b>				
600D, 600R, 900D Long point non-clog guard (no cross bar)	HRV187030	Guard, 3-point, double hardened, long-long-long Used in conditions where crop gets tangled	H218703	\$17.57
<b>MacDon</b>				
960, 962, 963, 972, 973, 974, D40, D50, D60, D65, D1, FD70, FD75, FD1	HRV183442	Guard, 2-point, double hardened	118344, 118484	\$14.43
	HRV118301	Guard, LH end guard, 2-point, double hardened	118301	\$17.50
	HRV118302	Guard, RH end guard, 2-point, double hardened	118302	\$17.50
	HRV118345	Head guard, 2-point.	118345	\$16.95
D50, D60, D65, D1, FD70, FD75, FD1	HRV124338	Guard, bottom center guard, overlap, 2-point, double hardened	124338	\$22.69
	HRV124344	Guard, top center guard, overlap, 2-point, double hardened	124344	\$22.65
<b>Massey Ferguson</b>				
9250	HRV122500	Guard, 2-point, double hardened	71341601, 71116504 71386962	\$12.70
<b>New Holland</b>				
84C, 86C	HRV183442	Guard, 2-point, double hardened	47687886, 87421451	\$14.43
	HRV118301	Guard, LH end guard, 2-point, double hardened	47709129, 87422039	\$17.50
	HRV118302	Guard, RH end guard, 2-point, double hardened	47709128, 87422040	\$17.50
	HRV118345	Head guard, 2-point, double hardened	47709127, 87422041	\$16.95
72C, 74C	HRV000329	Head guard, 2-point, double hardened	1326787C3, 87442329	\$24.48
740CF, 840CD, 880CF	HRV129730	Guard, 2-point, double hardened	87702973	\$16.16
	HRV129740	Head guard, 2-point, double hardened	87702974	\$24.27

## RADURA REPLACEMENT SECTIONS

**GREAT RESULTS** whether it is grain,  
soybeans, or grass crops

- Self-sharpening cutting edges
- Made from high quality steel
- Various serrations available



Radura Sections				
Model	Description	Product ID	OEM#	Price
<b>AGCO</b>				
Series 3, 300, 400, 500, 700, 800, 7000, 8000, 8200, 9250	Box of 25, coarse, 7 teeth per inch	SCP011003	71135135, 71348175	\$53.78
	Box of 25, fine, 11 teeth per inch	SCP011001	71135135, 71348175	\$53.78
	Hardware, pkg of 50, 5/8" long ribbed bolts & locknuts	RSP042737	n/a	\$16.76
<b>Case-IH</b>				
820, 1010, 1020, 2010, 2020	Box of 25, 9 teeth per inch	RSP080140	112074A1	\$41.08
	Hardware, pkg of 50, 5/8" long ribbed bolts & locknuts	RSP042737	n/a	\$16.76
1042, 1052, 2042, 2052, 2062, 2142, 2152, 2162	Box of 25, coarse, 7 teeth per inch	RSP041830	87422066	\$48.10
	Box of 25, fine, 14 teeth per inch	RSP041826	1327448C1	\$48.10
	Hardware, pkg of 50, 5/8" long ribbed bolts & locknuts	RSP042737	n/a	\$16.76
3020, 3152, 3162	Box of 25, 11 teeth per inch	RSP054340	87728905	\$48.92
<b>Claas</b>				
	Box of 25, coarse, 7 teeth per inch	RSP052494	7679360	\$50.00

Continued on next page.

# RADURA REPLACEMENT PARTS

Radura Sections (continued)				
Model	Description	Product ID	OEM#	Price
<b>John Deere</b>				
200, 900	Box of 25, coarse, 7 teeth per inch	RSP010992	H160251, H168316, H207930	\$41.08
	Box of 25, fine, 11 teeth per inch	RSP080017	H136807, H207929	\$41.62
	Hardware, pkg of 50, 5/8" long ribbed bolts & locknuts	RSP042737	n/a	\$16.76
600F, 600R, 600D, 600FD 700D, 700FD, 900D HDF, HDR, RDF	Box of 25, coarse, 7 teeth per inch, plated	RSP080010	H163131	\$78.64
	Box of 25, fine, 14 teeth per inch, plated	RSP080011	H153329	\$78.64
	Box of 25, fine, 14 teeth per inch, unplated	RSP080013	H153329	\$35.62
	Hardware, pkg of 50, 6mm long bolts & locknuts	RSP080079	n/a	\$27.84
<b>MacDon</b>				
960, 962, 963, 972, 973, 974, D50, D60, D65, D1, FD70, FD75, FD1	Box of 25, coarse, 7 teeth per inch	RSP041830	102053, 158516	\$48.10
	Box of 25, fine, 14 teeth per inch	RSP041826	174852, 174853, 118491	\$48.10
	Hardware, pkg of 50, 5/8" long ribbed bolts & locknuts	RSP042737	n/a	\$16.76
<b>New Holland</b>				
970, 971, 972, 973	Box of 25, coarse, 7 teeth per inch	SCP011007	848091	\$53.78
	Box of 25, fine, 11 teeth per inch	SCP011005	848091	\$53.78
	Hardware, pkg of 50, 5/8" long ribbed bolts & locknuts	RSP042737	n/a	\$16.76
84C, 86C	Box of 25, coarse, 7 teeth per inch	RSP041830	87422066	\$48.10
	Box of 25, fine, 14 teeth per inch	RSP041826	1327448C1	\$48.10
	Hardware, pkg of 50, 5/8" long ribbed bolts & locknuts	RSP042737	n/a	\$16.76
740CF, 840CD, 880CF	Box of 25, fine, 11 teeth per inch	RSP054340	87728905	\$48.92

## RADURA COMPLETE KNIFE ASSEMBLIES

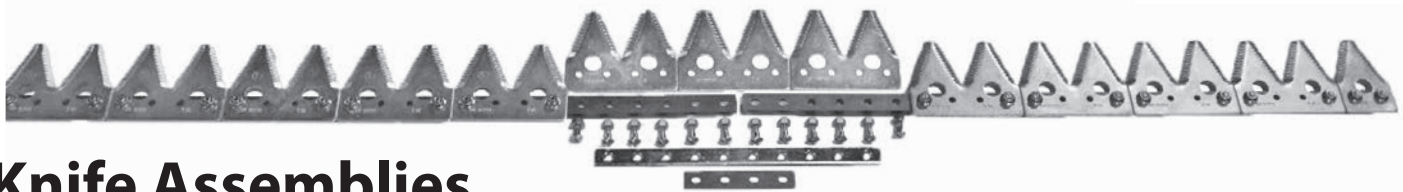

### Knife Assemblies

- Available in coarse or fine serrated sections
- Small parcel shippable
- Hardware is included
- OEM quality parts
- Sectionalized for easy transport

Case-IH	3" Sections		Coarse (9-TPI)	Fine	Price
1010, 1020 (Knifehead Included)	17.5'	Single Drive	RSP080159	n/a	\$469.52
	20'	Single Drive	RSP080160	n/a	\$514.57
	22.5'	Single Drive	RSP080161	n/a	\$555.51
	25'	Single Drive	RSP080162	n/a	\$573.50
	30'	Single Drive	RSP080163	n/a	\$678.04

Continued on next page.

# RADURA REPLACEMENT PARTS

Case-IH/ MacDon	3" Sections		Coarse (7-TPI)	Fine (14-TPI)	Price
2142, 2152, 2162 D50, D60, D65, D1 FD70, FD75, FD1 (Knifehead(s) NOT Included)	15'	Single Drive	RSP080972	RSP080973	\$333.55
	20'	Single Drive	RSP080974	RSP080981	\$459.37
	25'	Single Drive	RSP080871	RSP080886	\$594.53
	30'	Single Drive	RSP080872	RSP080887	\$689.06
	35'	Single Drive	RSP080873	RSP080888	\$818.88
	40'	Single Drive	RSP080874	RSP080889	\$950.04
	45'	Single Drive	RSP080875	RSP080890	\$1,044.56
	20'	Double Drive	RSP210641	RSP210646	\$484.31
	25'	Double Drive	RSP210841	RSP210846	\$634.91
	30'	Double Drive	RSP211041	RSP211046	\$785.53
	35'	Double Drive	RSP211141	RSP211146	\$839.79
	40'	Double Drive	RSP211241	RSP211246	\$990.41
	45'	Double Drive	RSP211341	RSP211346	\$1,141.04
	John Deere	3" Sections		Coarse (7-TPI)	Fine (11-TPI)
200, 900 Auger Platforms (Knifehead Included)	18'	Single Drive	RSP080044	RSP080019	\$420.58
	20'	Single Drive	RSP080045	RSP080020	\$452.47
	22'	Single Drive	RSP080046	RSP080021	\$481.76
	24'	Single Drive	RSP080047	RSP080022	\$510.98
	25'	Single Drive	RSP080048	RSP080023	\$551.75
	30'	Single Drive	RSP080049	RSP080024	\$622.42
John Deere	4" Long-Long Sections		Coarse (7-TPI)	Fine (14-TPI)	Price
600 HydraFlex Auger Platforms (Knifehead NOT Included)	20'	Single Drive	RSP080084	RSP080059	\$527.57
	25'	Single Drive	RSP080085	RSP080060	\$669.57
	30'	Single Drive	RSP080086	RSP080061	\$831.93
	35'	Single Drive	RSP080087	RSP080062	\$953.60
600FD, 700FD, RDF Flex Draper Platforms (Knifehead(s) NOT Included)	30'	Single Drive	RSP080086	RSP080061	\$831.93
	30'	Double Drive	RSP031041	RSP031043	\$942.27
	35'	Double Drive	RSP031141	RSP031143	\$1,033.77
	40'	Double Drive	RSP031241	RSP031243	\$1,071.89
	45'	Double Drive	RSP031341	RSP031343	\$1,348.32
900D Draper Platforms (Knifehead NOT Included)	25'	Single Drive	n/a	RSP080060	\$669.57
	30'	Single Drive	n/a	RSP080061	\$831.93
	36'	Single Drive	n/a	RSP080609	\$981.63
John Deere	4" Long-Short Sections		Coarse (7-TPI)	Fine (14-TPI)	Price
600 HydraFlex Auger Platforms (Knifehead NOT Included)	20'	Single Drive	RSP020612	RSP020614	\$527.57
	25'	Single Drive	RSP020912	RSP020914	\$669.57
	30'	Single Drive	RSP021012	RSP021014	\$831.93
	35'	Single Drive	RSP021112	RSP021114	\$953.60
600FD, 700FD, RDF Flex Draper Platforms (Knifehead(s) NOT Included)	30'	Single Drive	RSP021012	RSP021014	\$831.93
	30'	Double Drive	RSP031042	RSP031044	\$942.27
	35'	Double Drive	RSP031142	RSP031144	\$1,033.77
	40'	Double Drive	RSP031242	RSP031244	\$1,071.89
	45'	Double Drive	RSP031342	RSP031344	\$1,348.32
900D Draper Platforms (Knifehead NOT Included)	25'	Single Drive	n/a	RSP020914	\$669.57
	30'	Single Drive	n/a	RSP021014	\$831.93
	36'	Single Drive	n/a	RSP021514	\$981.63

# PLATFORM REPLACEMENT PARTS



Platform Replacement Parts				
Make/Model	Description	Product ID	OEM#	Price
<b>AGCO</b>				
Series 3, 300, 400, 500, 800, 8000, 9250	Wear plate	HRV457001	71116532, 71176537	\$1.99
	Hold down, universal, steel	HRV457055	71346158	\$5.50
7200, 8200, 9250	Bearing block assembly, greaseable	SCP014230	ACP012440	\$212.48
	Bearing block assembly, sealed	SCP014742	71416424	\$212.48
	Nylon ring, for knifehead bearing	SCP012543	700719594	\$10.09
	Knifehead Clamp 7/8" (includes nylon ring)	SCP015056	700719594	\$103.44
<b>Case-IH</b>				
810, 820, 1010, 1020	Wear plate	HRV457001	179759C1	\$1.99
1010, 1020	Knifehead	RSP051520	1313795C95	\$128.79
2010, 2020, SMX91	Bearing assembly	HRV455053	701401	\$76.65
1042, 1052, 2042, 2052, 2062, 2142, 2152, 2162	Head pin	HRV455032	345893A1	\$37.50
	Needle bearing, knifehead	HRV455033	A27827	\$20.50
	Seal, knifehead	HRV455027	345892A1	\$9.99
	Plug, knifehead	HRV455028	395820A1	\$1.89
2142, 2152, 2162	Hold down	HRV052483	338591A1, 87407812	\$7.99
	Cutterbar skid shoe	MYW983840	129297	\$10.50
	Knifehead (LH or RH 25' and shorter)	RSP080967		\$122.90
	Knifehead (LH 30' and larger)	RSP080968	87561157	\$130.63
	Knifehead (RH 30' and larger)	RSP080969	87561158	\$133.91
<b>John Deere</b>				
200	Wear plate (1 on drive end)	HRV457002	E47954	\$1.99
200, 900	Wear plate (1 per foot)	HRV457005	H153157	\$1.99
	Hold down, steel	HRV457055	H84412	\$5.50
	Hold down, cast	HRV457094	H127801	\$3.75
	Hold down, cast (1 on drive end)	HRV457095	H129024	\$3.95
	Knifehead	RSP052094	AH121075	\$108.78
600F, 600D, 600R, 600FD, 700FD, 900D	Hold down-high (2 used)	HRV818548	AH218548, H218950	\$6.95
	Hold down-low (1 per foot)	HRV818547	AH218547, H218949	\$6.95
	Bearing block assembly, greaseable	SCP014230		\$212.48
	Bearing block assembly, sealed	SCP014742	AXE24816	\$212.48
600F	Nylon ring, for knifehead bearing	SCP012543	H157812	\$10.09
600F	Knifehead	RSP002559	AH220051	\$143.11
900D	Knifehead	RSP080573	AH220050	\$165.85
600FD, 700FD	Knifehead, LH & RH	HRV450125	AH231842	\$125.95
	Oval head bolt, M6-1mmx16mm	HRV458095	H158341	\$0.33
	Oval head bolt, M6-1mmx20mm	HRV458096	H158342	\$0.38
	Oval head bolt, M6-1mmx25mm	HRV458097	H158343	\$0.43
<b>MacDon</b>				
960, 962, 963, 972, 973, 974, D50, D60, D65, D1, FD70, FD75, FD130, FD135, FD140, FD145	Head pin	HRV455032	113299	\$37.50
	Needle bearing, knifehead	HRV455033	100500	\$20.50
	Seal, knifehead	HRV455027	113222	\$9.99
	Plug, knifehead	HRV455028	113937	\$4.25
	Hold down	HRV052483	118499, 118199	\$7.99
D50, D60, D65, FD70, FD75, FD130, FD135, FD140, FD145	Cutterbar skid shoe	MYW983840	129297	\$10.50
	Knifehead (LH or RH 25' and shorter)	RSP080967	120832	\$122.90
	Knifehead (LH 30' and larger)	RSP080968	132896	\$130.63
	Knifehead (RH 30' and larger)	RSP080969	132897	\$133.91
<b>New Holland</b>				
71C, 72C, 73C, 74C, 970, 971, 972, 973, 1465	Bearing assembly	HRV455053	701401	\$76.65
82C, 83C, 84C, 86C	Head pin	HRV455032	345893A1	\$37.50
	Needle bearing, knifehead	HRV455033	A27827	\$20.50
	Seal, knifehead	HRV455027	345892A1	\$9.99
	Plug, knifehead	HRV455028	395820A1	\$4.25
	Hold down	HRV052483	338591A1, 87407812	\$7.99
86C	Cutterbar skid shoe	MYW983840	129297	\$10.50
	Knifehead (LH or RH 25' and shorter)	RSP080967		\$122.90
	Knifehead (LH 30' and larger)	RSP080968	87561157	\$130.63
	Knifehead (RH 30' and larger)	RSP080969	87561158	\$133.91
<b>Universal</b>				
Universal	Hold down, universal	HRV457051	70804075	\$11.99

# PLASTIC WEAR BLOCKS



**Long-Lasting Self-Lubricating Plastic Chain Tightener and/or Wear Block with 9/16" Hole**

- Reduces chain wear and friction
- Saves labor, money and downtime
- Decreases wood block replacement
- Increases chain life and keeps chain tight
- Lasts 4 to 5 times longer than wood blocks

- Replaces any idler on chain driven equipment

Plastic Wear Blocks		
Product ID	Description	Price
CBM500000	Plastic wear block	\$8.50

# CASE-IH 1020 RUNNERS



SCP083684



SCP083685

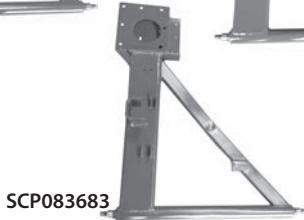

SCP083683

Case-IH 1020 Runners		
Product ID	Description	Price
HRV130784	Runner, Generation I, Greaseable, S/N JJC0215000 & lower	\$1,495.00
HRV393724	Runner, Generation III, Oil Bath, S/N JJC0215001 & up; CBJ023001 & up	\$1,495.00

# STUB SHAFTS

SCP083862



Stub Shafts		
Product ID	Description	Price
SCP083862	Stub shaft, Case-IH 1020 runner	\$50.50

# SCH HEDGE & BRANCH TRIMMERS

**FOR HEDGE/SHRUB MANAGEMENT, SPECIALTY CROPS & ORCHARDS**

**Straight, Smooth and Precision Cuts Encourage a Healthy Re-growth**



**Standard**  
(With Pro-Drive and hydraulic motor)

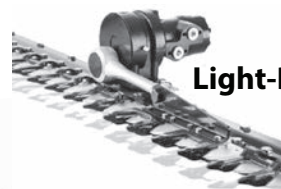

**Light-Duty**



**Extreme**



**AxeCut guards**



**Application Ranges:**

- Orchard vegetation management
- Specialty crop harvesting
- Hedge/shrub cutters; Roadside management

**Features:**

- Easy attachment to hydraulic reach arms, front loader and excavator arms.
- Individual positioning of knife drive; Customizable working widths & drive concepts

**Light-Duty Version:**

- Great stability and precision to cut up to 0.8 inch branches
- Lightweight design, for use on small machines; Compact build for optimum flow
- C-Drive system with a hydraulic motor for excellent performance in wet conditions due to reduced weight and compact build

**Standard Version:**

- Ability to cut one-inch branches
- Extra short SCH guards are bolted to the top and bottom of the bar
- High-efficiency Pro-Drive planetary knife driver combines with a hydraulic motor

**Extreme Version:**

- **Ability to cut 2.4 inch branches**
- Sturdy AxeCut guards are bolted to the cutterbar top & bottom. Serrated guard fingers ensure a firm grip and prevent branches from slipping off the cutter bar

SCH Hedge and Branch Trimmers		
Product ID	Description	Price
EWM120470	Hedge Trimmer, Light-Duty, 4'	\$3,325.00
EWM150590	Hedge Trimmer, Light-Duty, 5'	\$3,485.00
EWM120047	Hedge Trimmer, Standard, 4'	\$4,275.00
EWM150059	Hedge Trimmer, Standard, 5'	\$4,425.00
EWM180071	Hedge Trimmer, Standard, 6'	\$4,595.00
EWM210083	Hedge Trimmer, Standard, 7'	\$4,750.00
EWM240095	Hedge Trimmer, Standard, 8'	\$4,900.00
EWM270106	Hedge Trimmer, Standard, 9'	\$5,125.00
EWM300118	Hedge Trimmer, Standard, 10'	\$5,205.00
EWM170067	Branch Trimmer, Extreme, 6'	\$13,475.00
EWM200079	Branch Trimmer, Extreme, 7'	\$14,445.00
EWM240094	Branch Trimmer, Extreme, 8'	\$15,190.00

Visit our website for the most current product pricing [www.sidist.com](http://www.sidist.com)

# YETTER STALK DEVASTATOR

The 5000 Stalk Devastator is the field-proven solution from Yetter Farm Equipment. The rollers on the Devastator push stalks over, crimping them so they don't damage tires or tracks. Crimped stalks also promote faster decomposition and microbial breakdown of residue.



## Yetter Stalk Devastator Kits

AGCO	Model	Spacing	Spring Type	Vendor ID	Product ID	Price
6 Row Kit	Gleaner 3000, Hugger 630, MF 3000 (1988 & Newer); Challenger CH630	30"	Compression	5000-023C	YTR002323	\$5,130.00
8 Row Kit	Gleaner 3000, Hugger 630, MF 3000 (1988 & Newer); Challenger CH630	30"	Compression	5000-024C	YTR002324	\$6,840.00
	Gleaner 3308	30"	Compression	5000-035A	YTR002135	\$6,840.00
12 Row Kit	Gleaner 3312	30"	Compression	5000-039	YTR002039	\$10,260.00
Capello	Model	Spacing	Spring Type	Vendor ID	Product ID	Price
8 Row Kit	Quasar (non-chopping)	30"	Torsion	5000-041-LEX	YTR011041	\$7,830.00
12 Row Kit	Quasar (non-chopping)	30"	Torsion	5000-044-LEX	YTR011044	\$11,700.00
Case-IH	Model	Spacing	Spring Type	Vendor ID	Product ID	Price
6 Row Kit	3206, 3406 ❶	30"	Compression	5000-005B	YTR022205	\$5,130.00
	1063	30"	Compression	5000-013B	YTR022213	\$5,130.00
	2206	30"	Torsion	5000-040-CNH	YTR021040	\$5,130.00
	2606, 4206, 4406	30"	Torsion	5000-060E	YTR021360	\$5,130.00
8 Row Kit	3208, 3408 ❶	30"	Compression	5000-006C	YTR022306	\$6,840.00
	2608, 4208, 4408	30"	Torsion	5000-061E	YTR021361	\$6,840.00
	1083	30"	Compression	5000-014C	YTR022314	\$6,840.00
	4408 (folding) ❶	30"	Compression	5000-036	YTR022036	\$7,830.00
	2208, 2408 ❶	30"	Torsion	5000-041-CNH	YTR021041	\$6,840.00
12 Row Kit	2412, 3412 ❶	30"	Compression	5000-019C	YTR022319	\$10,260.00
	2212, 2412, 3212, 3412	20"	Torsion	5000-042D-CNH	YTR021242	\$6,840.00
	2212, 2412, 3212, 3412	22"	Torsion	5000-046D-CNH	YTR021246	\$6,840.00
	2612, 4412, 4412F; chopping (rigid & folding)	30"	Torsion	5000-062E	YTR021362	\$10,260.00
	4412; chopping (rigid)	20"	Torsion	5000-063E	YTR021363	\$6,840.00
Drago	Model	Spacing	Spring Type	Vendor ID	Product ID	Price
6 Row Kit	630 Series I & II	30"	Compression	5000-007D	YTR032407	\$5,130.00
6 Row Kit	GT; non-chopping	30"	Torsion	5000-050E	YTR031350	\$5,130.00
8 Row Kit	830 Series I & II	30"	Compression	5000-017D	YTR032417	\$6,840.00
8 Row Kit	GT; non-chopping	30"	Torsion	5000-051E	YTR031351	\$6,840.00
12 Row Kit	1230 Series I & II	30"	Compression	5000-018D	YTR032418	\$10,260.00
	GT; non-chopping; rigid & folding	30"	Torsion	5000-052E	YTR031352	\$10,260.00
	GT	20"	Torsion	5000-056B	YTR031056	\$6,840.00
16 Row Kit	GT; non-chopping	30"	Torsion	5000-053D	YTR031253	\$13,680.00
18 Row Kit	GT	20"	Torsion	5000-054C	YTR031154	\$12,060.00
	GT	22"	Torsion	5000-055C	YTR031155	\$12,060.00
Optional Equipment				Vendor ID	Product ID	Price
❶ Extension Kit: For use with chopping rolls. Calmer BT, Geringhoff XDC, or 360 Chain Rolls; moves location of rollers back 5" (requires two rollers)				5000-080	YTR5000080	\$94.50
Stand Extension Kit (Includes two) Deere 612 (2012 & Newer) & 712				5000-081	YTR5000081	\$495.00
Lift Kit				5000-082	YTR5000082	\$23.40
Devastator Lock Up Kit, 6 row (John Deere only)				5000-083	YTR5000083	\$135.00
Devastator Lock Up Kit, 8 or 12 row (John Deere only)				5000-084	YTR5000084	\$171.00

# YETTER STALK DEVASTATOR

- Prevents damage to tires, tracks, wires, and hydraulic hoses
- Quick and easy to install
- Solid steel construction ensures reliability and durability
- Preserves residue cover, reducing soil erosion and keeping stalks in place on windy days
- Will not interfere with most head cart trailers
- Knocks over and crimps stalks for faster decomposition and microbial breakdown of residue

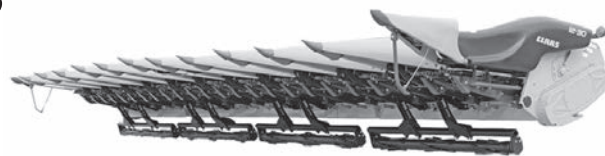

## Yetter Stalk Devastator Kits Continued

Fantini	Model	Spacing	Spring Type	Vendor ID	Product ID	Price
8 Row Kit	8R30 Fantini	30"	Compression	5000-031C	YTR042331	\$6,840.00
Geringhoff	Model	Spacing	Spring Type	Vendor ID	Product ID	Price
6 Row Kit	All models except Freedom	30"	Torsion	5000-040C-GER	YTR051140	\$5,850.00
8 Row Kit	All models except Freedom	30"	Torsion	5000-041C-GER	YTR051141	\$7,830.00
12 Row Kit	All models except Freedom; (rigid & folding)	30"	Torsion	5000-044C-GER	YTR051144	\$11,700.00
	All models except Freedom	20"	Torsion	5000-042C-GER	YTR051142	\$7,830.00
	All models except Freedom	22"	Torsion	5000-046C-GER	YTR051146	\$7,830.00
18 Row Kit	All models except Freedom (rigid & folding)	20"	Torsion	5000-045C-GER	YTR051145	\$12,060.00
	All models except Freedom (rigid & folding)	22"	Torsion	5000-047C-GER	YTR051147	\$12,060.00
John Deere	Model	Spacing	Spring Type	Vendor ID	Product ID	Price
6 Row Kit	643, 693, 606C, 706C, C6R	30"	Torsion	5000-040E	YTR061340	\$5,130.00
	644, 694, 606, 706, C6R	36" & 38"	Torsion	5000-091B	YTR061091	\$6,030.00
8 Row Kit	843, 893	30"	Compression	5000-026E	YTR062426	\$6,840.00
	844, 894, 608, 708, C8R	36" & 38"	Torsion	5000-092B	YTR061092	\$8,010.00
	608C, 708F, C8F (folding)	30"	Torsion	5000-048B	YTR061048	\$6,840.00
	608C, 708C, C8R (rigid)	30"	Torsion	5000-041E	YTR061341	\$6,840.00
12 Row Kit	1243, 1293	30"	Compression	5000-027E	YTR062427	\$10,260.00
	1290 (includes 5000-070 adapter kits)	20"	Torsion	(1) 5000-042E+ (6) 5000-070	YTR061370	\$7,731.00
	612C, 712C, C12R	22"	Torsion	5000-046E	YTR061346	\$6,840.00
	612C, 712C, C12R	20"	Torsion	5000-042E	YTR061342	\$6,840.00
	612C, 712C, C12R, C12F	30"	Torsion	5000-044E	YTR061344	\$10,260.00
	1244, 1294, 612, 712, C12R	36" & 38"	Torsion	5000-093B	YTR061093	\$11,700.00
16 Row Kit	616C, 716C, C16R, C16F	30"	Torsion	5000-049	YTR061049	\$13,680.00
18 Row Kit	618C, 718C, C18R, C18F	20"	Torsion	5000-045E	YTR061345	\$11,160.00
	618C, 718C, C18R, C18F	22"	Torsion	5000-047E	YTR061347	\$11,160.00
Lexion	Model	Spacing	Spring Type	Vendor ID	Product ID	Price
8 Row Kit	Lexion; non-chopping	30"	Torsion	5000-041-LEX	YTR011041	\$7,830.00
12 Row Kit	Lexion; non-chopping	30"	Torsion	5000-044-LEX	YTR011044	\$11,700.00
New Holland	Model	Spacing	Spring Type	Vendor ID	Product ID	Price
6 Row Kit	98D ❶	30"	Compression	5000-005B	YTR022205	\$5,130.00
	96C, 996	30"	Torsion	5000-040-CNH	YTR021040	\$5,130.00
	99C, 980CR (rigid)	30"	Torsion	5000-060E	YTR021360	\$5,130.00
8 Row Kit	98D ❶	30"	Compression	5000-006C	YTR022306	\$6,840.00
	96C, 98C, 996 ❶	30"	Torsion	5000-041-CNH	YTR021041	\$6,840.00
	99C, 980CR (rigid)	30"	Torsion	5000-061E	YTR021361	\$6,840.00
12 Row Kit	98C, 98D, 996 ❶	30"	Compression	5000-019C	YTR022319	\$10,260.00
	96C, 98D, & 996	20"	Torsion	5000-042D-CNH	YTR021242	\$6,840.00
	96C, 98D, & 996	22"	Torsion	5000-046D-CNH	YTR021246	\$6,840.00
	99C, 980CF, & 980CR; chopping (rigid & folding)	30"	Torsion	5000-062E	YTR021362	\$10,260.00
	9212; chopping (rigid)	20"	Torsion	5000-063E	YTR021363	\$6,840.00

# SUPER SPONGE WEED WIPERS

**Great for Glyphosate-Resistant Weeds and Non-GMO Applications**

**Super Sponge Weed Wipers' pump-fed sponges hold and put more material on undesired weeds, WITHOUT DRIFT.**



**Applicators have reported less than \$1 of chemical cost per acre.**

*"I got great results using Gramoxone at 50% to control resistant weeds in my soybeans" - BM, Fountain, AR*

*"I get \$5 more per bale when I use my weed wiper to get rid of the Johnson Grass in my hay." - JE, Denton, NC*

*"This product is unbelievable! Sponges worked as promised!" - WB, OV Park, KS*

**Attaches right to your self propelled sprayer boom**

Sprayer Boom		
Length	Product ID	Price
60'	WWP119060	\$4,599.00
80'	WWP119080	\$6,699.00
90'	WWP119090	\$7,199.00
100'	WWP119100	\$7,850.00
120'	WWP119120	\$9,159.00

Each 30" sponge section has a separate feed tube that adapts directly to the closest TeeJet or Hypro nozzle body. Nozzle body caps are also included to shut down any tip that is not feeding a sponge section. The special brackets, u-bolts, and risers allow you to easily attach the sponges to your boom quickly. The brackets also allow you to remove the sponges quickly without taking off the u-bolts.



**Build your weed wiper the way you want it**

Build your own custom weed wiper, or convert your old gravity fed weed wiper to a modern pump fed system. Mount this kit to a boom of your choosing. Wipe out taller growing weeds with no drift.



This unit requires:

- A spray tank
- A pump
- A boom of your choice
- Mounting brackets



**Top Crop (Build-Your-Own)**

Length	Product ID	Price
5'	WWP219105	\$199.00
10'	WWP219010	\$599.00
15'	WWP219015	\$899.00
20'	WWP219020	\$1,099.00
30'	WWP219030	\$1,599.00
40'	WWP219040	\$1,999.00

**Front Bucket**

Length	Product ID	Price
10'	WWP619010	\$1,199.00
15'	WWP619015	\$1,799.00
20'	WWP619020	\$2,199.00

**Mounts directly to your front loader bucket**

Mount this unit to your front bucket with our easy to install front bucket mounting brackets. Adjust the height on the go. The tank and pump is not included with this kit. We recommend using a minimum 3 GPM per minute pump.



# SUPER SPONGE WEED WIPERS CONT.



- Adjust height on the go by simply raising and lowering 3-point hitch.
- Includes tank and 12V pump for reliable herbicide delivery across all models.
- Folding wing design on 15' and larger models allows for compact transport and easy storage.
- Durable frame and components built to withstand rugged farm conditions and heavy use.

3-Point Hitch		
Length	Product ID	Price
7.5'	WWP319007	\$2,269.00
12.5'	WWP319012	\$2,799.00
17.5'	WWP319017	\$3,239.00
22.5'	WWP319022	\$3,699.00
27.5'	WWP319027	\$3,999.00
32.5'	WWP319032	\$4,629.00
25'	WWP319125	\$9,950.00

Five sections with gauge wheels to countour uneven ground. Optionl 12v or PTO Pump.

- Mounts easily to ATVs, UTVs, and front-end loader buckets.
- Adjustable mounting brackets make installation quick and compatible with a variety of setups.
- Ideal for hard-to-reach areas, pasture edges, fencerows, CRP fields, and compact plots.
- Requires tank and pump, spot sprayer type tanks work well for this application.

ATV		
Length	Product ID	Price
5'	WWP519105	\$499.00
5'	WWP519005	\$599.00
10'	WWP519010	\$1,199.00
15'	WWP519015	\$1,799.00

The 5' kits are priced as economy and standard. Economy is made from PVC.

UTV		
Length	Product ID	Price
5'	WWP719005	\$599.00
10'	WWP719010	\$1,199.00
15'	WWP719015	\$1,799.00
15'	*WWP719115	\$3,999.00

\*Includes hitch boom lift kit, and 50 gal 3 nozzle 30' boomless sprayer with gun.\*

Pull-Type		
Length	Product ID	Price
10'	WWP419010	\$3,099.00
15'	WWP419015	\$4,799.00
20'	WWP419020	\$4,499.00
25'	WWP419025	\$5,099.00
30'	WWP419030	\$5,999.00
40'	WWP419040	\$6,399.00

- Tows easily behind ATVs, UTVs, tractors, or other utility vehicles—ideal for large, open fields or pastures.
- Equipped with a tank and 12V pump for reliable herbicide delivery across all models.
- The wings on a pull type weed wiper (excluding the 20' unit) attach to the boom on a giant u joint. This allows the weed wiper to couture extremely well to uneven ground.
- The adjustable axels give you up to 40" of boom height adjustment.



## Optional Accessories

Descripton		Product ID	Price
UTV Hitch Boom Lift Kit	"Quickly mount weed wiper booms to 2'" receiver. Allows height adjustment by pulling and replacing the snap pin to the desired height "	WWP900020	\$299.00
	"Quickly mount weed wiper booms to 2'" receiver. Allows height adjustment up and down 17'" with manual crank. "	WWP900015	\$799.00
Power Lift	"12v powerlift kit works with ATV, UTV, & Front Bucket Weed Wipers. Attaches to 2'" receiver."	WWP900016	\$899.00
Front Bucket Brackets	"Easily attach ATV or 3-Point Hitch, Weed Wiper to a front bucket on your tractor. Brackets with with up to 2'" booms."	WWP900012	\$99.00
Auto Timer Chemical Control	Take the guess work out of controlling the flow of chemicals to the sponges.	WWP900017	\$399.00
3-Point Weed Wiper Stand	"Makes storage, set up, & attaching easier. It makes connecting to your tractor a ""one man"" job."	WWP900018	\$259.00

## Replacement Components

Descripton		Product ID	Price
30" Sponge With Net	Single	WWP900001	\$56.99
	Pack of 12	WWP900002	\$675.00
30" Net Replacement	Single	WWP900003	\$11.29
	Pack of 12	WWP900004	\$102.49
30" Sponge Assembly	Single	WWP900010	\$100.00
30" Heavy Duty Sponge Cover	Single	WWP900011	\$25.00



WWP900012



WWP900017

Visit our website for the most current product pricing [www.sidist.com](http://www.sidist.com)

# OUTBACK WRAP HYDRAULIC HOSE MARKERS

## End Criss-Crossed Hoses!

**A Simple Hose Identification System  
that's SIMPLY INGENIOUS!**

Outback Wrap is a "one-size-fits-all" identification wrap for hydraulic hoses that are **1/4" to 1-1/2"**.

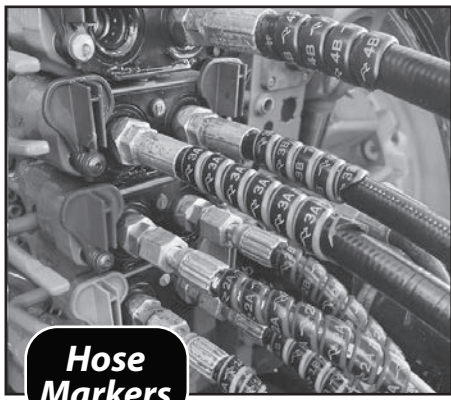

**Hose  
Markers**

- Can withstand temperatures to -60°F (-50°C) to 212°F (100°C)
- Not affected by grease, oil or dirt; it can be cleaned with any soap
- Made of polyethylene; the color is part of the molding process, so they will not fade or crack like other tags or identifiers
- No tools are required for installation.

**Outback Wraps are marked 1-6 and use the ISO color system for agricultural hydraulics:** 1=Green; 2=Blue; 3=Brown; 4=Black; 5=Purple and 6=Gray. Also "A" & "B" is lasered into the wrap to give a "left" and a "right", or an "above" and "below" indicator when hooking up. (A & B wraps are also cut to different lengths, giving an addition visual aid when looking at the hoses.)



#OBW002119



#OBW003833

Outback Wrap Hose Markers - Fits 1/4" to 1-1/2" hose		
Description	Product ID	Prc/Ea
4 pairs (remotes 1-4); green 1A & 1B, blue 2A & 2B, brown 3A & 3B, black 4A & 4B	OBW002119	\$20.99
2 pairs (remotes 1-2); green 1A & 1B, blue 2A & 2B	OBW002102	\$10.99
2 pairs (remotes 5-6); purple 5A & 5B, gray 6A & 6B	OBW002140	\$10.99
4 pairs; yellow + / -, blue + / -, red + / -, green, + / -	OBW003826	\$20.99
4 pairs; brown + / -, purple + / -, white + / -, black, + / -	OBW003840	\$20.99
2 pairs; brown + / -, purple + / -	OBW003833	\$10.99
Power Beyond Pack; pink "BRAKE", orange "TANK", white "LOAD SENSE", red "CASE DRAIN", yellow "PB PRESSURE", yellow "PB RETURN"	OBW002164	\$15.99
Fuel Finder; green "ROAD DIESEL", yellow "GASOLINE", red "DYED DIESEL", blue "DEF"	OBW003376	\$12.99



#OBW003376



#OBW002164

**Outback Wrap offers the Hose Tamer and the Hose Boss to bundle hoses, cables, cords and wires to keep them neat, organized and protected!**

## HYDRAULIC HOSE TAMERS

**Multiple-Hose Containment Wraps that Tame up to 14 Hoses!**

Outback Wrap Hose Tamer is the answer to messy and unruly hoses!  
The Hose Tamer is 1.5" (40mm) in diameter and 18" in length.

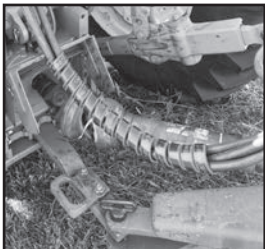

**Installs in  
seconds.**

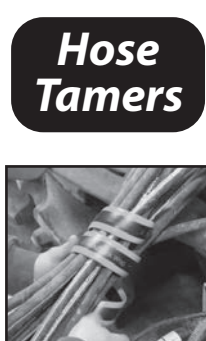

Outback Wrap Hose Tamers		
Description	Product ID	Prc/Ea
Hose Tamer, Green	OBW002157	\$12.99
Hose Tamer, Blue	OBW002158	
Hose Tamer, Red	OBW002159	
Hose Tamer, Yellow	OBW002160	
Hose Tamer, Orange	OBW003437	
Hose Tamer, Black	OBW002162	
Hose Tamer, Purple	OBW002163	
Hose Tamer, Gray	OBW002165	
Hose Tamer, White	OBW002166	
Hose Tamer, Pink	OBW002167	
Hose Tamer, Brown	OBW002161	

Outback Wrap, located in Faulkton, South Dakota, was created in 2018 by David Hedt, an Australian-born entrepreneur, who came up with the idea after he got tired of the frustrations of hooking up hydraulic hoses.

# OUTBACK WRAP HOSE BOSS

The Hose Boss is a "BIG step up" from the Hose Tamer!

The Hose Boss is a 4-foot long wrap, which is 3" in diameter (75mm). Made from heavy-duty polyethylene plastic, it is thick enough to contain a large number of hoses. It also features a punched hole in the end to strap hoses up.



Outback Wrap Hose Boss		
Description	Product ID	Price/Ea
Hose Boss, Green	OBW003000	\$31.99
Hose Boss, Blue	OBW003017	
Hose Boss, Red	OBW003024	
Hose Boss, Yellow	OBW003031	
Hose Boss, Orange	OBW003444	
Hose Boss, Black	OBW003604	

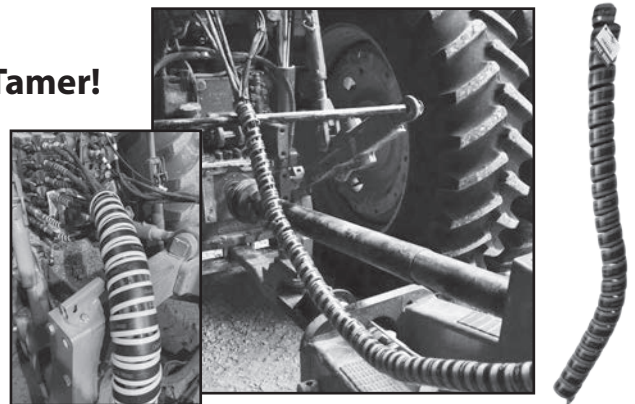

4-foot long wrap, 3" in diameter

# OUTBACK WRAP BULK WRAP "THE SNAKE COLLECTION"

Wrap your entire planter, other implements or electrical cables.

The Snake Collection can be used to bundle and contain hoses, wires, cables and cords on the farm, on equipment or at your business! Easy installation, no tools required! The Snake Collection is available in 160', 80', 50', 20', 15', 10' and 5' (please see chart below).



Constrictor



Snakelet



Honcho

Description	Length	Green	Blue	Red	Yellow	Orange	Black	Price/Ea
<b>Snaklet</b> (12mm) 1/2" Diameter	5'	OBW003673	OBW003680	OBW003697	OBW003703	OBW003857	OBW003864	\$5.99
	160'	OBW003871	OBW003888	OBW003895	OBW003901	OBW003918	OBW003925	\$135.00
<b>Constrictor</b> (16mm) 5/8" Diameter	20'	OBW003550	OBW003567	OBW003574	OBW003581	OBW003598	OBW003666	\$32.99
	80'	OBW003123	OBW003130	OBW003147	OBW003154	OBW003345	OBW003635	\$119.00
<b>Python</b> (20mm) 13/16" Diameter	15'	OBW003505	OBW003512	OBW003529	OBW003536	OBW003543	OBW003659	\$32.99
	80'	OBW003086	OBW003093	OBW003109	OBW003116	OBW003369	OBW003628	\$149.99
<b>Anaconda</b> (32mm) 1-1/4" Diameter	10'	OBW003451	OBW003468	OBW003475	OBW003482	OBW003499	OBW003642	\$32.99
	80'	OBW003048	OBW003055	OBW003062	OBW003079	OBW003352	OBW003611	\$189.99
Description	Length	Green	Blue	Red	Yellow	White	Black	Price/Ea
<b>Honcho</b> (90mm) 3-1/2" Diameter	8'	OBW003161	OBW003239	OBW003246	OBW003253	OBW003277	OBW003284	\$48.00
	50'	OBW003168	OBW003236	OBW003243	OBW003250	OBW003274	OBW003281	\$300.00



Python



Anaconda

# OUTBACK WRAP BAT WRAP

The Outback Wrap Bat Wrap is a heavy duty velcro wrap used to bundle and lift hoses, cables or wires, up to 700 pounds, out of the way. It is very easy to use. Just wrap the Bat Wrap around the hoses, cables or wires and secure with a tarp strap or rope. (Tarp strap or rope is not included.)

Bat Wrap is made from polypropylene and is 21" x 1-1/2". It has velcro fasteners and includes a stainless steel loop.

Outback Wrap Bat Wrap can lift up to 700 pounds (318kg).

The maximum bundle diameter is up to 5".

Outback Wrap Bat Wrap		
Description	Product ID	Price/Ea
Bat Wrap	OBW003420	\$12.99



Butterfly Stainless Steel Hose Clamps			
Color	Description	Product ID	Price/Ea
Green	Bag of 10	OBW003291	\$7.49
Blue	Bag of 10	OBW003260	
Brown	Bag of 10	OBW003413	
Black	Bag of 10	OBW003406	
Purple	Bag of 10	OBW003390	
Gray	Bag of 10	OBW003383	
Red	Bag of 10	OBW003710	
Yellow	Bag of 10	OBW003727	
White	Bag of 10	OBW003734	
Pink	Bag of 10	OBW003741	
Orange	Bag of 10	OBW003758	
Lime	Bag of 10	OBW003765	
Peacock	Bag of 10	OBW003772	\$19.99
Mix	2 of each of 13 colors	OBW003789	

# BUTTERFLY STAINLESS STEEL CLAMPS

Outback Wrap's Stainless Steel Butterfly Hose Clamps will make identifying and securing hoses over a fitting easy. These clamps are used to secure hoses to ports if they come disconnected easily. These butterfly clamps have a plastic turn key, making it easy to put on and take off of your hoses and lines.

With 13 color options, these Butterfly Hose Clamps do more than hold your hose in place, they will help identify hoses, pipes and connections more easily.



# THE SURE STOP



## Grain Handling Alignment Sensor

90 Decibel Alarm and LED light signals your exact stopping position.

- Perfect alignment every time.
- Save time and save steps.

**Makes Alignment an Easy One-Person Job!**



Product ID	Description	Price
WPS100000	The Sure Stop Kit	\$675.00
WPS200000	Reflective Tape, 8" piece	\$1.50

# LOCKEASE HITCH PINS

Lockease Hitch Pins		
Product ID	Description	Price
LEP010001	Lockease hitch pin, 3/4" x 6"	\$26.95
LEP010002	Lockease hitch pin, 7/8" x 6"	\$28.25
LEP010003	Lockease hitch pin, 1" x 6"	\$31.85
LEP010004	Lockease hitch pin, 1-1/8" x 7"	\$36.25
LEP010005	Lockease hitch pin, 1-1/4" x 7"	\$39.75
LEP010006	Lockease hitch pin, 1-1/2" x 8"	\$45.50
LEP010008	Lockease hitch pin, 3/4" x 4-1/2"	\$23.75
LEP010009	Lockease hitch pin, 7/8" x 4-1/2"	\$27.25
LEP010010	Lockease hitch pin, 5/8" x 4-1/2"	\$23.25
LEP080005	Lockease repair kit, includes thumb latch, spring & roll pin	\$7.50

**"Never Look Back!"**

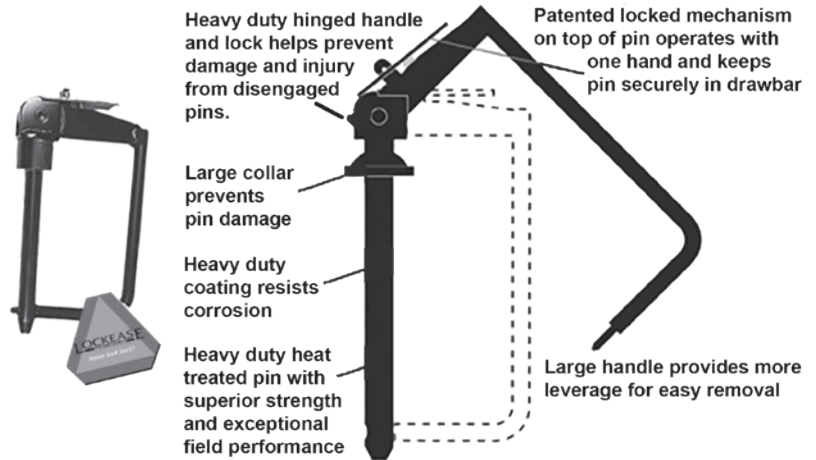

# EZ CUT SEAL REMOVER

Safely removes and holds seals from chemical containers without making contact with dangerous chemicals!

1. **Insert the Tool:** Place the EZ-Cut seal remover into the jug opening.
2. **Twist to Lock:** Give the tool a half twist, the seal will stay securely in the remover.
3. **Collect Foils:** Continue removing seals; as the foils start to pile up in the tool...
4. **Eject Foils:** Insert the ejection tool into the seal remover to release all collected foils quickly and easily.



EZ Cut Seal Removal		
Description	Product ID	Price
EZ Cut Seal Removal	CNT009001	\$41.50

- **5-Year Warranty**
- Weather stripping creates a tight seal against dust and moisture
- 16 gauge steel or .100" thick tread aluminum construction
- Welded seams, no spot welding
- Powder coated with a tough, scratch resistance, textured, powder paint



**DX411B**  
\*Tools not included



**XL450B**  
Mount to combine, tractor, truck, ATV and much more.



Montezuma Portable Steel Tool Boxes			
Product ID	Vendor ID	Description	Price
CPL411000	DX411B	Tool Box, 41" x 18" x 21-5/8"; Black Steel; 107 lbs; Organizes 280+ Tools/Accessories; Power Socket; Personal Locker Space	\$844.99
CPL364500	XL450B	Tool Box - 36"W x 17-3/8"D x 21-1/2"H; Black Steel; 91 lbs; Organizes 280+ Tools	\$744.99
CPL003100	LA400B	Tool Box - 30"W x 19"D x 20-1/8"H; Black Steel; 89 lbs; Organizes 269+ Tools/Accessories	\$709.99
CPL002203	ME300AL	Tool Box - 30"W x 15"D x 18-1/8"H, Brite Aluminum; 51 lbs; Organizes 140+ Tools/Accessories	\$739.99
CPL002200	ME300B	Tool Box - 30"W x 15"D x 18-1/8"H; Black Steel; 65 lbs; Organizes 140+ Tools/Accessories	\$579.99
CPL001200	SM200B	Tool Box - 22-1/2"W x 13"D x 14-1/8"H; Black; Organizes 129+ Tools/Accessories	\$389.99

Montezuma Toolbox Replacement Parts		
Product ID	Description	Price
CPL009106	Cylinder, SM 200	\$25.00
CPL009105	Cylinder, ME300	\$30.00
CPL009107	Cylinder, LA400, XL450	\$30.00
CPL009112	Latch, Square Handle	\$47.35

## SCHUCK CUSHION HITCHES

Schuck 300 Series Hitches		
750 lbs tongue weight, 20,000 lbs. pulling capacity		
Product ID	Description	Price
SHU103400	Model 340, 2" receiver tube cushion hitch	\$425.00
SHU103401	Model 340, 2.5" receiver tube cushion hitch	\$475.00
Schuck 700 Series Hitches		
1,000 lbs tongue weight, 40,000 lbs. pulling capacity		
SHU107402	Model 740, 2" receiver tube cushion hitch	\$610.00
SHU107403	Model 740, 2.5" receiver tube cushion hitch	\$655.00
SHU107507	Model 750 RTR, 2" receiver tube cushion hitch with pullout swivel; 3-1/2" drop from center of receiver tube to top of tongue	\$1,025.00
SHU107509	Model 750 RTR, 2.5" receiver tube cushion hitch with pullout swivel; 3-1/2" drop from center of receiver tube to top of tongue	\$1,060.00
SHU107505	Model 750 RT, 2" receiver tube cushion hitch with pullout swivel; 5-1/2" drop from center of receiver tube to top of tongue	\$1,025.00
SHU107510	Model 750 RT, 2.5" receiver tube cushion hitch with pullout swivel; 5-1/2" drop from center of receiver tube to top of tongue	\$1,060.00
Schuck 800 Series Hitches		
2,000 lbs tongue weight, 50,000 lbs. pulling capacity		
SHU108400	Model 840, 2" receiver tube cushion hitch	\$820.00
SHU108401	Model 840, 2.5" receiver tube cushion hitch	\$860.00
Schuck Parts & Accessories		
SHU900300	300 Series replacement kit; 2 cushions, 3 bearings	\$75.00
SHU900700	700 Series replacement kit; 4 cushions, 5 bearings	\$135.00
SHU900800	800 Series replacement kit; 6 cushions, 7 bearings	\$180.00

## Swivel Tongue For Quick, Easy Hook-ups

*Eliminate the frustrating job of backing into an exact position for hookup.*

The telescoping, swivel cushion tongue extends out a full (7) seven inches beyond the "Tow" position and swivels 60° laterally (or 12" left to right) for fast, easy hook-ups.



**Save time and effort on every hook-up,** and that means saving money for you.

### Absorbs Minor and Major Shocks

**A. Urethane Tips "Compress" to Absorb Minor Shocks!**

**B. Urethane Cushions "Compress" to Absorb Major Shocks!**

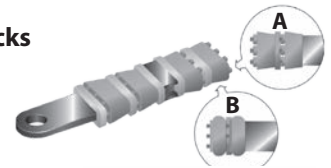

**Model 750 RT**

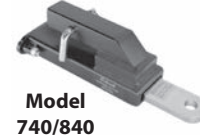

**Model 740/840**



**Model 340**

Schuck Bumper/Bolt On Hitch		
Product ID	Description	Price
SHU107500	Model 750, cushion hitch with pullout swivel	\$1,025.00
SHU001000	Model 1000 heavy duty bumper; Must order mounting brackets, stone shield and hitch to complete	\$785.00
SHU900001	Stone shield, for Schuck bumper	\$83.00
	Mounting brackets, for Schuck bumper; specify frame measurement	\$246.00

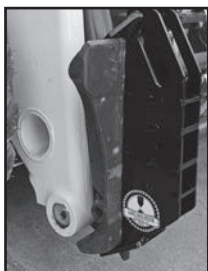

## SKID STEER HITCH

*Moving trailers and wagons around the farmyard with your skid steer is very easy with the lightweight and portable Skid Steer Hitch.*

This handy attachment allows you to quickly add a standard 2" trailer hitch receiver (not included) to your skid loader so you can move trailers around your farm yard with your skid steer. Lightweight and easy to install and remove, it will fit right in your truck toolbox! NOTE: 2" standard receiver and ball hitch sold separately.

Skid Steer Hitch		
Description	Product ID	Price
Skid Hitch	MYW083884	\$195.00



# VISIONWORKS WIRED CAMERA SYSTEMS

Quality, Durable, Affordable

## 5", 7" and 10" Wired Camera Systems Available Option: A.I. Camera with Pedestrian Detection

### 5" Wired Camera System

### 7" Wired Camera System

**1080p**  
FULL HD



**3 YEAR**  
CAMERA  
WARRANTY

### 10" Wired Camera System

Includes:

- 5", 7" or 10" Heavy Duty 1080P HD Monitor
- Weatherproof 1080P HD Camera with Magnet
- 15' or 30' Extension Cable

### A.I. Wired Camera Systems with Pedestrian Detection



**Pedestrian Detection**

#### High Definition Wired Camera Systems

Description	Camera(s) Included	Camera Input(s)	Cable Length	Product ID	Price
5" High Definition System (Skid-Steer Special)	1	3	15'	VWC152321	\$359.00
7" High Definition System	1	3	30'	VWC172323	\$379.00
10" High Definition System with Quad View	1	4	30'	VWC102423	\$649.00

#### High Definition Wired Camera Systems With A.I. Pedestrian Detection

Description	Camera(s) Included	Camera Input(s)	Cable Length	Product ID	Price
5" HD System with Pedestrian Detection (Skid-Steer Special)	1	3	15'	VWC152331	\$429.00
7" HD System with Pedestrian Detection	1	3	30'	VWC172333	\$449.00
10" HD System with Pedestrian Detection	1	4	30'	VWC102433	\$719.00

#### High Definition Wired Camera Systems With Recording

Description	Camera(s) Included	Camera Input(s)	Cable Length	Product ID	Price
7" High Definition System (1080P System w/ DVR)	1	4	30'	VWC704000	\$499.00
10" High Definition System (1080P System w/ DVR)	1	8	30'	VWC104210	\$799.00

#### Wired Back Up Camera Systems

Description	Camera(s) Included	Camera Input(s)	Cable Length	Product ID	Price
5" License Plate Cam System	1	1	30'	VWC152153	\$349.00

#### Add-On Camera/Cable Packages

Camera Type	Cable Length	Product ID	Price
<b>High Definition 1080p</b> (Adjustable between standard 90° & wide 140° viewing angles)	15' Cable	VWC909515	\$167.00
	30' Cable	VWC909530	\$172.00
	65' Cable	VWC909565	\$183.00
<b>High Definition 1080p</b> With AI Pedestrian Detection	15' Cable	VWC915715	\$227.00
	30' Cable	VWC915730	\$232.00
	65' Cable	VWC915765	\$243.00

# VISIONWORKS WIRED CAMERA SYSTEMS

Quality, Durable, Affordable



## 5", 7" and 9" Wireless Camera Systems Quad-View Recording Monitor with a Wireless Camera



- Watch and Record up to 4 Cameras
- Heavy-Duty Wireless Camera
- 1,000 Feet of Line of Sight Range
- Cup Holder Monitor Mount (5" & 7")
- Night Vision (17 IR LEDs)
- One-Way Audio

**1080p**  
FULL HD



### High Definition Wireless Camera Systems With Recording

Description	Camera(s) Included	Camera Input(s)	Cable Length	Product ID	Price
5" Touchscreen Wireless HD System w/ DVR	1	4	n/a	VWC253420	\$459.00
7" Touchscreen Wireless HD System w/ DVR	1	4	n/a	VWC273420	\$529.00
10" Touchscreen Wireless HD System w/DVR	1	4	n/a	VWC203420	\$649.00

### Wireless Grain Truck Load Out Camera System

Description	Camera(s) Included	Camera Input(s)	Cable Length	Product ID	Price	Extra Screen
						Additional Screen / Receiver
7" Truck Load Out System	1	3	30'	VWC722111	\$436.00	VWC900183 \$246.50

### Truck Load-Out Camera System Kit



**TRUCK(S) LOADING:**  
Watch from the top of the auger



### Camera System Accessories

#### Wired Cameras/Accessories

Description		Product ID	Price
Camera, High Definition 1080p	Adjustable between standard 90° & wide 140° viewing angles. Works with all wired systems.	VWC900095	\$139.00
Camera, A.I. Pedestrian Detection, 1080p	Works with all wired systems.	VWC900157	\$199.00
Camera, Standard Definition, License Plate	Slotted holes to bolt above license plate	VWC900110	\$99.00
High Definition Wireless Transmitter/Receiver	Allows wired cameras to transmit wirelessly.	VWC900042	\$219.00

#### Wireless Cameras / Accessories

Description		Product ID	Price
Wireless Camera, High Definition 1080p	Adjustable between standard 90° & wide 140° viewing angles	VWC900101	\$199.00
Rechargeable Battery Pack	12 volt power for wireless cameras	VWC900019	\$149.00
110v Power Adapter	Connects to 110v receptacle converts to 12v to power camera.	VWC900013	\$12.00
Omni Directional Antenna	Long-range booster antenna	VWC240014	\$29.00

#### Cables

Description	Product ID	Price
15' Cable	VWC901500	\$28.00
30' Cable	VWC903000	\$33.00
65' Cable	VWC906500	\$44.00

### Skid Steer Loader Camera System Kit



**SKID STEER LOADERS:**  
Increase safety by eliminating blind spots



# GPS/OEM SYSTEM CAMERA ADAPTER KITS

**Use What You Have for Less Clutter in the Cab:** These kits include a camera, cable, and adapter which allows you to easily plug into your existing screen / guidance system. Options available for most camera-capable GPS Systems.

AGCO		Product ID	Price
C1000	Camera/Cable Bundle with adapter, requires AGCO harness AC-A1C, includes 30' of cable	VWC806000	\$199.00
C2000	Camera/Cable Bundle with adapter, requires AGCO harness AC-A2C, includes 30' of cable	VWC806110	\$199.00
C2200, C3000	Camera/Cable Bundle with adapter, requires AGCO harness BUSB1-TC, includes 30' of cable	VWC806100	\$199.00
Fendt Tractors	Camera/Cable Bundle with Vairo Terminal adapter, includes 30' of cable	VWC807300	\$199.00
Datatronic 5, Fieldstar 5, NT03	Camera/Cable Bundle with adapter to connect input on back of armrest, includes 30' of cable	VWC806130	\$199.00
	Camera/Cable Bundle with adapter, connects to input on display, includes 30' of cable	VWC806140	\$229.00
Camera Ready Baler, Datatronic 5	Camera/Cable Bundle with adapter, includes two 6' of cables	VWC800101	\$229.00
Camera Ready Baler, Fendt Display	Camera/Cable Bundle with adapter, includes two 6' of cables	VWC800102	\$229.00
Ag Leader		Product ID	Price
Integra; Versa	Camera/Cable Bundle with 4 input monitor harness, includes 30' of cable	VWC800103	\$299.00
	Add-On Camera/Cable Bundle, includes 30' of cable	VWC900100	\$159.00
In Command	Camera/Cable Bundle with 4 input monitor harness, includes 30' of cable	VWC800104	\$299.00
	Add-On Camera/Cable Bundle, includes 30' of cable	VWC900100	\$159.00
Case-IH/New Holland		Product ID	Price
PRO 700; Intelliview III, IV	Camera/Cable Bundle with 1 input monitor harness, includes 30' of cable	VWC809000	\$199.00
	Camera/Cable Bundle with 3 input monitor harness, includes 30' of cable	VWC801200	\$318.00
	Add-On Camera/Cable Bundle, includes 30' of cable	VWC900100	\$159.00
PRO 1200	Camera/Cable Bundle with 2 input monitor harness, includes 30' of cable	VWC803100	\$229.00
	Add-On Camera/Cable Bundle, includes 30' of cable	VWC900100	\$159.00
Pro 700+, Pro 1200(2025 & newer)	Camera/Cable Bundle with 4 input monitor harness, includes 30' of cable	VWC800105	\$299.00
	Add-On Camera/Cable Bundle, includes 30' of cable	VWC900100	\$159.00
Flagship Combines 2014 to 2021 camera ready	Camera/Cable Bundle with adapter to connect to existing inputs, 2 behind drive tire on left side, 1 in grain tank, includes 30' of cable	VWC803000	\$199.00
Flagship Combines 2022 & newer camera ready	Camera with adapter to connect to connect to existing inputs, 2 behind drive tire on left side, 1 in grain tank.	VWC803010	\$199.00
Mid-Range Combines 2014 & newer camera ready	Camera/Cable Bundle with adapter to connect to existing inputs, 2 behind drive tire on left side, 1 in grain tank , includes 30' of cable	VWC804000	\$199.00
FM1000, XCN2050, FM750	Camera/Cable Bundle with adapter, XCN2050 requires TM-200 module, others connect to input(s) on display, includes 30' of cable	VWC802000	\$199.00
Cat		Product ID	Price
Cat D Skid Steer camera ready	Camera with adapter to connect to existing inputs	VWC811000	\$229.00
Claas		Product ID	Price
Lexion Combines 670-780 camera ready	Camera/Cable Bundle with adapter, includes 30' of cable	VWC802110	\$199.00
Jaguar Choppers 930-980, 880-840 2015 & newer camera ready	Camera/Cable Bundle with adapter, includes 30' of cable	VWC802120	\$199.00
John Deere		Product ID	Price
R-Series Tractors 6000R, CommandCenter display	Camera/Cable Bundle with adapter to connects to socket between controls & window, includes 30' of cable	VWC801600	\$259.00
R Series Tractors camera ready CommandCenter or 2630/4640/G5 Plus	Camera/Cable Bundle with adapter to connect to 4-pin connectors behind panel under back window, includes 30' of cable	VWC807000	\$199.00
S-Series Combines 2016 & prior camera ready	Camera/Cable Bundle with adapter to onnect to 4-pin connectors found on right side of cab, includes 30' of cable	VWC807000	\$199.00
S-Series Combines 2017 & newer camera ready	Camera with adapter to connect to existing inputs,1 on rear of machine, 1 on auger, 1 in grain tank	VWC805000	\$199.00
R-Series Sprayers R4000 (early)	Camera/Cable Bundle with 2 input harness to connect to 6 pin connector behind panel under back window, includes 30' of cable	VWC805100	\$229.00
	Add-On Camera/Cable Bundle, includes 30' of cable	VWC900100	\$159.00

# GPS/OEM SYSTEM CAMERA ADAPTER KITS *CONTINUED*

John Deere Cont.		Product ID	Price
R-Series Sprayers R4000 (late), 400R, 600R	Camera/Cable Bundle with adapter, to connect to 4-pin connectors behind panel under back window , includes 30' of cable	VWC807000	\$199.00
2630 universal stand alone display	Camera/Cable Bundle with 3 input monitor harness, includes 30' of cable	VWC800106	\$279.00
	Add-On Camera/Cable Bundle, includes 30' of cable	VWC900100	\$159.00
4640, G5 Plus universal stand alone displays	Camera/Cable Bundle with 3 input monitor harness, includes 30' of cable	VWC800111	\$279.00
	Add-On Camera/Cable Bundle, includes 30' of cable	VWC900100	\$159.00
Gen 5 standard universal stand alone display	Camera/Cable Bundle with adapter that pins into harness going into back of display, includes 30' of cable	VWC800107	\$199.00
	Camera/Cable Bundle with adapter, requires John Deere harness BPF11638, includes 30' of cable	VWC800108	\$199.00
Outback, Raven, TeeJet, Trimble, Voyager		Product ID	Price
Outback Max	Camera/Cable Bundle with adapter, requires Outback harness 051-0285-000, includes 30' of cable	VWC808300	\$199.00
Raven Viper 4, CR12+	Camera/Cable Bundle with 4 input monitor harness, includes 30' of cable	VWC800109	\$299.00
TeeJet Matrix Pro	Camera/Cable Bundle with adapter, includes 30' of cable	VWC808100	\$199.00
Trimble FMX1000, TMX2050, CFX750	Camera/Cable Bundle with adapter, includes 30' of cable	VWC802100	\$199.00
Voyager	Camera/Cable Bundle with adapter, includes 30' of cable	VWC800110	\$199.00

## READYVISION CAMERAS

View Wirelessly on Your Phone or Tablet!



### Heavy-Duty Wi-Fi Camera

**\$179**



- 12V Constant Power Supply
- Night Vision (6-Infrared LEDs)
- 65lb Magnet Base & Universal Mount



The ReadyVision heavy-duty metal housing camera, with a constant power supply connector and AC/DC adapter, can be operated continuously. It also has an optional magnet base included as well as an external antenna for longer range.

ReadyVision WiFi Wired Camera		
Description	Product ID	Price
Camera, Wired	RVC100000	\$179.00



### Battery-Powered Wi-Fi Camera

**\$199**



The ReadyVision Battery-Powered Wi-Fi Camera features a rechargeable internal battery pack that is capable of powering the camera for up to eight hours without recharging. It includes an AC/DC adapter and 12V power lead, so you can power this camera without the need to recharge the battery.

ReadyVision WiFi Battery Camera		
Description	Product ID	Price
Camera, Battery	RVC200000	\$199.00

- Internal Rechargeable Battery
- Two Power Sources
- Built-In Magnet Base
- Night Vision (8-Infrared LEDs)



ReadyVision WiFi License Plate Camera		
Description	Product ID	Price
Camera, License Plate	RVC300000	\$99.00



**NOTE: Real-Time Video Is Not Guaranteed** The FPS (circled at right) indicates your frames per second. If this is lower than 20, you will NOT have "Real Time" video and should NOT use this camera to safely back up a vehicle. We cannot control how many apps you have open or the speed your device is using to process the video. We also cannot guarantee that you will always have a strong signal.



# LANDBOUW REPLACEMENT PARTS

**A Smarter, Longer-Lasting Solution for Corn Head Replacement Parts!**

## Built for Harsh Harvest Conditions

LANDBOUW parts are made from high-density, impact-resistant poly that stands up to years of wear without cracking, rusting, or denting. They're designed to keep going long after metal parts fatigue.

## Smoother Feeding. Less Crop Loss.

The slick poly surface reduces friction, preventing crop material from bunching or sticking.

## Lightweight, Heavy-Duty Performance

Poly components reduce overall header weight, lowering stress on your equipment. Lighter parts help improve handling and can reduce fuel consumption, without sacrificing durability.

## A Cost-Effective Upgrade Over OEM

OEM tin and plastic parts are expensive to replace. LANDBOUW gives growers a high-quality alternative that lasts longer and installs easily, all while saving money.

## Made in the USA

Manufactured by Lanbouw, POLYTIN replacement poly delivers the quality and reliability farmers expect, backed by American craftsmanship.

## POLY SNOUTS AND DIVIDERS



**HRV829764**

30" Center Poly Snout w/Point Replacement, mounts to OEM steel divider



**HRV810906**

30" Center Divider Hood



**HRV815043**

RH Fender Snout Assembly, JD Green



**HRV860065**

30" Center Poly Divider Replacement

John Deere	Description	OEM ID	Product ID	Price
443, 643, 843, 1243, 653, 853, 1253, 653A, 853A, 1253A	30" Center Poly Snout w/Point Replacement, mounts to OEM steel divider	AH129764	HRV829764	\$193.61
443, 444, 643, 644, 843, 844, 1243, 1244	RH Fender Snout Assembly, JD Green	AH115403	HRV815043	\$275.00
	LH Fender Snout Assembly, JD Green	AH115403	HRV815403	\$275.00
444, 644, 844, 1244	Wide Row Center Snout w/Point Replacement, mounts to OEM steel divider	AH129766	HRV829766	\$227.42
693, 893, 1293 SN (695301)	30" Center Poly Snout Replacement	AH168313	HRV868313	\$255.00
693, 893, 1293 SN (695300)	30" Center Poly Snout Replacement	AH146577	HRV846577	\$235.00
693, 893, 1293	30" Center Poly Divider Replacement	AH160065	HRV860065	\$275.00
606, 608, 612, 616, 706, 708, 712, 716, C6R, C8R, C12R, C16R	30" Center Snout with wear strips	AXE10905	HRV810905	\$295.00
	30" Center Divider Hood	AXE10906	HRV810906	\$295.00
Case-IH	Description	OEM ID	Product ID	Price
843, 863, 883, 943, 963, 983, 1043, 1063, 1083	30" Center Snout w/ Point, IH Red	176228C94	HRV176228	\$285.00
	RH Fender Assembly, IH Red	176234C94	HRV126234	\$396.52
	LH Fender Assembly, IH Red	176233C94	HRV176233	\$396.52
2206, 2208, 2212, 2406, 2408, 2412, 2606, 2608, 2612, 3206, 3208, 3212, 3406, 3408, 3412	30" Center Snout, poly only, reuse original metal frame	86980207	HRV869802	\$275.00
	30" Center Divider, poly only, reuse original metal frame	87028633	HRV870283	\$250.00

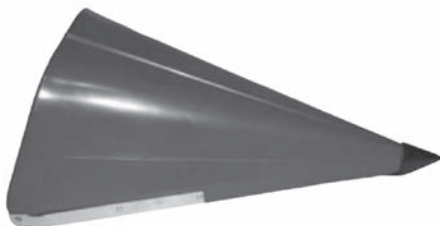

HRV176228



HRV870283



HRV126234

# WEAR STRIPS

These stainless steel wear strips are engineered to dramatically extend the life of your poly snouts, and dividers. By reinforcing the most vulnerable contact points, these wear strips absorb abrasion, deflect impact, and prevent premature cracking, this keeps your plastic parts performing like new, season after season.

Made from high-grade stainless steel, each strip is precisely formed to match the contour of your poly, creating a durable shield in the areas that take the most abuse. Whether you're running through down corn, tough stalks, or debris-heavy conditions, Landbouw wear strips handle the punishment your plastic shouldn't have to.



**HRV110906**  
OE Divider, 30"  
Wear Strip



**HRV141628**  
OE Divider, 30"  
Wear Strip

John Deere	Description	Product ID	Price
493, 693, 893, 1293 SN( -695300)	OE Snout, RH 30"	HRV246577	\$45.00
	OE Snout, LH 30"	HRV146577	\$45.00
	OE Divider, 30" (Stainless Steel 4-1/2" High 16" Long) Requires 2 per row	HRV141628	\$34.00
	OE Fender Snout, RH 30"	HRV268310	\$45.00
	OE Fender Snout, LH 30"	HRV168310	\$45.00
493, 693, 893, 1293 SN(695301- )	OE Center Snout, RH 30-38"	HRV268313	\$45.00
	OE Center Snout, LH 30-38"	HRV168313	\$45.00
	OE Divider, 30" (Stainless Steel 4-1/2" High 16" Long) Requires 2 per row	HRV160065	\$34.00
606, 606C, 608, 608C, 612, 612C, 616, 616C, 706, 706C, 708, 708C, 712, 712C, 716, 716C, 718, 718C, C6R, C8R, C12R, C12F, C16R, C16F, C18R	OE Divider, 30" (Stainless Steel 4-1/2" High 16" Long) Requires 2 per row	HRV110906	\$34.00

# GEARBOX ASSEMBLY

Replacement left hand gearbox assembly for John Deere 40 and 90 series corn heads, and Clarke corn heads. This gearbox is a direct OEM replacement for a much more economical price.

**HRV809794**  
LH Gear Box  
Assembly



John Deere	Description	OEM ID	Product ID	Price
443, 643, 843, 1243, 693, 893, 1293, 694, 894, 1294, CM630, CM830, CM1230, CM1630, CM1830, CM1220, CM1620, CM1820, CM2420	Gear Box Assembly - LH Drive - 40 Series & 90 Series & Clarke Corn Heads	AH209794	HRV809794	\$1,650.00

# STAINLESS STEEL REPAIR KIT

The Stainless Steel Repair Kit reinforces and protects the center divider on your corn head. Instead of replacing worn poly, simply install this durable stainless steel patch to restore strength and extend service life. It can also be added to brand-new poly to prevent early wear and keep your divider performing like new.



**HRV875030**  
Stainless Steel  
Repair Kit

Case-IH	Description	OEM ID	Product ID	Price
2206, 2208, 2212, 2406, 2408, 2412, 2606, 2608, 2612, 3206, 3208, 3212, 3406, 3408, 3412	Stainless Steel Repair Kit - 30", 36", & 38" Row Spacing	87528030	HRV875030	\$62.00

# FLOOR SHEETS

If your grain platform auger trough is showing signs of wear or developing holes, these stainless floor sheets can restore it to "like-new" condition. You can purchase full kits for a complete replacement, or select individual pieces to address only the areas you need. These sheets are durable, easy to install, and built to last.

John Deere	Product ID	Price
915F	SIH010915	\$740.00
918F	SIH010918	\$890.00
920F	SIH010920	\$965.00
922F	SIH010922	\$1,070.00
925F	SIH010925	\$1,260.00
930F	SIH010930	\$1,560.00

Case-IH	Product ID	Price
1020 - 15'	SIH010015	\$820.00
1020 - 16.5'	SIH010016	\$682.00
1020 - 20'	SIH010020	\$1,035.00
1020 - 25'	SIH010025	\$1,085.00
1020 - 30'	SIH010030	\$1,250.00

# IHLE WEAR PARTS

## A Farmer-Built Company

Ihle Fabrications is a farmer-built company in Polk City, IA that is a leading provider in manufacturing agriculture wear parts for combines and other equipment.

Ihle's cutting edge wear part solutions can elevate equipment's performance and durability, ensuring a seamless harvesting experience.

## Transform Your Operations with Ihle Superior Wear Parts

- Enhanced durability with high-grade steel
- A wide variety of wear parts for combines

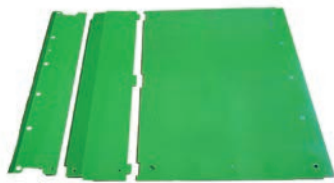

IHL853000

### Ihle Fabrications 24 Month Warranty

Ihle stands behind their product with a 24 month warranty. Their products are made in the USA using the best materials to provide quality combine parts. The products they produce are field tested under real harvest conditions, crafted from OEM specifications to ensure fit, and are built to last.

IHLE FABRICATIONS LLC®



RESTORE. PROTECT. REPAIR.



# HARDOX®

WEAR PLATE

The unmatched strength of Hardox® is an industry-leading wear-resistant steel manufactured by SSAB and its key attributes make it an excellent choice for harvesting applications.

### Unmatched Strength

Allows for increased load-bearing capacity and structural integrity during intense harvesting operations with a nominal hardness of 450 HBW and a yield strength of approximately 1200 MPa.

### Abrasion

Its wear-resistant properties protect combine components from wear, impact, and material loss while extending durability, reducing maintenance costs, and improving overall machine performance.

### Reduced Weight

Hardox® wear steel is lighter weight than traditional steels, contributing to fuel efficiency, and increased payload capacity.

Feeder House	Models	Material	Product ID	Price
Feeder House 3 Piece Liner Kit (Confirm Serial Number)	9660, 9670, 9760, 9770, 9870, S650, S660, S670, S680, S690, S760, S770, S780, S785, S790, S7 700, S7 800, S7 850, S7 900	Hardox® 450	IHL853000	\$1,657.00
Feeder House Liner Kit (9600); Fits AH159704	9600, 9610, 9650	Hardox® 450	IHL859704	\$905.00
6-Piece Drum Wear Plate Kit; Fits AH216876	9670, 9770, 9870, S650, S660, S670, S680, S685, S690	Strenx® 110	IHL816876	\$274.00
8-Piece Drum Wear Plate Kit; Fits AH87970	S650, S660, S670, S680, S690, S760, S770, S780, S790, S7 600, S7 700, S7 800, S7 900	Strenx® 110	IHL887970	\$274.00
Stone Trap Door Liner Kit; Fits AH156157	9650, 9660, 9670, 9750, 9760, 9770, 9860, 9870, 9880, S650, S660, S670, S680, S685, S690, S760, S770, S780, S785, S790, S7 600, S7 700, S7 800, S7 850, S7 900	Hardox® 450	IHL856157	\$233.00
Right Hand Stripper Plate; Fits or Replaces H224463	9670, 9770, 9870, S650, S660, S670, S680, S685, S690, S760, S770, S780, S785, S790, S7 700, S7 800, S7 850, S7 900	Hardox® 500 Tuf	IHL824463	\$93.00
Left Hand Stripper Plate; Fits or Replaces H224463	9670, 9770, 9870, S650, S660, S670, S680, S685, S690, S760, S770, S780, S785, S790, S7 700, S7 800, S7 850, S7 900	Hardox® 500 Tuf	IHL824464	\$93.00
Feed Plate Narrow Seal; Replaces H173904	9450, 9500, 9540, 9550, 9560, 9650, 9660, 9670, 9750, 9770, 9780, 9860, 9870, 9880, S650, S660, S670, S680, S685, S690, S760, S770, S780, S785, S790, S7 600, S7 700, S7 800, S7 850, S7 900	14-Gauge Stainless Steel	IHL873904	\$144.00
Floor Liner; Replaces H174680	9650, 9660, 9670, 9750, 9770, 9860, 9870, 9880, S660, S670, S680, S685, S690, S760, S770, S780, S785, S790, S7 600, S7 700, S7 800, S7 850, S7 900	Hardox® 500 Tuf	IHL874680	\$738.00
Left Hand Floor Liner; Fits H212186	9650, 9660, 9670, 9750, 9760, 9770, 9860, 9870, 9880, S650, S660, S670, S680, S685, S690, S760, S770, S780, S785, S790, S7 600, S7 700, S7 800, S7 850, S7 900	Hardox® 500 Tuf	IHL812186	\$225.00
Auger Grain Bed Liner	Models	Material	Product ID	Price
Shoe Grain Supply Auger Trough Liner Kit; Fits AH146655	9400, 9410, 9450, 9500, 9510, 9550, 9560, 9650, 9660, 9780	14-Gauge Stainless Steel	IHL846655	\$158.00
Clean Grain & Return Grain	Models	Material	Product ID	Price
Clean Grain Trough Liner; Fits AXE15954	S650, S660, S670, S680, S685, S690, S760, S770, S780, S785, S790, S7 600, S7 700, S7 800, S7 850, S7 900	14-Gauge Stainless Steel	IHL815954	\$432.00

# IHLE WEAR PARTS CONTINUED

Threshing Area	Models	Material	Product ID	Price
Backup Strip Discharge Accelerator Beater Kit; Replaces H165408	9650, 9660, 9670, 9750, 9760, 9770, 9860, 9870, S650, S660, S670, S680, S685, S690, S760, S770, S780, S785, S790, S7 600, S7 700, S7 800, S7 850, S7 900	Hardox® 450	IHL865408	\$32.00
Discharge Beater Wear Strip Kit - Long; Replaces H236284	9770, S650, S660, S670, S760, S770, S7 600, S7 700	Hardox® 500 Tuf	IHL836284	\$48.00
Feeder Accelerator & Discharge Beater Blade - Notched, Short; Replaces H165407	9470, 9560, 9570, 9650, 9660, 9670, 9750, 9760, 9770, 9860, 9870, S550, S650, S660, S670, S680, S540, S685, S690, S760, S770, S780, S785, S790, S7 600, S7 700, S7 800, S7 850, S7 900	Hardox® 500 Tuf	IHL865407	\$19.00
Thresher Return Auger Tube; Replaces AXE17790	S680, S685, S690, S780, S785, S790, S7 800, S7 850, S7 900	14-Gauge Mild Steel	IHL817790	\$399.00
Threshing Separator Cover - First Section; Replaces AH233235 or AH208966	9650, 9660, 9670, 9750, 9760, 9770, 9860, 9870, 9880, S650, S660, S670, S680, S685, S690, S760, S770, S780, S785, S790, S7 600, S7 700, S7 800, S7 900	Hardox® 500 Tuf	IHL808967	\$1,667.00
Threshing Separator Cover - Second Section; Replaces AXE10277 or AH233235	S680, S685, S690, S780, S785, S790	Hardox® 500 Tuf	IHL810277	\$2,075.00
Threshing Separator Cover - Second Section - Tailings Return; Replaces AH208575 or AH208573	9650, 9660, 9670, 9750, 9760, 9770, 9860, 9870, S690	Hardox® 500 Tuf	IHL808575	\$2,353.00
Threshing Separator Cover - Second Section - Tailings Return; Replaces AXE24647 or AXE24648	S650, S660, S670, S760, S770, S7 600, S7 700	Hardox® 500 Tuf	IHL824648	\$2,610.00
Threshing Separator Cover - First Section Patch; Fits AH208967 or AH208966	9650, 9660, 9670, 9750, 9760, 9770, 9860, 9870, 9880, S650, S660, S670, S680, S685, S690, S760, S770, S780, S785, S790, S7 600, S7 700, S7 800, S7 900	Hardox® 450	IHL808966	\$330.00
Threshing Separator Cover - Second Section Patch; Fits AXE10277, AH233235, AXE24648, or AXE24647	S680, S685, S690, S780, S785, S790, S7 600, S7 700, S7 800, S7 850, S7 900	Hardox® 450	IHL824647	\$330.00
Counter Knife Housing Pan w/ Advanced Powercast; Fits AXE15810	S670, S680, S685, S690, S760, S770, S780, S790	Hardox® 450	IHL815810	\$667.00
Right Hand Separator Rail Cover - Wide; Replaces HXE149742	S680, S685, S690, S780, S785, S790, S7 800, S7 900	Hardox® 450	IHL849742	\$275.00
Right Hand Separator Rail Cover - Narrow; Replaces HXE149741	S650, S660, S670, S680, S685, S690, S760, S770, S780, S785, S790, S7 600, S7 700, S7 800, S7 900	Hardox® 450	IHL849741	\$250.00
Front Bearing Angle Plate; Replaces H217348	9650, 9660, 9670, 9750, 9760, 9770, 9860, 9870, 9880, S650, S660, S670, S680, S685, S690, S760, S770, S780, S785, S790	Mild Steel	IHL817348	\$575.00
Bubble Up Liner Kits	Models	Material	Product ID	Price
53-1/4" x 12" Bubble Up Liner Kit; Fits AXE56594 or AXE83882	S680, S685, S690, S780, S785, S790	12-Gauge Steel	IHL856594	\$897.00
45" x 11" Bubble Up Liner Kit; Fits AH219094	9650, 9660, 9750, 9760, 9860, S650, S660, S670, S760, S770	12-Gauge Steel	IHL819094	\$482.00
45" x 12" Bubble Up Liner Kit; Fits AXE56593, AXE83881, or AH217983	9770, 9870, S660, S670, S680, S685, S690, S760, S770, S780, S785, S790, S7 600, S7 700, S7 800, S7 850, S7 900	12-Gauge Steel	IHL856393	\$814.00
50" x 10-3/16" Bubble Up Liner Kit; Fits AH135563	9600, 9610	12-Gauge Steel	IHL835563	\$830.00
44" x 9-7/16" Bubble Up Liner Kit; Fits AH135444	9400, 9410, 9500, 9510	12-Gauge Steel	IHL835444	\$830.00
Chopper Outlet	Models	Material	Product ID	Price
Chopper Outlet Housing Liner Kit; Fits AXE78535	S760, S770, S780, S790	Hardox® 450	IHL878535	\$913.00



IHL865407



IHL810277

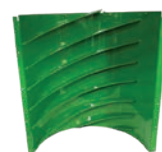

IHL808575



IHL824648



IHL808967



IHL819094

IHL856594



IHL835444

IHL835563



**IHL830013**



**IHL818485**



**IHL869563**



**IHL856760**



**IHL825719**



**IHL828957**



**IHL821044**



**IHL821045**

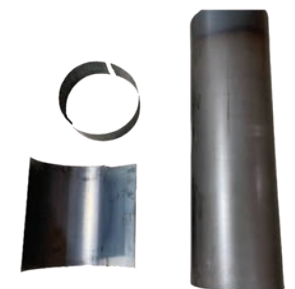

**IHL505000**

Augers	Models	Material	Product ID	Price
Extended Wear Bubble Up Auger; Replaces AH230013	9770, 9870, S660, S670, S680, S685, S690, S760, S770, S780, S785, S790, S7 600, S7 700, S7 800, S7 850, S7 900	Hardox® 450	IHL830013	\$1,100.00
Loading Auger; Replaces AH218485	9450, 9550, 9560, 9650, 9660, 9670, 9750, 9860, S650, S660, S670, S680, S685, S690, S760, S770	Hardox® 450	IHL818485	\$907.00
Powerfold Bubble Up Auger; AXE69563	S660, S670, S680, S685, S690, S780, S785, S790, S7 800, S7 850, S7 900	Hardox® 450	IHL869563	\$1,450.00
Grain Tank Liner Kits	Models	Material	Product ID	Price
Grain Tank Auger Liner Kit; Replaces AH168093	9400, 9410, 9450, 9500, 9510, 9550, 9560, 9600, 9610, 9650, 9660	14-Gauge Stainless Steel	IHL868093	\$625.00
Grain Tank Floor Liner Kit; Replaces AXE56760	S660, S670, S680, S685, S690, S760, S770, S780, S790	14-Gauge Stainless Steel	IHL856760	\$996.00
Corn Head	Models	Material	Product ID	Price
Row Unit Frame Adjustable Deck Plate - LH Side; Replaces AH147773	692, 892, 90 Series	Hardox® 500 Tuf	IHL847773	\$142.00
Row Unit Frame Adjustable Deck Plate; Replaces H154270	692, 892, 90 Series	Hardox® 500 Tuf	IHL854270	\$67.00
Row Unit Snapping Plate; Replaces H225719	600 series, CH2112, CH2208	Hardox® 500 Tuf	IHL825719	\$75.00
Unit Chain Guide Plate - RH Side; Replaces H237437	606, 606C, 608, 608C, 608F, 612, 612FC, 616, 618, 706C, 708C, 708F, 712C, 712F, 716C, 718C, C12F, C12R, C16F, C16R, C18F, C18R, C6R, C8F, C8R	Hardox® 500 Tuf	IHL837437	\$74.00
Hydraulic Row Unit Plate; Replaces AH232250	600, 606, 608, 612, 606C, 608C, 612C, CH2112, CH2208	Hardox® 500 Tuf	IHL832250	\$110.00
Adjustable Snapping Plate; Replaces AH234656	606, 606C, 608, 608C, 608F, 612, 612F, 616, 618, 706C, 708C, 708F, 712C, 712F, 716C, 718C Late Serial (745,000)	Hardox® 500 Tuf	IHL834656	\$104.00
Concaves	Models	Material	Product ID	Price
Round Bar Concave - Front; Replaces AXE28955	9650, 9750, 9660, 9760, 9860, 9670, 9770, 9870, 9880, S650, S660, S670, S680, S685, S690, S760, S770, S780, S785, S790, S7 600, S7 700, S7 800, S7 900	Hardox® 500 Tuf	IHL828955	\$1,010.00
Round Bar Concave - Mid/Rear; Replaces AXE28957		Hardox® 500 Tuf	IHL828957	\$950.00
Tailboard Spreaders	Models	Material	Product ID	Price
Wide Spread Tailboard Twin Disk Blade, LH; Replaces H221044 (QTY 6)	9670, 9770, 9870, S660, S670, S680, S685, S690, S760, S770, S780, S790	Hardox® 500 Tuf	IHL821044	\$1,250.00
Wide Spread Tailboard Twin Disk Blade, RH; Replaces H221045 (QTY 6)		Hardox® 500 Tuf	IHL821045	\$1,250.00
Drago Corn Head Parts	Models	Material	Product ID	Price
Drago GT Series Protector - LH Outside Repair	GT Series	16 Gauge Stainless	IHL434356	\$112.00
Drago GT Series Protector - RH Outside Repair	GT Series	16 Gauge Stainless	IHL435356	\$112.00
Drago GT Series Protector - 2 Piece Inner Row Kit	GT Series	16 Gauge Stainless	IHL424356	\$212.00
Drago Series I & II Protector - 2 Piece Inner Row Kit	Series I & II	16 Gauge Stainless	IHL413435	\$112.00
Gleaner	Models	Material	Product ID	Price
Grain Tank Liner	40, 50 Series	16 Gauge Stainless	IHL415052	\$750.00
Grain Tank Liner	62, 72 Series	16 Gauge Stainless	IHL416052	\$810.00
Cat / Claas / Lexion	Models	Material	Product ID	Price
Narrow Feeder Floor Liner	540, 550, 730, 740, 750, 7500, 8500	Hardox 500 Tuf	IHL520453	\$1,564.00
Wide Feeder Floor Liner	560, 580, 590, 760, 770, 780, 8000	Hardox 500 Tuf	IHL523453	\$1,564.00
Bubble-Up Liner	540, 550, 560, 580, 590, 730, 740, 750, 760, 770, 780, 7500, 8000, 8500	Strenx® 110	IHL505000	\$965.00
Grain Tank Liner	540, 550, 560, 580, 590, 730, 740, 750, 760, 770, 780, 7500, 8000, 8500	16 Gauge Stainless	IHL505200	\$1,065.00